



# Concluding Technical Report

Edited by Anders Ekberg & Björn Paulsson

# **INNOTRACK**

# **Concluding Technical Report**

**Edited by Anders Ekberg & Björn Paulsson**

International Union of Railways (UIC)

Concluding Technical Report  
INNOTRACK, Innovative Track Systems  
[www.innotrack.eu](http://www.innotrack.eu)

Editors:  
Anders Ekberg, Chalmers University of Technology  
Björn Paulsson, UIC / Trafikverket

Layout & production:  
Renée Stencrantz & Jan-Olof Yxell  
Service Department  
Chalmers University of Technology

Printing:  
Intellecta Infolog, Solna, 2010

ISBN: 978-2-7461-1850-8

No part of this publication may be copied, reproduced or distributed by any means whatsoever, including electronic, except for private and individual use, without the express permission of the International Union of Railways (UIC). The same applies for translation, adaptation or transformation, arrangement or reproduction by any method or procedure whatsoever. The sole exceptions – noting the author's name and the source – are "analyses and brief quotations justified by the critical, argumentative, educational, scientific or informative nature of the publication into which they are incorporated" (Articles L 122-4 and L122-5 of the French Intellectual Property Code).

© International Union of Railways (UIC)– Paris, 2010

# Contents

<b>1. EXECUTIVE SUMMARY</b> .....	8
INNOTRACK – a brief summary of highlights .....	10
Evaluating the effects of INNOTRACK .....	19
<b>2. INNOTRACK – WHY AND HOW</b> .....	22
<b>3. COST DRIVERS AND HOW THEY ARE ADRESSED IN INNOTRACK</b> .....	32
3.1 Rail: cracks and fatigue .....	34
3.2 Track Geometry: Poor track support and suboptimal maintenance .....	36
3.3 Substructure: Unstable ground .....	38
3.4 S&C: Switch wear, plastic deformation and cracking .....	40
3.5 S&C: Cracked manganese crossings .....	42
3.6 Rail: Corrugation .....	43
3.7 Poor track geometry – Wrong or unknown stress free temperature (SFT) .....	44
3.8 Rail welds .....	45
<b>4. TRACK SUPPORT AND SUPERSTRUCTURE</b> .....	48
4.1 Subgrade assessment .....	49
4.1.1 The measurement campaigns and database of results .....	50
4.1.2 The concept of onset of settlement .....	54
4.1.3 The concept of track stiffness .....	56
4.1.4 A new tool for track stiffness investigations: the Portancemeter .....	59
4.1.5 Poor quality sites modelling: laboratory experiments & numerical simulations ..	61
4.1.6 Numerical modelling: stochastic approach and accounting for variability ...	63
4.1.7 Variation of track stiffness in transition zones .....	65
4.1.8 Geophysical methods .....	67
4.2 Subgrade improvements .....	69
4.2.1 Improvement of a soft embankment area with inclined lime cement columns ..	70
4.2.2 Improvement of a transition zone using geogrids .....	74
4.2.3 Soil improvement of a bad drainage zone using geogrid .....	77
4.2.4 Feasibility of a ground reinforcement technique using vertical soil-cement columns .....	79
4.3 Superstructure optimisation .....	80
4.3.1 A new slab track design: the Two Layer Steel Track .....	81
4.3.2 Embedded Rail Slab Track .....	85
4.3.3 Developments in numerical simulations of superstructures .....	89
4.4 LCC savings and logistics improvements for substructure and superstructure .....	90
<b>5. RAILS AND WELDINGS</b> .....	96
5.1 Rail degradation and current minimum action rules .....	97
5.1.1 Rail degradation .....	98
5.1.2 “Minimum action” Rules .....	100
5.2 Rail grade selection .....	102
5.3 Deterioration of rails and joints .....	106
5.3.1 Squats .....	107
5.3.2 Corrugation .....	110
5.3.3 Wear .....	113
5.3.4 Insulated joints .....	117
5.3.5 Growth of small cracks .....	120
5.3.6 Large cracks – growth and fracture .....	121
5.3.7 Large cracks – probabilistic approach .....	124
5.4 Rail testing .....	126
5.4.1 Laboratory testing of rails .....	127
5.4.2 Evaluation of contact stresses under laboratory test conditions .....	129
5.4.3 Prediction of rolling contact fatigue (RCF) from laboratory tests .....	131
5.4.4 Characterisation of microstructural deformation as a function of rail grade ..	134
5.4.5 Track tests/track monitoring .....	138
5.5 Inspection and maintenance .....	139
5.5.1 Detection of rolling contact fatigue in rails .....	140
5.5.2 Grinding .....	143
5.5.3 Friction management .....	145
5.6 Rail welding .....	146
5.6.1 Aluminothermic welding .....	148
5.6.2 Flash butt welding .....	151
5.6.3 Gas pressure welding .....	154
5.7 Main influencing variables on the logistics chain of rail supply .....	155
<b>6. SWITCHES &amp; CROSSINGS</b> .....	158
6.1 Optimisation of switches and crossings .....	158
6.1.1 Identifying the major cost factors of switches .....	159
6.1.2 Optimisation of switches and crossings .....	161
6.1.2.1 Switch panel – stiffness and geometry .....	161
6.1.2.2 Crossing panel – stiffness and geometry .....	164
6.1.2.3 Crossing panel – material selection based on sim. and lab tests ...	166
6.1.3 Optimised results used in demonstrators .....	168
6.1.4 Parallel measures .....	170
6.1.4.1 Benchmark of frog materials on a test rig .....	171
6.1.4.2 Stiffness measurements with RSMV car at DB .....	172
6.2 Control and monitoring of switches and crossings .....	174
6.2.1 Functional requirem. for an open standard interface for electronic interlocking	175
6.2.2 Hollow sleeper .....	177
6.2.3 Technical and RAMS requirements / recommendations for actuation systems	179
6.2.4 Switch monitoring systems .....	181
6.3 Benefits from innovative switches & crossings .....	185
6.3.1 LCC evaluation of innovative S&C solutions .....	186
6.3.2 Optimised logistics for S&C renewal – contribution to LCC reduction ...	190
<b>7. LOGISTIC IMPROVEMENTS AND IMPROVED RELATION BETWEEN INFRASTRUCTURE MANAGERS AND CONTRACTORS</b> .....	194
7.1 Potential cost savings related to organisational cost drivers .....	195
7.2 Evaluation of logistics of innovative solutions .....	203
<b>8. TECHNICAL AND ECONOMICAL ASSESSMENT</b> .....	208
8.1 RAMS and LCC analysis for rail infrastructure .....	209
8.2 RAMS technology .....	212
8.3 LCC analysis and models .....	216
8.4 Definition of boundary conditions .....	221
8.5 Processing and determination of LCC data .....	223
8.6 Technical verifications .....	228
8.7 Economical verifications .....	229
<b>9. OVERALL COST REDUCTION</b> .....	232
9.1 Savings in sub grade treatments, soil strengthening .....	234
9.2 Savings on switches and crossings (S&C) .....	236
9.3 Approach to assess rail related cost savings .....	238
9.4 Conclusions from “Overall Cost Reduction” .....	242
<b>10. DISSEMINATION AND IMPLEMENTATION</b> .....	246
<b>11. CONCLUDING REMARKS</b> .....	254
<b>APPENDIX I – LIST OF INNOTRACK PARTNERS</b> .....	260
<b>APPENDIX II – INNOTRACK DELIVERABLES</b> .....	262
<b>APPENDIX III – INNOTRACK DATABASES</b> .....	270
<b>APPENDIX IV – INNOTRACK GUIDELINES</b> .....	272
<b>APPENDIX V – INNOTRACK RELATED PUBLICATIONS AND PRESENTATIONS</b> .....	274
<b>APPENDIX VI – A LIST OF IMPLEMENTABLE RESULTS FROM INNOTRACK</b> .....	276

# EXECUTIVE SUMMARY 1

# EXECUTIVE SUMMARY

## INNOTRACK Objectives

The INNOTRACK project has been a joint response of the major stakeholders in the rail sector – infrastructure managers (IM), railway supply industry and research bodies – to further develop a cost effective high performance track infrastructure by providing innovative solutions towards significant reduction of both investments and maintenance related infrastructure costs.

INNOTRACK has been a unique opportunity to bring together rail IM's and industry suppliers and to concentrate on the research issues that has a strong influence on the reduction of rail infrastructure life cycle cost (LCC). INNOTRACK has been founded by the EC commission under the 6th Framework Programme, contract no TIP5-CT-2006-031415. ■

## The philosophy of INNOTRACK

### The future importance of the railways can increase if the new demands on the railway can be met – tools to meet many of these demands are handled in INNOTRACK

Today the railways are facing new demands. Examples are higher speeds and higher axle loads (often in combination), higher availability, fewer disturbances and reduced LCC. At the same time environmental demands and safety requirements must be fulfilled. Most railways have also many bottlenecks where there are very small margins for disturbances. If these new demands can be met, the future importance of the railways can increase. The results from INNOTRACK will help the railways tackle these issues in the important area of track and substructure. This part represents 50–60% of the maintenance and renewal costs of a typical railway. This means that the results from INNOTRACK have a significant impact on the overall cost reduction for the railways.

These challenges are described more in detail in chapter 2. It is important to understand that all these demands and challenges are not only empty phrases, but a reality in the everyday operations of the railways.

The result from INNOTRACK is like a toolbox with many innovative solutions. Some selected solutions are presented as “highlights” in this chapter in order to give an overview of the contents of INNOTRACK. Some of these highlights are very technically oriented, while some are of a more overall nature. In addition there is a full list of implementable results from INNOTRACK presented in APPENDIX VI. ■

## The railway system is very complex

The main reason for the complexity of the railway system is that it often is a mixture of components of different age and status that have to work together in a system. Replacement of components is also a continuous and ongoing process. Today the railway infrastructure is therefore like a patchwork that has to perform to higher demands. For this reason changes have to be carefully executed.

Another important factor is that a significant part of the knowledge regarding railways in general, and track structures in particular, is empirical. This means that we know what will happen if the situation is static, but if we have to meet new demands there will often be a radical change in the system response. For this reason we must not only know “how” (as is currently the common case), but also “why” in order to predict the effect of changes. In INNOTRACK a lot of new knowledge is brought forward to understand exactly “why” phenomena occur to make it possible to predict the future response of the track structure.

To change (or rather to upgrade) parts of the system with new, better performing components means that the new components must fit in the complex railway

system. To introduce new components is a necessity since many old components need replacement and/or cannot meet new demands. However, in order to avoid a situation of trial-and-error, there is a need to make this introduction in an ordered fashion where it is ascertained that technical, LCC and logistics demands are met. This process has also been a focus of INNOTRACK.

To further complicate the situation, there is a trend (generally positive) that the components are becoming more and more international. Further, the role of the industry in developing new products has changed and is changing even further, see chapter 7. This means that new components are to less extent tailored for specific national needs. Further, the IM has less control of the development of the products, but must set their specifications based on functional requirements. This puts new demands on both IM and industry in assuring that components have a correct quality and can perform in the railway system in an expected way. INNOTRACK has scrutinized this issue from both a technical and an LCC point of view. ■

## Most cost drivers are international

Investigations in INNOTRACK have shown that the most important cost drivers are international. Therefore several proposed implementation projects would be more efficient if they were carried out in an international cooperation. If it is possible to create active international working groups, the implementation of new solutions will go faster and require fewer resources.

INNOTRACK has for the first time identified the European track related cost drivers and their root causes in the areas of substructure, track and s&c. Further, INNOTRACK has been and is actively engaged in aiding and coordinating implementation on a European level. ■

## Research and development is a necessity and an efficient way of progressing, especially in the railway area

Today research and development (R&D) in the railway area is a necessity to achieve cost reduction and better performance. It is also a good way to cooperate between IM's and the industry so that the needs of the IM can be matched to the product development in the industry, and to ensure that the developed products/services/processes fit in the system and perform in the intended manner.

This is still more important since a larger part of R&D today is done in different environments where the industry's part is successively increasing and today is considered to have passed the IM's in volume. ■

## Implementation of new knowledge is difficult but a necessity

It has traditionally been difficult to implement new knowledge in the railways. It is today the Achilles heel of R&D. Here the IM's must become more efficient and assure that if a new product is introduced this introduction is carried out in an ordered fashion (see above) and that also

the knowledge related to this product is incorporated in the organisation. In INNTRACK considerable resources have been allocated from UIC and UNIFE to support implementation in a more professional manner. ■

# INNTRACK —a brief summary of highlights

### Subsoil assessment

#### Cost driver

Variability in soil conditions leads to unstable track geometry and high needs for maintenance.

#### Solution

INNTRACK has carried out a comparison between several assessment methods for subsoil conditions to evaluate their capabilities and accuracy. In addition, a database for storing, finding and visualizing data on subsoil conditions has been developed.

#### Benefits

Possibility to optimize reinforcement efforts, which reduces track geometry degradation and need for tamping.

#### Next steps

Optimized use of national assessment methods internationally “with the definition of assessment methodology”. Wider use and addition of further data to the developed track condition database. Evaluation of time dependence of track conditions.

### Track stiffness

#### Cost driver

Track stiffness is an important factor in the interaction between train and track. In simplistic terms the track stiffness governs the track's impact on the vehicle. This is especially crucial for high-speed and heavy-freight operations. It should here be noted that it is normally not the specific stiffness that is of most importance,

but rather the variation of the stiffness. Further, the track stiffness has a natural variation due to climate. Varying too low or too high track stiffness leads to higher dynamic loads, which is an important cost driver.

#### Solution

INNTRACK has taken a significant step forward in concluding the question. Techniques have been developed for measuring and evaluating track stiffness. Through this the understanding of the influence of track stiffness has been increased, which has made it possible to optimize the track stiffness distribution. INNTRACK has further, for the first time, carried out international comparisons of variations of track stiffness in switches. The results clearly show the significant potential for reducing dynamic forces. The measurements demonstrated in INNTRACK give a tool for monitoring and maintaining proper stiffness distributions in switches, but also e.g. in transition zones.

Development and evaluation/comparison of several track stiffness measurement methods has been performed in INNTRACK. To assess the influence of varying subsoil conditions, INNTRACK has further developed and evaluated a number of numerical and experimental techniques and methods.

#### Benefits

Better knowledge of the track stiffness gives the potential to lower dynamic forces and reduce degradation of track and s&c.

#### Next steps

Track stiffness has a strong influence on the loading of the track and rolling stock. Track stiffness is still an open question in the TSI Infrastructure. The result from INNTRACK can be a good input to enhance the TSI.

The results from INNTRACK will further be used to optimise s&c.

## Four different methods for subgrade improvements

### Cost driver

Improving subgrade conditions is very costly. These costs relate not only to manpower and materials etc, but also to costs for traffic disturbances, speed regulations etc.

### Solution

INNTRACK has developed, implemented and evaluated four different methods for subgrade improvements. These include an optimized use of geo-grids and geotextiles, the use of vertical soil-cement columns, and the use of inclined lime-cement columns. The latter method has been applied without the need to close down the track, which leads to significant cost savings and minimal traffic disruptions. All these methods have been verified by numerical simulations/calculations and/or experimental tests.

### Benefits

The improved and optimised methods will, as have been demonstrated, decrease LCC significantly. It will further decrease operational disturbances.

### Next steps

The developed solutions need now be integrated in national and international regulations.

## Two innovative track-forms

### Cost driver

Variation in the support stiffness of track is a key contributor to more rapid degradation of track quality and rail integrity. Consequently, the track requires more frequent tamping to correct the line and level, rail grinding to remove surface defects such as rolling contact fatigue, and non-destructive testing of the rail to prevent rail breaks and ensure safe operations. The situation is further exacerbated for s&c units because of the complexity of layouts and the associated higher dynamic forces.

Consequently, the key driver for the development of new track forms was to reduce life cycle cost of track by engineering out variability through design and installation techniques.

#### **Solution**

Two innovative track forms have been developed in INNTRACK:

##### *The Embedded Rail System*

The system features high productivity construction with sequential high output concreting, alignment and railing. Up to 1.5 metres per minute for a high speed railway. No tamping or ballast costs. An innovative rail shape that allows 25% more rail wear and a full use of harder rail steels. A vehicle interactive design to minimize rolling stock costs. The continuously supported simple low component system provides support for fully automated vehicle-borne inspection including video, ultrasonic and geometry. There is also a potential for full fibre optic sensing in the slab for settlement.

##### *The Two-Layer Steel Track*

This system has been specifically designed for switch & crossing layouts that consume a highly disproportionate amount of the track maintenance budget. The steel – concrete 2 Layer track is a novel track design that has been taken from concept to prototype installation within the project. It features a consistent support through design to minimise maintenance requirements. It is a modular construction that facilitates rapid installation, which leads to reduced installation time and costs.

#### **Benefits**

##### *Embedded Rail System*

High productivity construction with 30% reduced construction time, reduced construction cost – competitive with ballast, Low cost construction equipment from road industry. The solution also features

increased tunnel clearances with a low construction depth. Maintenance is reduced with improved vehicle interaction, no ballast maintenance, increased rail life (fatigue and wear) and 60 years plus life of track. Facilitates automated inspection with full ultrasonic inspection. It also allows for fully automated video/geometry inspection by design. In addition several failure modes have been eliminated.

##### *Two Layer Steel Track*

The two-layer design ensures consistency of support and adjustability. The modular construction with a panel-based design enables rapid and cost effective installation and logistics. It provides the ability to open at line speed at handover after each possession. The degradation of support is significantly reduced resulting in minimum maintenance (no tamping) and increased track availability. Further, the more consistent support and rail – wheel contact conditions leads to an increased rail life. Installation costs are comparable to ballasted track s&c when train delay costs are taken into account.

#### **Next steps**

The solutions are now being implemented in operations.

#### **A guideline for optimum selection of rail grades**

##### **Cost driver**

The undifferentiated use of conventional (non-heat treated standard carbon) rail steels in curves up to 5.000 m results in avoidable excessive maintenance cost and/or premature re-investment cost for exchanging the rails.

#### **Solution**

Based on a multitude of long-term track measurements INNTRACK has been able to develop and calibrate predictive models for overall rail degradation in terms of wear and rolling contact fatigue (RCF). Compared to standard rail grades, heat-

treated rails show a superior wear and RCF resistance. Two different rail grade selection recommendations – a “radii based” recommendation and a “deterioration based” approach – were worked out. Both methods have led to consistent results that confirm the technical and economic advantages of the extensive utilisation of heat treated premium steel grades.

#### **Benefits**

The improved rail durability by a shift towards heat treated premium steel leads to a significantly extended service life, substantially reduced life-cycle cost and, at the same time, to an increased operational availability of the track. Also the payback of the incremental investment can be achieved in a very short time. Respective cost-savings can be specifically calculated by using the LCC model developed in INNTRACK, as has been shown in the project.

#### **Next steps**

The guideline developed in INNTRACK is now employed by the UIC Track Expert Group and is proposed to form the basis for a UIC/UNIFE TecRec (replacing the UIC leaflet 721).

#### **Squat formation**

##### **Cost driver**

Squats are becoming increasingly more common on the European network. Remedial maintenance actions of grinding, weld restoration, or replacement of a short length of rail containing the defect have a significant impact on the maintenance budget.

#### **Solution**

The knowledge of causes of squat formation and the factors affecting growth need to be enhanced so that optimized mitigating actions can be applied. The work in INNTRACK has been a significant step in this direction by the use of field measurements and numerical simulations. In

particular, the question of which initial defects that will propagate to form full-scale squats has been thoroughly investigated.

#### **Benefits**

The work in INNTRACK provides means in optimizing maintenance actions and will facilitate a move to planned maintenance. The magnitude of maintenance cost reduction will be influenced by track and traffic characteristics but is expected to be significant.

#### **Next steps**

The gained knowledge needs to be incorporated into operational codes and “minimum action” handbooks. The conclusions are mainly based on observations on the Dutch network. The study needs to be expanded to examine if the findings are equally applicable in other European networks. There is still a major need for further knowledge, e.g. regarding growth rates under general operating conditions.

#### **Corrugation**

##### **Cost driver**

Corrugation increases noise emission levels and wheel–rail contact forces. The standard mitigating action is grinding, which is costly and causes traffic disturbances. There is also some evidence for increased susceptibility of corrugated track to squat defects.

#### **Solution**

INNTRACK has developed a method to determine allowable corrugation magnitudes with respect to noise pollution and risks for the formation of wheel and rail cracks.

#### **Benefits**

The numerical toolbox that has been developed can be employed to determine grinding intervals etc.



### **Next steps**

The derived knowledge needs to be established in operational codes, “minimum action” handbooks and practices. To further optimize maintenance actions, deeper knowledge on corrugation growth and the relationship between operational loading conditions and crack formation would be valuable.

### **Insulated joints**

#### **Cost driver**

Insulated joints impose a discontinuity in the rail. Due to this they will be subjected to high operational loads that may cause joint dips (leading to even higher loads) and material rollout (causing short-circuiting of the signalling system). The remedial actions, unless detected at early stages of deterioration, often result in replacement and hence add significantly to maintenance costs and causes traffic disturbance.

#### **Solution**

INNOTRACK has carried out an extensive simulation campaign on the mechanical deterioration of insulated joints. In addition, field measurements have been made in order to verify simulations. The result is a significantly improved understanding of the influence of various operational parameters and the associated deterioration mechanisms.

#### **Benefits**

The work in INNOTRACK lays the foundation for prescribing joint geometry and allowable tolerances for different operational conditions. Furthermore, the improved understanding of deterioration mechanisms are also expected to contribute to improved designs of insulated joints.

### **Next steps**

The derived knowledge needs to be established in operational codes, “minimum action” handbooks and practices. Further increased knowledge is needed, e.g. regard-

ing the influence of traffic situation, support conditions, material characteristics etc.

### **Rail cracks**

#### **Cost driver**

Cracks in rails are ultimately a safety problem. In order to prevent cracks to grow to failure, they need to be detected and mitigated in the early stages of growth. Further excessive overloads need to be avoided. Lack of accuracy in preventive measures, including the permissible passing loads, lead to increased costs and/or decreased levels of safety.

#### **Solution**

The growth of rail cracks has been studied in INNOTRACK with the aim of quantifying the influence of operational parameters and in predicting inspection and maintenance needs. An example of use is the identification of allowable load magnitudes induced by wheel flats.

#### **Benefits**

With the work in INNOTRACK, the accuracy of operational decisions and mitigating actions has increased. A particular benefit is that existing “minimum actions” can be examined and verified/revised using scientifically proven techniques.

#### **Next steps**

The results from INNOTRACK have already been employed for better regulations regarding operational loads. Harmonization on a European scale is needed. Furthermore, the work related to inspection intervals needs to be implemented in “minimum action” handbooks and codes and the technique extended to other key defects encountered on European networks.

### **Rail tests**

#### **Cost driver**

Good tests of rail grades promote the development of suitable rail grades and pertinent maintenance strategies. This will decrease maintenance costs. Field tests are

very costly and hard to carry out under controlled conditions. If laboratory tests can replace these significant cost savings will be obtained. However, the current European rail standard (prEN 13674: 2009) does not include any direct measure of the various rail grades to the two key rail degradation mechanisms of wear and rolling contact fatigue (RCF). Instead, the standard and the railways rely on the indirect measures of surface hardness and tensile strength. Furthermore, the current tests for wear and RCF undertaken by various organisations (IM’s, rail manufacturers, and academia) are not comparable and only provide an indication of the operational performance of the various rail grades. All of these factors lead to less efficient and more costly tests than needed and can contribute to the non-optimum selection of rail grades.

#### **Solution**

INNOTRACK has carried out work on harmonizing laboratory tests of rail grades (scaled and full-scale) and relating these to in-field operational conditions by the use of numerical simulations and laboratory investigations of micro-structural deformation/damage. The systematic approach adopted is unique in the railway world and the results have provided further scientific evidence of the benefits of premium steel grades.

#### **Benefits**

The work in INNOTRACK has provided a methodology of comparison of rail grades and the guideline produced is expected to be included in future Euronorm rail specifications.

#### **Next steps**

The work carries on both in formalizing and standardizing reporting of tests (also field tests) and in improving the methods of comparing test and operational conditions through numerical simulations and microstructural deformation / damage investigations.

An initiative will be taken to have this as an important input to a new CEN standard.

### **Inspection methods and equipment to detect rail cracks**

#### **Cost driver**

Inability to detect rail cracks at an early stage of growth hinders the planning of mitigating actions such as grinding. It may also lead to that cracks are allowed to grow too long before removal, which leads to higher grinding costs and more operational disturbances, and also to a shorter rail life. In severe cases this may even be a safety issue.

#### **Solution**

A significant number of inspection methods and equipment to detect rail cracks have been tested in INNOTRACK. The different methods have been compared with respect to accuracy for different types of cracks. The equipment has been evaluated in laboratory conditions, as well as in field.

#### **Benefits**

The work in INNOTRACK provides an IM with a good basis to select suitable equipment to detect rail cracks.

#### **Next steps**

The work is continuing in the European projects INTERAIL and PM ‘n’ IDEA.

### **Grinding procedures**

#### **Cost driver**

Grinding is a necessary maintenance method used to increase rail life and reduce costs. Grinding costs are today high. Two reasons for this are poor logistics planning and lack of network grinding strategies.

#### **Solution**

INNOTRACK has delivered a guideline on optimized grinding procedures. This guideline includes not only technical specifications (e.g. profile tolerances), but also logistical and strategic considerations.

### **Benefits**

The INNOTRACK guideline gives support in deciding target profiles. It also aids an IM in optimising grinding from a logistics perspective and to impose a clear grinding strategy for the whole network.

### **Next steps**

The work is continued in a group that will make a TecRec based on the INNOTRACK guideline. The new TecRec shall be expanded as compared to the guideline in the following areas: How a strategy shall be implemented, logistics aspects, economical aspects, coordination with other maintenance activities, and harmonisation of target profiles.

## **Welds with a narrow heat affected zone**

### **Cost driver**

The welds form a disturbance in the track properties. This may lead to increased loads, which promote rail degradation. Further, welding consumes significant amounts of energy, which is relevant both from an LCC and an environmental perspective.

### **Solution**

INNOTRACK has developed and evaluated the benefits of welds with a narrow heat affected zone.

### **Benefits**

The narrow heat affected zone welds are superior from an energy management perspective. In addition, INNOTRACK has evaluated the beneficial mechanical properties of the narrow heat affected zones.

### **Next steps**

The narrow heat affected zone welds need now be wider deployed in operational services and national and international regulations adopted to account for the findings from INNOTRACK.

## **Charting of cost distributions**

### **Cost driver**

Lack of a standardized way of keeping track of costs and relating them to components, work tasks etc, prevents an identification of cost drivers and an LCC optimization of the network.

### **Solution**

INNOTRACK has carried out a charting of main cost drivers on a European scale and detailed charting of the distribution of costs related to track, switches and crossings. This charting has showed where the potentials for cost savings are. Further INNOTRACK has proposed a framework for a unified cost breakdown structure.

### **Benefits**

Based on the identified cost drivers in INNOTRACK, the work on decreasing LCC can be carried out in an efficient manner. Further, unifying cost structures promote international cooperation and exchange of information and knowledge.

### **Next steps**

The work in INNOTRACK is a first step. To gain general acceptance there is a need to bring the work forward in standardization bodies.

## **Optimizations of switches & crossings**

### **Cost driver**

Switches & crossings (s&c) are discontinuities in the track systems. They impose dynamic loads on track and rolling stock and are prone to mechanical failures.

### **Solution**

Through numerical simulations calibrated from in-field measurements, INNOTRACK has been able to propose several measures to optimize the mechanical characteristics of s&cs and thereby decrease their detrimental influence. These measures include gauge widening, optimized track stiffness and component geometries.

### **Benefits**

The innovative solutions promote a decrease in operational loads that will decrease the deterioration of the s&c as well as the detrimental influence on passing vehicles.

### **Next steps**

The proposed measures are now under full-scale validation. Results so far indicate a significantly increased performance of the optimized s&cs.

## **Numerical damage prediction and optimization of switch components**

### **Cost driver**

Switch components are highly dynamically loaded components in the track system and therefore prone to damage, which requires costly maintenance and/or replacement, often involving significant traffic disruptions.

### **Solution**

INNOTRACK has for the first time ever demonstrated a methodology to numerically predict the detailed deterioration in terms of plastic deformations, wear and rolling contact fatigue of an operational crossing nose. To carry out this, a multitude of advanced simulation packages had to be combined together with a determination of relevant material properties. Validations towards operational components show a very good accuracy. INNOTRACK has also tested innovative s&c materials in laboratory tests with very interesting results. The framework to implement the mechanical characteristics of these innovative materials in numerical simulations is developed.

### **Benefits**

The result of INNOTRACK is a toolbox that can be used to optimize switch components already in the design stage. This will save significant costs in premature track tests and will lead to optimum choice of both materials and design of switches &

crossings. Furthermore, definition of the required material properties and testing techniques has provided a much needed technique to aid metallurgical design and development of new steels used for the crossing nose and other rail components.

### **Next steps**

Currently the work continues with the analysis of the effect of altered materials. Further full-scale tests including some innovative materials are being carried out to further validate the simulations. The work now needs to continue with the development of optimized solutions and the operational integration of these in switch systems.

## **Open standard for electronic interlocking and hollow sleepers**

### **Cost driver**

The lack of a standardized interlocking interface is currently a hinder for obtaining production scale effects and increase competition within Europe. The same is true for hollow sleepers, where a standard geometry would also promote the adaptation of tamping machines.

### **Solution**

INNOTRACK has proposed an open standard for electronic interlocking. In addition INNOTRACK has proposed a standardized hollow sleeper to house driving mechanisms for switches.

### **Benefits**

As mentioned above, the derived solutions will promote benefits of scale etc. In addition the standardization will facilitate sourcing. For these reasons the standardizations proposed by INNOTRACK are likely to lead to significant costs reductions.

### **Next steps**

The proposed standard on hollow sleeper is now being processed by the CEN. The standardized interlocking interface needs

some further development before being forwarded to standardization bodies.

### Key parameters for switch monitoring systems

#### Cost driver

Unplanned maintenance of switches is costly and leads to traffic disruptions. The problem is further aggravated if there is little information to aid the maintenance staff in locating the error.

#### Solution

Key parameters for switch monitoring systems have been identified in INNOTRACK. Algorithms for fault detection have been developed. To validate the monitoring systems, laboratory and in-field tests have been carried out.

#### Benefits

The work carried out in INNOTRACK will aid in the development of switch monitoring systems that can indicate malfunctioning components and thus decrease time needed for repair. They can also be used to identify evolving faults so that maintenance can be carried out before these become critical and cause a malfunction of the switch.

#### Next steps

The solutions in INNOTRACK need now be further developed and included in commercial products.

### LCC evaluation methodology

#### Cost driver

One of the most significant complications in the introduction of innovative solutions in the track sector is the assessment of their LCC impact. This may lead to incorrect decisions and related increases in costs.

#### Solution

INNOTRACK has developed a stringent, unified methodology for LCC evaluations on a European level. The method provides the ability to evaluate the LCC impact of different scenarios. It further results in well-

defined analyses that clearly define which factors that have been taken into account.

#### Benefits

Apart from providing an objective tool for decision making, the LCC model developed in INNOTRACK will be used for comparisons between different scenarios. Further it can highlight parametric influences such as the effect of adopting different discount rates or delaying interventions.

#### Next steps

The methodology is currently in operational use e.g. at the DB. The further European use is foreseen to lead to improvements such as a more extensive analysis of the influence of statistical scatter and the inclusion of improved models to predict deterioration.

### Logistics solutions

#### Cost driver

The logistics cost drivers comprise management/organisational, strategic and technical issues, such as:

- full or partial lack of track possession policy with a clear plant and staff deployment, and identified minimum disturbance strategies and procedures
- insufficient long-term planning and funding with commitments from governments
- deficiencies in work programming and project management

Further, local rules and regulations are often key barriers to the opening of national markets.

Within INNOTRACK however only technical cost drivers were dealt with.

#### Solution

INNOTRACK has derived solutions which minimise track possession times, allow for maintenance without traffic disruption, provide a high output rates, minimise the impact of rules & regulations by the use of standard machinery. Examples of these are:

From Track Support and Superstructure: inclined cement columns, embedded slab track, and two layer steel slab track.

From Switches & Crossing: implementation of a modular S&C, “plug-and-play”-solutions, and steel slab track.

From Rails & Welding: use of ultra-long rails (up to 120m weld-free), less welding, “just-in-time” direct transportation to construction site, reduced manipulation and stock keeping.

#### Benefits

Estimated savings in LCC is 30%. This includes qualitative estimations, which are however based on a tangible reality and thus considered reasonable.

## Evaluating the effects of INNOTRACK

### Evaluation of logistics benefits

In chapter 7 an overview of currently ongoing changes due to a more international approach in the European railway landscape is described. Also a picture of the present situation is given as background to identify possible ways of improvements related to the identification of logistics constraints and ways to overcome these. The interviews with both contractors and IM's have indicated significant possible

#### Next steps

Key issues often relate to processes, people and culture. A key to success is to build a closer and more open relationship between infrastructure managers, industrial companies and contractors. Important next steps are the joint work groups that have formed between EIM/CER/EFRTC and other associations.

cost reductions solely from mitigating these logistics related issues. Possible improvements include more collaborative, partnership-based approaches aimed at optimizing the use of available possession times, reducing costs and/or delivering more for the available budget and thus increasing the efficiency of providing a railway infrastructure for operators in general. ■

### Technical and economical assessment

Evaluating Life Cycle Cost (LCC) of the asset is an important tool in the decision process. In INNOTRACK this has been addressed in a dedicated subproject. The work is summarized in chapter 8 of this book.

An important result from INNOTRACK is that a harmonized LCC calculation method at a European level has been established. This method enables to identify cost drivers, assess the costs of track components/modules and to make cross-country comparison. In the evaluations it is found that the discount rate has a significant impact on LCC as described and quantified for different situations.

Several complications in carrying out LCC-calculations are clarified. Examples are the relation between technical and economical aspects and how service life is dependent on failure rates for different components in the railway system. Other factors like availability and influence of repair rate are also considered.

Since the significant part of LCC is fixed before the installation phase it is here the largest parts of the savings can be made. This also means that it is very important that IM's give feedback to the suppliers in order to reduce LCC.

RAMS (Reliability, Availability, Maintainability and Safety) evaluations have also been addressed in INNOTRACK. Use of RAMS in the area of track and structures was

## Overall cost reduction

The objectives of overall cost reductions from INNOTRACK are explained in detail in Chapter 2. The work in INNOTRACK has demonstrated that it is not possible to present a common international figure of the total cost reduction related to the solutions developed in INNOTRACK. The reason for this is mainly that every IM has a different maintenance policy and that the costs for maintenance and renewal vary a lot.

Of more interest is perhaps which reduction that can be achieved for a specific railway. This is an important question since the full implementation of result from

## Dissemination and implementation

Many EU-projects end when the project is formally finalised. The reason is simply that there are no economical benefits for many participating members to carry on with the implementation work. For this reason too many EU-projects produce “shelf warmers” that are not operationally implemented. In INNOTRACK it has been an ambition from the beginning to have a focus on implementation. This is the reason for the engagement and contribution with extra resources from the UIC.

During and after the formal end of the project, an extensive work has been carried out to prepare and support implementation of the INNOTRACK results. This

work has engaged many railways both within and outside the INNOTRACK consortium as well as several organisations and regulatory bodies. This is described more in detail in chapter 10.

work has engaged many railways both within and outside the INNOTRACK consortium as well as several organisations and regulatory bodies. This is described more in detail in chapter 10.

work has engaged many railways both within and outside the INNOTRACK consortium as well as several organisations and regulatory bodies. This is described more in detail in chapter 10.

work has engaged many railways both within and outside the INNOTRACK consortium as well as several organisations and regulatory bodies. This is described more in detail in chapter 10.

work has engaged many railways both within and outside the INNOTRACK consortium as well as several organisations and regulatory bodies. This is described more in detail in chapter 10.

found to be in an early stage. Therefore some basic considerations were done and proposals for future development presented. ■

INNOTRACK is a process that will take many years. Which parts and areas shall a specific railway prioritise in this process? Chapter 9 presents a summary of the evaluation of the potential overall reduction in LCC obtained by implementation of a range of INNOTRACK innovations at four IM's.

These evaluations show that the potential LCC reductions are on the order of the set objective. This result is also backed by detailed analyses of some innovative solutions using a standardised LCC process that has been developed within INNOTRACK. ■

work has engaged many railways both within and outside the INNOTRACK consortium as well as several organisations and regulatory bodies. This is described more in detail in chapter 10.

In addition an implementation group has been established based on INNOTRACK Steering Committee and Coordination Group. The aim of this group is to promote and coordinate the Europe-wide implementation of INNOTRACK results. This makes INNOTRACK a unique project in the way implementation is organised. ■

# INNOTRACK 2 – WHY AND HOW 2

# INNOTRACK – WHY AND HOW

## Background

The discussions on what was to become INNOTRACK started in early 2004 when the preparatory work was targeted towards two separate projects. After more than a year, a project proposal was finally delivered to the European Commission in September 2005. The proposal was commented in October and a hearing took place in Brussels in November. A planning meeting with the Commission was held in February 2006 and a draft “Description of Work” sent to the Commission in March 2006. The final “Description of Work” was sent to the Commission in April 2006. The Consortium agreement was sent out for signing in May 2006 and finally the project started at the 1st of September 2006. In all it took 2.5 years to prepare INNOTRACK.

The primary motivation for INNOTRACK was that there is a continuous demand for more cost efficient railways. This should be contrasted with the fact that track costs, the major cost component for Infrastructure Managers (IM’s), have not significantly decreased in the last 30 years. In the same period of time, competing modes of transportation have seen a tremendous reduction of Life Cycle Costs (LCC). This narrows the business case for rail transportation, which has significant repercussion on important societal issues such as environment and safety. For this reason, an R&D project focused on the area of LCC reductions was of the highest priority. The project must deliver results that yield significant LCC reductions and RAMS improvements in order to strengthen the competitiveness of the railway sector.

Rough figures shows that maintenance costs for mixed traffic lines are higher than maintenance costs for lines dedicated to high speed or heavy haul. The reason for this is quite simple. It is possible to optimise a dedicated traffic situation far better

than if you have to make compromises. An illustrative example is that it is not possible to optimise the cant deficiency for faster passenger trains and at the same time fulfil demands from freight traffic. Though somewhat simplistic, this reasoning indicates that considerable cost savings are feasible in the field of mixed traffic. Further, mixed traffic is also the most common traffic situation in the European railway network. For these reasons INNOTRACK has focused on an operational scenario of mixed traffic.

Over many years, a lot of good ideas have been proposed in order to reduce costs and at the same time meet new demands for the railways. Examples of new demands are higher speeds; higher allowed axle loads; better availability; fewer disturbances; higher operational reliability, and more traffic on existing lines. The good ideas brought forward were proposals for improvement of existing methods and products, but also completely new innovative solutions. They stemmed not only from the IM’s, but also from industry, universities and R&D-institutes. Like most new technical ideas they were often questioned from an economical and practical point of view: What effects do the new proposed solutions have on improved performance and reduced costs? Such questions are reasonable, but to be able to respond, a new approach has to be taken. This implies a broader approach to R&D than normally adopted. The aim is to gather hard evidence of technical and economical benefits of innovative solutions so that top management in the railways and in the industry can be convinced of the benefits of the innovative solutions. This broader approach has been adopted in INNOTRACK.

To achieve this broad approach, a matrix organisation was formed. The three technical sub-projects were developed to assess the technical aspects of the innovative solutions. In addition, three sub-projects were

created to gather input data to the technical analysis and to verify the solutions from a technical, economical and logistics perspective. See Figure 2-1 for a broad overview of the INNOTRACK work plan structure.

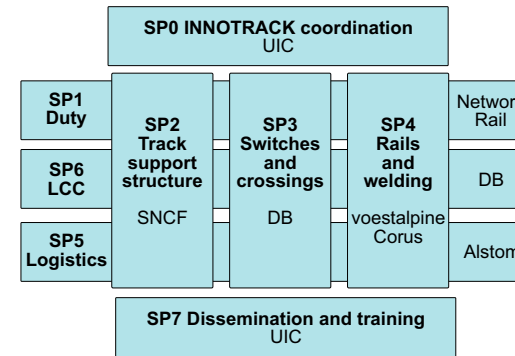

Figure 2-1 The INNOTRACK project organisation. The sub-projects are indicated with their responsible partners.

The three technical (vertical) sub-projects are.

- **Track support structure** (denoted SP2 in the project)

The sub-project has studied track subgrade monitoring and assessment. Furthermore, evaluation and test of superstructure innovations have been carried out.

- **Switches and crossings** (denoted SP3 in the project)

The sub-project has studied optimized switch designs where predictive modelling has played a key role. Further standardisation of driving and locking devices, and also the development of switch monitoring equipment have been key elements.

- **Rails and welding** (denoted SP4 in the project)

The sub-project has dealt with methodologies to establish rail deterioration under varying operational conditions. It has established maintenance criteria and methodologies. It has further studied improved methods for test of rail materials, for rail inspection and for welding.

These sub-projects could be described as traditional technical projects. They are supported by three cross-disciplinary (horizontal) sub-projects:

- **Duty and requirements** (denoted SP1 in the project)

The aim of this subproject was first to identify current problems and cost drivers for the existing infrastructure. After the root causes had been identified, the project would propose innovative solutions in order to mitigate the problems. In the end of the project a technical verification of technical solutions that had not been validated in the technical sub-projects was carried out. The aim was to deliver innovative solutions that were both technically and economically verified (see “Life cycle cost assessment” below). Since the validation should comprise operational conditions from all over Europe, variations in vehicle and track characteristics had to be carefully investigated. Finally, this sub-project also had the responsibility to assess the overall potential cost reduction derived from the INNOTRACK solutions.

- **Life cycle cost assessment** (denoted SP6 in the project)

There were two ideas with this subproject. The first was to economically verify the innovative solutions to the technical problems. This was carried out with LCC and RAMS analyses. The second was to an Europe-wide accepted evaluation/development process.

- **Logistics** (denoted SP5 in the project)

Here the potential for logistic improvements were identified and proposals for promising areas of improvement brought forward. Furthermore, the sub-project was responsible for a logistics assessment of derived technical solutions. Logistics should here be understood in a broad sense that incorporates aspects such as sourcing and contracting.

### Supporting activities

In order to make dissemination, training and implementation more efficient, it was already from the beginning decided that UIC with the support of UNIFE should coordinate these activities in INNOTRACK. The activities were collected in a separate sub-project (denoted SP7 in the project). It was particularly important that the results from INNOTRACK really were implemented and not only resulted in “shelf warmers”. The experience from previous projects from several participants was clear: Organisations with experience of dissemination must play a central role to assure a successful implementation.

Finally, a sub-project was dealing with the overall coordination and management of INNOTRACK (denoted SP0), see more details in the section “Management and organisation”.

### INNOTRACK’s role in the railway sector

A second important reason for INNOTRACK is that there exist a large number of codes and standards in the area of track and substructures that are based on empiric knowledge. These answer the question “how” but not the question “why”. However, when the new demands mentioned above are to be met, the current “how” is not valid anymore since the operational conditions change. In such situations there is a need to really understand “why” so that changes in operational conditions can be met and handled in a safe and cost efficient manner. This is further emphasized by the known fact that the railway system is very sensitive to changes. Even minor modifications can result in considerable deterioration of the railway system. Consequently, changes to the railway system have to be introduced with accuracy and modifications be kept within acceptable limits (which in turn have to be established). Consequently, there is a need for a pre-verification of technical solutions that are to be operationally introduced.

What does a *verification* of the solutions imply? The IM’s have the responsibility for the railway system. This means that it is the performance of the *whole* system that is the priority for the IM’s. The industry delivers products that must fit into this system so that the *overall* performance is kept or enhanced. Since the system is very complex, projects like INNOTRACK are important as they enable a comprehensive cooperation between IM’s and the industry regarding the *entire* track construction. This need for co-operation is necessary for all partners and is further discussed in chapter 11.

The need for verification is seemingly in contrast to the need to reduce time to market for innovative solutions. However, through a better knowledge of “why”, there is a major potential in actually decreasing time needed for verification. Furthermore, the mode of operation adopted in INNOTRACK where IM’s, industry and research organisations work in close co-operations lead to solutions that are verified already in the design phase. This leads to an additional decrease in time-to-market. However, when it comes to the issue of legal and operational procedures for verification and approval, it was realised that this is an extensive question, which ranges outside the scope of INNOTRACK. This issue has therefore been handed over to suitable bodies for further work.

EU-funded R&D projects are limited in time and often very focused on implementation. For this and other reasons it is difficult to carry out basic R&D within EU-projects. Input from ongoing or recently ended projects is therefore important in projects such as INNOTRACK. Consequently, the choice of participating organisations has been very important. It was for this reason also important that the universities and research institutes that participated engaged senior researchers.

Finally, if innovative solutions are to be implemented it is vital to assure a good quality. For this reason a considerable amount of reviewing has been carried out in INNOTRACK. In fact several external

experts were contacted already before the project started. Details on the review process are given in chapter 10 where the review process is described. Here it is sufficient to note that, in addition to increasing the quality, the reviewing has also facilitated implementation. The reason is that much reviewing has been carried out by IM’s outside of INNOTRACK. In reviewing the reports they have gained knowledge of the INNOTRACK results and been able to estimate the benefits of implementation at their railways.

### INNOTRACK and the current regulatory framework

In theory, the hierarchy of the regulatory framework in Europe can be described as a pyramid, see Figure 2-2. This is described more in detail in deliverable D7.1.5 [1].

The top level consists of directives. These are usually of very good quality. The second level includes the legal specifications. For the railways the most important are the Technical Specifications for Interoperability (TSI). The third level consists of codes, norms and standards. Here CEN codes are dominating. It should be noted that the levels 1 to 3 exist also on a national level. The amount of harmonization between national and European regulations varies between countries, both in terms of how much of the European framework that is fully adopted and in the amount of additional national regulations. Also the organisation of authorities

responsible for this regulatory framework differs between countries. This makes it difficult to make general remarks on the interaction with the work in INNOTRACK.

At levels 4 to 7 the situation is still more diffuse and the actual situation may vary even more between countries. In Figure 2-2 we have tried to include some typical levels in order to explain the clear intention in INNOTRACK to place the result as high up as possible in the hierarchy. The reason is simple: the higher up in the hierarchy the results are introduced, the easier they are to implement Europe-wide.

In our categorization, level 4 consists of leaflets and equivalent documents. The leaflets (where UIC leaflets is the typical example) represent the common opinion of several organisations (typically infrastructure managers). A lot of the results from INNOTRACK will be employed as background material to update current leaflets.

Level 5 consists of guidelines. These are a way to express more precise statements on recommendations for implementation than ordinary reports. They are in this sense generally more “hands-on” than leaflets. In INNOTRACK it has been a clear ambition to place several deliverables at this level. To this end, several selected INNOTRACK reports have been classified as “INNOTRACK guidelines”.

Level 6 consists of reports from research, development and investigations and level 7 consists of state-of-the-art and research reports. Most of the results from INNOTRACK are initially positioned at this

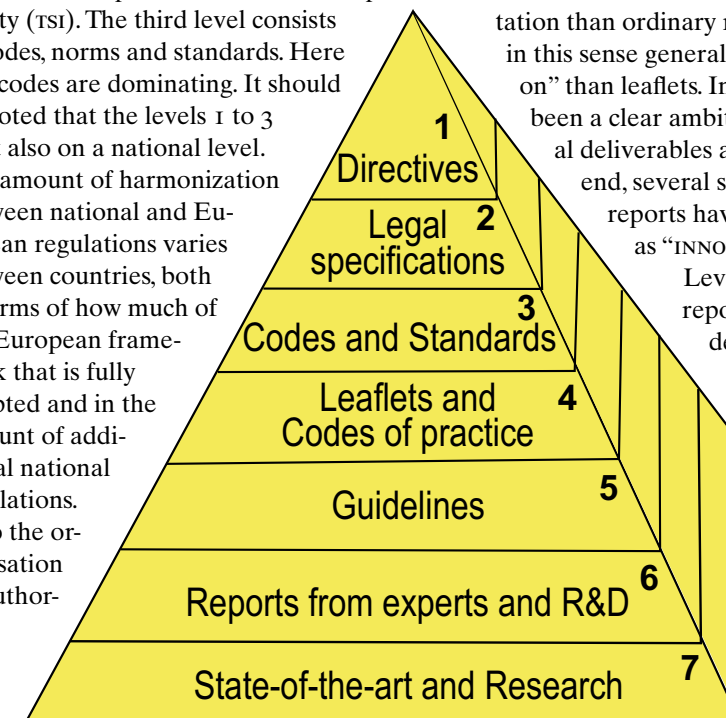

Figure 2-2 Theoretical hierarchy of regulations in the European rail sector

level. Here it is important that the results are well documented and maintained so that future R&D and work of creating regulatory documents at a higher level can benefit from the work done.

Note that the higher up you are in the pyramid, the more time it has generally taken to establish the regulatory documents. The significant time it takes to produce a standard or a TSI (in the order of a decade from initiation to final code/specification) means that a considerable amount of the content is old and out of date. If this is not mitigated, the railways will not benefit from R&D in an efficient way. INNOTRACK has been trying to help in this aspect by a rapid communication of research results to the regulatory bodies through its established dissemination platform.

A more detailed description, and also an overview of some current regulations and practices is given in D7.1.(1). From this description, it is obvious both how complex the current regulatory situation is and the amount of work which remains before harmonisation of standards is a reality in Europe.

### Objectives

The main objective of INNOTRACK can be expressed in one sentence:

Increase the competitiveness of the railway sector by decreasing track related life cycle costs.

Within this overall scope there are of course additional requirements: Safety must not be compromised, environmental issues (mainly noise pollution) need to be dealt with, and the performance, efficiency, reliability, availability and maintainability of the railway has to be improved.

These objectives have been addressed by the EC White Paper on transport (September 2002). This report sets ambitious targets for railway operations that include:

- Double amount of passenger traffic and triple amount of freight traffic by 2020

- Improved travel times by 25% – 50%
- Reducing life cycle cost by 30%
- Reducing noise to 69 dB for freight and 83 dB for high speed rails
- Increasing safety – reduce fatalities by 75%

The Railway Business Scenario 2020 also requires that:

- Railways capture 15% of the freight and 12% of the passenger market

These objectives can only be met by increased R&D and standardisation at a European level!

The railway vehicle industry has already responded to the new challenges set before it, and will continue to respond by implementing:

- Increased speed and acceleration
- Increased axle loads and traction power
- More rigid vehicles with greater running gear stiffness

These innovations however have a downside: they place greater demands on the track, causing more damage and higher maintenance costs. A main challenge of INNOTRACK was to address these altered operational conditions.

The second major objective of INNOTRACK that has also been discussed above is to streamline the introduction of innovative solutions: Railways have suffered for too long from innovative technologies that turn out to be too ambitious and expensive to maintain. At one of the latest World Congress of Rail Research, it was claimed that two-thirds of all railway research is undertaken by the supply industry. This leads to significant innovation in products and services offered by the industry. However, to assure that the innovative solutions do indeed bring benefit to both industry and IM's two issues need to be tackled:

- The time to market and acceptance by IM's needs to be significantly reduced to justify the continued investment in R&D by the supply industry.

- Innovative solutions have to be verified from a railway system perspective.

If these challenges are not met, the railway sector will face technological stagnation and eventually lose ground to other means of transportation.

As mentioned above, INNOTRACK has responded to these needs in several ways:

- The increased level of knowledge gives the potential for a more focused verification, which will decrease the time needed
- The close cooperation in INNOTRACK between IM's, industry, and research organisations has resulted in already verified (fully or partially) technical solutions. The verification comprises both technical and economical aspects. This leads to an additional decrease in time-to-market.
- Issues regarding legal and operational procedures for verification and approval, have been identified and handed over to suitable bodies for further work.

As an overall measurable objective, INNOTRACK aims at a 30% LCC reduction of track-related costs. To quantify the benefit of developed solutions INNOTRACK has developed a harmonised method for LCC calculations. This harmonised model also facilitates LCC comparisons on a European wide basis.

Regarding the objectives of INNOTRACK, it should finally be noted that INNOTRACK has provided a unique opportunity to bring together all major stakeholders – manufacturing and contractors; supply industry; infrastructure managers; railway undertakings; system integrators, and the elite of the European railway research community. During the course of INNOTRACK it has been possible to have a concentrated focus by all these parties on identified common European cost drivers. The outcome of these concentrated efforts, as manifested in INNOTRACK'S OVER 140 R&D reports, will shape the development of the railway track sector of Europe for a long time.

### Management and organisation

The INNOTRACK consortium was comprised of 36 partners. This high number of organisations was necessary due to the need for the multi-disciplinary expertise that was required for the project. Further, the partners comprised infrastructure managers, railway industry suppliers and research bodies spread over Europe.

Integration aspects were thus the key for the success of INNOTRACK. To this end, the management structure had to be adapted to the specific project context. The starting point for the INNOTRACK management structure came from the experience of previous large R&D projects: Both the lessons learnt and the successful methods and tools from these projects have been exploited in INNOTRACK.

The overall project management structure has been discussed above. A more detailed picture is given in detail at the next page in, Figure 2-3.

### Deliverables and responsible partners

In simplistic terms one can say that the INNOTRACK organisation sets out from the expected results of INNOTRACK: the deliverables.

All results are reported in the form of deliverables, i.e. reports that describe the results (which can be installed ground reinforcements, gained knowledge, populated databases etc). To ensure a strict responsibility for each deliverable, a responsible partner (i.e. organisation) was assigned. Further, a responsible person in this organisation was identified. This person was responsible for quality assurance of the report and for delivering the report on time.

### Work packages (WP) and work package leaders

The tasks carried out in INNOTRACK were already in the preparation of the project clustered into work packages. These contained well-defined areas of R&D. Each work package had an assigned work package leader (organisation) and a person responsible

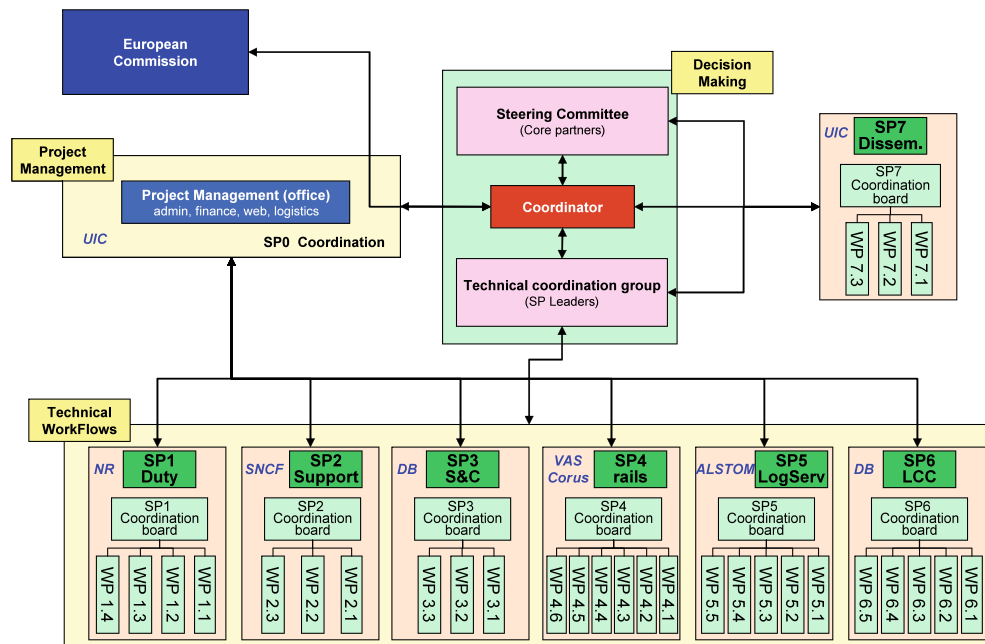

Figure 2.3 Management Structure

for coordinating the work. This included supervising the preparation of deliverables in the WP and maintaining good communication between the WP partners. To give an idea of the size of a WP it can be noted that the number of deliverables produced in an INNOTRACK WP ranged from 2 to 16.

#### Sub-projects (SP) and sub-project leaders

The responsibilities of the sub-projects were to coordinate the work packages in a scientific/technical area and to maintain good communication within the SP and with the project manager. Each sub-project had an assigned SP-leader and one (or several) assigned person(s) responsible for the operational work. The number of deliverables in an SP varied between 13 and 32.

The mode of operation in general, and the organisation of meetings in particular were kept very informal within INNOTRACK. Smaller SPs often had meetings encompassing the entire SP, whereas larger SPs mainly had WP meetings and occasionally meetings between the WP-leaders and the SP-leader(s).

#### The technical coordination group (CG)

The two main motivations for the coordination group were to coordinate R&D at a project scale and to prepare upcoming questions to be approved by the steering committee. The technical coordination group consisted of the SP-leaders, the project manager (chair), representative(s) from the project office and the scientific/technical coordinator.

The coordination group has met four times a year with extra meeting during the last year. The coordination group has focused on the progress of the technical work. This included supervision of the preparation of deliverables, proposal of changes to the project programme (including allocation of funding), and integration and coordination between the different sub-projects. The latter was especially important between the horizontal and the vertical SPs.

#### The steering committee (SC)

The steering committee had a strategic role that included deciding upon allocation of project budget and major changes in sub-

projects and work packages. It was composed of the representatives of ten core partners, namely: UIC, UNIFE, Alstom, Banverket, Balfour Beatty Rail, Corus, Deutsche Bahn, Network Rail, voestalpine, Réseau Ferré de France. In addition, the project manager and representative(s) from the project office have been present at the steering committee meetings. These were held three times a year during the two first years and four times during the last year. The preparation of the items to be handled during the steering committee meetings was made by the project manager.

The steering committee was continuously informed of the progress of INNOTRACK and all major questions were brought up and handled by the steering committee. The role, responsibility and decision power of the steering committee was clearly formalised in the INNOTRACK consortium agreement.

A strong steering committee was a necessity for a project as large and with as many partners as INNOTRACK. The work in the steering committee has run smoothly with a clear aim and direction to support INNOTRACK. Decisions were taken based on consensus in all cases except one where voting was applied.

#### The project manager (PM)

The project manager has been responsible for all aspects of the interface between the project and the EC. Through the coordination group the project manager has ensured that the progress of INNOTRACK has followed plans in terms of the project schedule and objectives; and further that the quality of the deliverables has been high. To this end, the project manager chaired the coordination group.

The project manager has also ensured that questions like reallocation of resources and under performing participants have been handled and that decided actions were formally correct and swift. Here the steering committee played an important role.

The project manager has also maintained regular contacts with other European organisations like CEN, EIM, CER, etc.

The project manager has also ensured that scientific, industry and railway review

was carried out by assuring sufficient resources and contacts.

#### The project office

The project office has been staffed by the project manager and a project team. The project manager and project team have handled the daily management work and project logistics. All pertinent information has been placed on the UIC website, which all project partners have had access to.

The project office has continuously prepared material for the steering committee and coordination group meetings to provide a basis for productive meetings. The project office has also handled all overall economical questions in INNOTRACK.

Due to the dimension and complexity of INNOTRACK the management has been led by ARTIC, an experienced SME specialised in the management of large complex international R&D projects.

#### The scientific/technical coordinator

The scientific/technical coordinator of INNOTRACK had the role of assuring the quality of the produced deliverables. This was mainly carried out through peer reviewing at three levels:

1. Internal reviewing during the drafting of the deliverable report
2. Internal reviewing by an independent project partner
3. External reviewing

Here, the scientific/technical coordinator was responsible for the last two levels. Operationally, the external scientific and railway reviewing has been organized directly by the scientific/technical coordinator. The industrial review was carried out through UNIFE. The outcome and impact of the reviewing is described in detail in chapter 10.

It was also the responsibility of the scientific/technical coordinator to inform the project manager, the SP-leaders and the EC officer on the deliverable status including the status of the reviewing.



#### **Coordination of dissemination and training**

Dissemination and training have been considered especially important in INNOTRACK. The coordination of dissemination and training has been managed by UIC and UNIFE through their natural network of contacts.

The training activities have mainly been managed through UIC where there are established groups for such activities. The

main exception was the targeted training on LCC analysis that was organised and carried out by DB.

#### **References**

1. INNOTRACK Deliverable D7:1.5, Identification of relevant codes and correlation to innotrack results, 22 p, 2009

## **COST DRIVERS AND HOW THEY ARE ADRESSED IN INNOTRACK**

# **3**

# COST DRIVERS AND HOW THEY ARE ADDRESSED IN INNOTRACK

John Amore, Network Rail; Anders Ekberg, Chalmers; Jay Jaiswal, Corus  
More information is available in Deliverables D1.4.6 and D1.3.3

The cost of track maintenance and renewal is a major constraint on the increased use of rail for both passenger and rail traffic. The railway industry has traditionally used classic methods for reducing costs such as “right first time”, “lean maintenance”, optimisation of possessions and high output machines. Generally the savings achieved through these approaches reduce through each new initiative as waste is driven out of the system, but in many cases customer costs for rail transport nevertheless continue to rise in comparison with road transport.

The INNOTRACK project seeks to create a step change in cost reduction for track maintenance and renewal by the introduction of new products and processes that have a longer life or lower process cost than present systems.

The first question to address is whether there is a general case for the European railway system, or if the railways of Europe significantly differ due to historic reasons of construction, development, standards and maintenance practices. Significant differences between the technical cost drivers would require to investigate the reasons by modelling typical vehicles and track characteristics of the railways experiencing the differing problems.

If the principle technical cost drivers for track maintenance and renewal for the participating Infrastructure Managers (IM’s) could be matched, excluding differences due to geographic location, the INNOTRACK innovation should work on general cases with reasonable confidence

that the solutions are generally applicable to the INNOTRACK partners.

The first step in the process of understanding whether we should consider the technical cost drivers as a single system and where the greatest opportunity for cost reduction could be achieved required knowledge of

- What are considered to be the chief cost drivers for each participating country
- What proportion of total cost do these cost drivers represent
- How do these costs compare with other participating IM’s

These questions were addressed at a series of national workshops attended by track engineers and others with specialist knowledge relating to the technical cost drivers. The process is reported in the deliverable D1.4.6 *A report providing detailed analysis of the key railway infrastructure problems and recommendation as to how appropriate existing cost categories are for future data collection*

The main track problems based on the frequency with which they were reported by INNOTRACK partner IM’s, and listed in order of importance, were:

- Track: bad track geometry
- Rail: cracks and fatigue (the term crack is here used in a broad sense)
- Switches and crossings (s&c): switch wear
- Substructure: unstable ground
- Joints: insulating block joint failure
- Rail: corrugation
- Rail: wear

- Structures: major line closures
- Fasteners: worn/missing pads
- Sleepers: renewal optimisation
- Culverts/pipes: flooding
- Ballast: stone spray on passing axles
- Ballast: ballast wear
- Rail: low friction/adhesion
- Joints: weld quality
- s&c: common crossings
- s&c: manganese crossings
- s&c: geometry maintenance
- s&c: loss of detection

The study has shown that there is a positive correlation between the importance of a track problem as assessed by the frequency of reporting and as assessed by cost impact. Most significantly for the INNOTRACK application of new products and processes there is strong similarity in technical cost drivers for the participating IM’s once the cost implications of severe winter conditions are eliminated.

Once the most significant cost drivers have been established from the national workshops, the next step was to investigate what was known, about the root causes of the conditions responsible for the identified cost drivers. Once root causes are known innovation should be targeted at eliminating or mitigating these, whichever has the lowest LCC. Deliverable D1.3.3 *Final report on root causes of problem conditions and priorities for innovation* explained in detail the root causes of the problem conditions and suggested some priorities for innovation without being specific regarding the nature.

The following sections give an overview of the investigation of root causes and priorities for innovation as outlined in deliverable D1.3.3 *Final report on root causes of problem conditions and priorities for innovation*. It further gives details on how the priorities have been addressed in INNOTRACK.

The ten most important track problems and their underlying causes, identified by IM’s on the basis of their cost impact, were:

TRACK PROBLEMS	POTENTIAL CAUSES
Rail: cracks and fatigue	creep forces, stresses that exceed the material strength
Rail: cracks and fatigue	bad wheel/rail interface
Track: bad track geometry	soft sub-structure/bad drainage
S&C: wear in switches	sub-structure
Rail: corrugations	vehicle/track interaction
S&C: cracked manganese crossings	weld quality, lack of grinding maintenance, porosity, high impact loads
S&C: geometry maintenance	unknown optimal maintenance regime
Sub-structure: unstable	soft sub-structure/wet bed
Track: bad track geometry	sub-optimal maintenance
Track: bad track geometry	wrong/unknown stress free temperature

## 3.1 Rail: Cracks and fatigue

### Causes

Main causes for rail cracks and fatigue include rolling contact fatigue (RCF) mechanisms as detailed below, initiation at corrosion spots, welded joints (see section 3.8), stress concentrations at machined holes and other notches, and misaligned rail joints.

Rolling contact fatigue (RCF) cracks on the rail can be classified into those that are subsurface-initiated and surface-initiated. Subsurface-initiated cracks are normally a consequence of high vertical loading in combination with any micro-structural features that represent a critical defect size to initiate fatigue. On the other hand, most surface initiated cracks are the result of tangential wheel–rail interaction. A more specific division can be made into shelling, head checks, taches ovale, and squats etc (see UIC leaflet 712).

When the crack length reaches a critical value the crack may turn down into the rail, giving rise to transverse fracture of the rail.

The mechanisms of wear are similar to those leading to surface crack initiation. There is a continuous interaction between the two mechanisms. As the wear rate increases some of the material in which RCF has initiated is worn off, reducing the rate of RCF initiation.

### Priorities for innovation

1. Wheel and rail profiles to minimise energy generated in the contact patch
2. Friction management
3. Rail steels with increased resistance to RCF and wear
4. Methods for absorbing or damping energy away from the wheel–rail interface
5. High speed rail re-profiling systems
6. Monitoring systems

### How INNOTRACK has addressed these priorities

1. Maintaining wheel and rail profiles through grinding has been thoroughly studied. The study is reported in deliverables D4.5.1 *Overview of existing rail grinding strategies and new and optimised approaches for Europe*, D4.5.2 *Target Profiles*, D4.5.3 *Input for LCC-calculations*, and the guideline D4.5.5 *Concluding grinding recommendations*. The latter focuses on how to introduce a shift from rectification to preventive cyclic grinding. It deals also with aspects such as logistics and allowable tolerances.
2. Friction management and lubrication studies were originally not included in the work programme. However, studies on rail–wheel profile management necessitated consideration of this area. Hence, friction management practices throughout Europe have been discussed in deliverable D4.5.4 *Friction management methods*. Potential for improvements have been pointed out. It was concluded that the benefits arising from friction management practices have to be evaluated in field trials. Such trials would require at least five years, which is significantly beyond the timescale of the INNOTRACK project.
3. The issue of rail steels with increased resistance to RCF and wear has been thoroughly investigated in deliverables D4.1.2 *Interim rail degradation algorithms*, D4.1.3 *Interim guidelines on the selection of rail grades*, D4.1.4 *Rail degradation algorithms*. The conclusions have been compiled in the guideline D4.1.5 *Definitive guidelines on the use of different rail grades*. This guideline is intended as a basis for an update of the UIC leaflet 721 and is a focus in the dissemination programme. In particular

practical observations in track and in controlled laboratory tests show that the resistance to both wear and initiation of rolling contact fatigue cracks increases with increasing hardness of the rail.

4. Methods for absorbing or damping energy away from the wheel rail interface have not been explicitly addressed. However, work has been carried out on the overall resilience of the track systems, see e.g. chapter 4 on track support, and also the work that has been done on support of switches and crossings, see chapter 6.
5. High-speed rail re-profiling systems have not been explicitly addressed. Optimisation of logistics to improve productivity of grinding has been discussed in the guideline D4.5.5 *Guidelines for management of rail grinding*.
6. Various monitoring systems have been investigated and tested. The investigation is reported in the deliverables D4.4.1 *Assessment of rail inspection technologies in terms of industrial ripeness*, D4.4.2 *Operational evaluation of a multifunctional inspection equipment (phase 1 : laboratory and static tests)*, and D4.4.3 *Operational evaluation of a multifunctional inspection equipment (phase 2 : track tests)*.

In addition to these studies, INNOTRACK has also carried out extensive investigations on “minimum actions”. These are the minimum efforts in form of inspections, maintenance and repair that can be allowed if the rail is going to be operated in a safe, reliable and efficient manner. The studies include rail breaks due to initiation at corrosion spots in the rail foot and head checks in the railhead, squats and corrugation. Also the deterioration of insulated joints, including the effect of misaligned rail joints, has been thoroughly

investigated. The details are available in deliverables D4.2.1 *Estimations of the influence of rail/joint degradation on operational loads and subsequent deterioration. Tentative report*, D4.2.2 *Interim report on “Minimum Action” rules for selected defect types*, D4.2.3 *Improved model for loading and subsequent deterioration of insulated joints*, D4.2.4 *Improved model for loading and subsequent deterioration due to squats and corrugation*, D4.2.5 *Improved model for the influence of vehicle conditions (wheel flats, speed, axle load) on the loading and subsequent deterioration of rails*. The recommendations are compiled in the guideline D4.2.6 *Recommendation of, and scientific basis for minimum action rules and maintenance limits*.

Further, investigations have been carried out on rail testing and characterisation of the deformed microstructure as an objective assessment of rail damage. This will benefit the predictive capabilities regarding rail performance under different operational conditions. The investigations are summarized in deliverables D4.3.7 *Innovative laboratory tests for rail steels – Final report*, and D4.3.8 *Guideline for laboratory tests of rail steels*.

See chapter 5 for a more extensive description of these studies.

## 3.2 Track geometry: Poor track support and suboptimal maintenance

### Causes

Bad track geometry includes the following conditions:

- Poor vertical profile and cross-level often related to poor ballast and/or formation.
- Poor gauge and alignment that often occurs in curves or transitions when track does not possess adequate gauge strength or panel shift strength.

Excessive vertical and lateral wheel/rail forces or poor installation and maintenance including inadequate drainage are other possible causes of track geometry degradation. There is strong evidence that where the installed track quality is good, it will take longer to degrade due to reduced energy input into the track system by rail traffic.

For many IM's, rectification of poor track geometry is one of the highest track maintenance costs, including acquisition and analysis of track recording car data, tamping, ballast cleaning and replacing ballast.

However, these activities are designed to reinstate the track quality to the original condition. If there are no other changes to the system, the track quality will degrade as before. Increasing traffic, higher axle loads or speed will result in an increased rate of degradation.

There are a number of methods currently used to reduce track degradation rates including under sleeper pads designed to reduce the sleeper/ballast contact stresses and the energy transmitted into the ballast and subgrade. Where poor subgrade is known to contribute to high track degradation rates there are a number of subgrade reinforcement techniques available. The study reported in deliverable D2.2.1 *State of the art report on soil improvement methods and experience* describes twentyfive subgrade enhancement methods. There is

clearly a need to develop a toolset that will assist the maintenance teams to select the improvement technique offering the lowest LCC solution for a specific site. This has been targeted e.g. in the guidelines D2.2.6 *Guideline for subgrade reinforcement with geosynthetics Part 1: enhancement of track using under-ballast geosynthetics Part 2: Improvement study of transition zone on conventional line* and D2.2.8 *Guidelines for subgrade reinforcement with columns. Part 1; vertical columns and Part 2; inclined columns*.

### Priorities for innovation

Reduction in the cost of track maintenance must begin with addressing the high cost of periodically reinstating the track quality. Other measures such as the introduction of high strength steel rails or advanced grinding strategies will be largely negated if the track quality is not maintained at a high level.

Suggested methods to eliminate or reduce the cost of bad track geometry are:

1. A ballastless track design with low LCC
2. Novel sleeper or ladder track designs to reduce the stress on track support
3. Improved designs for energy absorbing devices that are tuned for the traffic and track characteristics, or may be used in combination with novel sleeper designs
4. Self adjusting rail support that maintains track quality to a limited degree
5. Improved design and installation to minimize the influence of track transitions
6. Elastic fastening systems to maintain adequate gauge strength
7. Methods and designs to improve panel shift strength

### How INNTRACK has addressed these priorities

1. Two ballastless track solutions have been developed and LCC assessed. Details are available in deliverables D2.3.2 *Optimised design of steel-concrete-steel track form*, D2.3 *Design and manufacture of embedded slab track components*, D2.3.4 *Testing of the innovative BB ERS trackform*, and the guideline D2.3.5 *A novel two-layer steel-concrete trackform for low maintenance S&C*.
2. Novel sleeper or ladder track designs have not been addressed in INNTRACK. However an LCC assessment of ladder track designs has been carried out.
3. Improved designs for energy absorbing devices has to some extent been assessed in the studies of subsoil reinforcement, see chapter 4. See also chapter 6 on the improvement of vertical stiffness in switches and crossings.
4. Self-adjusting rail supports have not been investigated.
5. Track transitions have been studied both regarding plain track (see deliverables D2.1.10 *Study of variation of the vertical stiffness in transition zone* and D2.2.7 *Substructure improvement of a transition zone on a conventional rail line* and in switches & crossings, see D3.1.5 *Recommendation of, and scientific basis for, optimization of switches & crossings – part 1*, and D3.1.11 *Results of continuous RSMV stiffness measurements on switches at DB*.
6. Fastening systems have not been evaluated in INNTRACK.
7. Panel shift strength has not been explicitly investigated in INNTRACK. However it is part of the general studies on track reinforcements, see chapter 4.

In addition to this, the work in INNTRACK includes extensive studies on investigation and assessment of subsoil strength and on track reinforcement. See section 3.3 and chapter 4.

## 3.3 Substructure: Unstable ground

### Causes

Unstable ground may relate to the geotechnical nature of the location, or the method of construction used at the site.

When track substructure is defined as ballast, sub-ballast and formation, causes of unstable ground can relate to any of these layers. Very often, unstable ground is also associated with poor drainage.

In the ballast layer, fouled ballast is often the culprit. Fouled ballast has very high stiffness and little damping, and therefore is not capable of accommodating high wheel/rail forces, which eventually results in poor track geometry.

Due to poor drainage the ballast layer can become weak, deforming excessively. This leads to poor track geometry, which in turn causes higher wheel/rail forces.

A saturated sub-ballast layer (a layer between ballast and formation) due to fouling materials and poor drainage can lose its strength under repeated dynamic wheel loads, thus becoming an unstable layer.

If formation is built with soft or marginal soils, it can become unstable either in a progressive manner or suddenly. Sudden formation failure rarely occurs, unless there is a dramatic change of environment (such as high rainfall and flooding) or load conditions (such as a large increase of wheel loads). Progressive deformation (shear), however, often occurs for formations built with soft or marginal soil types. This progressive deformation can become rapid, leading to rapid track geometry degradation when speed or axle load increase, because the bearing capacity of formation soil may not be sufficient to withstand the stresses caused by traffic loads. In addition, poor drainage or ingress of water to the formation may reduce soil strength, leading to excessive deformation or unstable ground.

Established techniques for correcting unstable ground include:

1. Geogrids that can improve bearing capacity of formation
2. Short piling, geo(stone) piers or lime-cement pillars installed under the ballast layer to improve bearing capacity of formation
3. Ballast undercutting and shoulder cleaning to improve ballast drainage
4. Stone blowing or design lift tamping to improve ballast deformation characteristics
5. Sufficient ballast layer thickness with good quality ballast materials to reduce stresses transmitted to the formation
6. Adequate sub-ballast layer (formation protection layer)
7. Removal and replacement of poor formation soil
8. Hot mix asphalt underlay (between ballast and formation) to reduce stresses transmitted to the formation and to prevent surface water penetration into the formation

### Priorities for innovation

1. Novel substructure improvement techniques with low LCC
2. Geotechnical practices that can improve track drainage
3. Production use of latest track substructure inspection technologies such as track modulus testing and GPR (ground penetrating radar) testing as an aid to identifying the nature of problem sites

### How INNOTRACK has addressed these priorities

1. This has been extensively investigated in INNOTRACK. The investigation (with pertinent LCC evaluations) includes:

- a. Piling with short columns and inclined lime cement columns. Both are innovative techniques that remove the necessity of dismantling the track. See deliverable D2.2.5 *Subgrade reinforcement with columns Part 1: vertical columns Part 2: inclined columns*, and the guideline D2.2.8 *Guideline for subgrade reinforcement with columns. Part 1; vertical columns and Part 2; inclined columns*.
  - b. Geogrids. Experimental testing has been employed to improve the knowledge of reinforcement capability and mechanisms. Together with numerical simulations this facilitates an optimization of reinforcements. Full-scale tests have also been carried out with the aim of reinforcing the track at transition zones and at locations with poor drainage. Details can be found in deliverables D2.2.7 *Substructure improvement of a transition zone on a conventional rail line*, and D2.2.9 *Subgrade reinforcement with geosynthetics*.
2. Geotechnical practices that can improve track drainage have to some degree been investigated in D2.2.9 *Subgrade reinforcement with geosynthetics*.
  3. Substructure inspection technologies have been extensively charted, improved and validated. Details may be found in deliverables D2.1.2 *Adapted Portancemeter for track structure stiffness measurement on existing tracks*, D2.1.6 *RSMV stiffness measurements*, D2.1.7 *Investigation with PANDA/geo-endoscopy – Results and analysis of measurements*, D2.1.9 *Adapted Portancemeter for track structure stiffness measurement of existing track meter*, D2.1.10 *Study of variation of the vertical stiffness in transition zone*, D2.1.13

*Stiffness data processing and evaluation*, D2.1.15 *Non-destructive geophysical methods*, and are summarized in the guidelines D2.1.5 *Methodology of geophysical investigation of track defects*, and D2.1.11 *Methods of track stiffness measurement*.

In addition, significant efforts have been made in INNOTRACK to translate the measured characteristics to operational capabilities through numerical simulations. Details are found in deliverable D2.1.3 *First phase report on the modelling of poor quality sites*, and D2.1.16 *Final report on the modelling of poor quality sites*, and in the guideline D2.1.12 *Modelling of the track subgrade Part 1: Final report on the modelling of poor quality sites Part 2: Variability accounting in numerical modelling of the track subgrade*.

Furthermore, all measurement data have been compiled in a database with a developed interface that makes it readily accessible from a web browser. Details are found in deliverables D2.1.1 *In-situ measurement preliminary database, based on information management framework*, D2.1.8 *In-situ measurement database, based on information management framework*, and D2.1.14 *Concluding update of D2.1.8*. Examples of use of the data can be found in the deliverable D2.1.4 *Report on sampling and analysis of geotechnical test results*.

## 3.4 S&C: Switch wear, plastic deformation and cracking

### Causes

A switch forms a discontinuity in the track. It is a discontinuity with regards to track support due to the altered sleeper dimensions and arrangement. During tamping operations this may also require a separate operation or manual correction. A switch also forms a discontinuity for the wheel rail contact patch that may give rise to high transient vertical and creep forces. High lateral forces from vehicles in diverging routes will also add to the deterioration.

A switch will experience higher forces than plain line and the life of the switch will generally be reduced by plastic deformations, wear and/or fatigue cracks. The installation and maintenance of a switch is critical to its performance. An error may not be immediately apparent.

### Priorities for innovation

The present design of rail vehicles where stability at higher speeds is considered more important than a design for minimum track damage and low angles of attack makes the design of a highly reliable long life switch increasingly difficult. Areas for innovation that should reduce the LCC and improve RAMS for switches include:

1. Novel designs of switch reducing wheel–rail forces to the minimum possible and using advanced materials to reduce wear and crack initiation.
2. When properly used, established vehicle dynamics models have proven to be extremely useful for evaluating proposed turnout geometries. However, the model output accuracy is dependant on input data, including wheel and rail profiles, vehicle suspension characteristics and track and rail stiffness parameters. The development of modelling guidelines to be applied specifically for analysis of s&c designs is worth consideration.

3. Revised switch point and closure curve geometry that encourage axle and bogie steering to reduce wheel–rail forces.
4. Improved frog design to reduce wheel–rail impact forces.
5. Easily replaceable components where wear and cracking occurs.
6. Switches designed for automated maintenance methods, specifically but not only the use of hollow steel bearers to house operating and lock rods and over-the-bearer stretcher bar designs.

### How INNOTRACK has addressed these priorities

1. Novel designs have been a major focus in the INNOTRACK research. The innovative solutions include gauge widening, tuned support and optimized component geometries. The investigation also includes the influence of novel s&c materials and field studies are on-going. Details are available in the deliverable D3.1.1 *Definition of key parameters and constraints in optimisation of s&c*, and D3.1.3 *Draft specification of the s&c demonstrators*, and in the guidelines D3.1.5 *Recommendation of, and scientific basis for, optimization of switches & crossings – part 1*, and D3.1.6 *Recommendation of, and scientific basis for, optimization of switches & crossings – part 2*.
2. The first part of the study in INNOTRACK was a benchmark of different vehicle–track interaction models. This identified capabilities and limitations of the different numerical codes and models used. It also highlighted capabilities and limitations in the field measurements. Details are available in deliverable D3.1.4 *Summary of results from simulations and optimisation of switches*. The continued work in INNOTRACK included a pioneering effort of predicting plastic deformation

and wear through a coupled vehicle dynamics – elasto-plastic finite element simulation. The predictions have been validated towards field measurements under operational conditions.

3. Optimized switch point and closure curve geometries have been developed. Details are available in D3.1.5 *Recommendation of, and scientific basis for, optimization of switches & crossings – part 1*. The optimized geometries are currently evaluated in full-scale tests.
4. Optimized frog geometries have been developed. Details are available in D3.1.5 *Recommendation of, and scientific basis for, optimization of switches & crossings – part 1*, and D3.1.6 *Recommendation of, and scientific basis for, optimization of switches & crossings – part 2*. The innovative frog designs are currently in operational tests.
5. Easily replaceable components are part of the development of the innovative s&c solutions in INNOTRACK. The solutions are being assessed from a logistics point of view.
6. Automated maintenance methods have been a major topic in INNOTRACK. Different algorithms for error detection have been developed and tested in laboratory and in field. Details are available in deliverables D3.3.3 *Requirements and functional description for s&c monitoring*, D3.3.4 *Algorithms for detection and diagnosis of faults on s&c*, D3.3.5 *Draft specification of the monitoring demonstrator*, and D3.3.6 *Quantification of benefits available from switch and crossing monitoring*. Regarding hollow sleepers, a draft specification has been developed, see D3.2.2 *Functional requirements for hollow sleepers for UIC 60 and similar types of switches*. This specification has been forwarded to the CEN where a wor-

king group is currently adopting it to a European code.

In addition, major efforts have also been targeted towards driving and locking devices. This includes the draft of an open standard interface for electronic interlocking, see D3.2.3 *Functional requirements for the open standard interface for electronic interlocking*, and D3.2.5 *Technical and RAMS requirements/recomendations for the actuation system, the locking and the detection device for UIC 60-500/1200 switches*.

## 3.5 S&C: Cracked manganese crossings

The failure of manganese crossings is a consequence of high vertical and lateral contact forces in combination with poor contact geometry. The priorities for innovation to mitigate these are included in the priorities for innovation outlined in section I.4. Consequently the relevant studies in INNTRACK outlined above are equally relevant in this context.

It can also be noted that within INNTRACK new steel grades for crossings have been tested in the laboratory and are undergoing service tests. Details are available in the guideline D3.1.6 *Recommendation of, and scientific basis for, optimization of switches & crossings – part 2*. The service tests will be reported in D3.1.7 *Results from laboratory testing of frog materials in Kirchmöser*.

## 3.6 Rail: Corrugation

### Causes

Rail corrugation is a surface defect of the rail, manifested as periodic wear or plastic deformation. If the corrugation is not removed it will cause high levels of wheel rail noise and crack initiation.

The mechanism of corrugation can always be defined as the result of both dynamic and structural factors. For corrugation to occur, a wavelength fixing mechanism and damage mechanism are required. For this reason the rate of corrugation formation and corrugation characteristics will depend on several vehicle and track related factors in complex interaction.

Current practice consists predominantly of using grinding regimes as corrective action by removing existing corrugations, and preventive action by removing other defects that may trigger dynamic forces and by restoring optimum wheel rail contact condition. Harder steel rails may be used on curves to also reduce wear and deformation.

### Priorities for Innovation

1. Rail steel grades resistant to corrugation
2. Optimised wheel and rail profile management
3. Rail pads and other rail damping devices designed to minimise formation of corrugation
4. Innovative rail and sleeper support systems designed to decouple natural frequencies of vehicles and track
5. Methods to manage railhead friction, through use of engineered friction modifiers.
6. Optimised grinding strategy for corrugation management

### How INNTRACK has addressed these priorities

1. The influence of rail steel grades is part of the study on rail grade selection discussed in section 3.1 above. However, note that neither the deliverables on rail degradation algorithms nor the rail grade selection guideline discuss the subject of corrugation – this is an area where little data was available from organized and controlled track trials.
2. In INNTRACK, a method of determining allowable magnitudes of corrugation has been developed. This method is based on validated models for predicting vertical and longitudinal rail–wheel contact forces and resulting noise emission and risk of RCF formation. By this numerical assessment method, the effects of mitigating actions as proposed here e.g. in D4.5.5 can be assessed through numerical simulations before field tests are initiated. Details are given in D4.2.1 *Estimations of the influence of rail/joint degradation on operational loads and subsequent deterioration*, D4.2.4 *Improved model for loading and subsequent deterioration due to squats and corrugation*, and in the guideline D4.2.6 *Recommendation of, and scientific basis for minimum action rules and maintenance limits*.
3. See 2 above
4. See 2 above
5. This has to some extent been addressed in deliverable D4.5.4 *Friction management methods*.
6. This has been addressed in guideline D4.5.5 *Guidelines for management of rail grinding*.

## 3.7 Poor track geometry – Wrong or unknown stress free temperature (SFT)

### Causes

High rail temperatures as compared to the stress free temperature result in the necessity to impose speed restrictions, and hence train delays, due to the increased risk of track buckling. This may be a real risk due to the rail temperature exceeding the safe limit established from the rail stressing procedure, or a potential risk due to lack of confidence in the stress free temperature (SFT) in a track section. The problem for the track maintainer is that the SFT is almost always unknown and non-destructive and non-invasive measurement technologies capable of continuously characterising the SFT of continuously does not exist. Climate change may result in more delays due to speed restrictions imposed as a result of hot rails, raising the priority for solutions to this problem condition.

### Priorities for innovation

The need for a continuous and non-destructive technique to measure the SFT is generally recognised as the primary innovation for SFT maintenance as shown below. Other areas for possible improvement include:

1. Non invasive methods for determining rail SFT
2. Guidelines for SFT maintenance related to the repair of broken rails during cold weather
3. Evaluation of current SFT and rail stressing requirements in and around switches & crossings.
4. On board train sensors for monitoring rail stress
5. Improved or novel rail support to increase the rail buckling temperature
6. Rail section designed for increased buckling resistance

### How INNOTRACK has addressed these priorities

The issues of rail buckling and evaluation of stress free temperatures has not been an explicit topic of INNOTRACK. There is however high competence in this area in the consortium. A good starting point for the current state-of-the-art is the Kabo *et al* (2004).

This report was the starting point for a fairly recent and very extensive study that included charting and development of methods for SFT evaluations as well as evaluation of lateral track resistance and the risk of track buckling. The project is summarized in Johnson *et al* (2007) where also the 20 reports of the project (13 in English) are listed.

Further, a trial evaluation of a non-invasive technology for the measurement of the longitudinal stress developed by Goldschmidt as part of a track trial installation of novel rail welding technologies is expected to be undertaken on an IM and supply industry partnership outside the scope of INNOTRACK.

### References

1. Elena Kabo, Anders Ekberg & Lars Jacobsson, Railway track stability – a state-of-the-art survey, *Chalmers Applied Mechanics*, Report 2004:2, 94 pp, 2004
2. Erland Johnson, Gunnar Kjell, Robert Lilbacka, Elena Kabo & Anders Ekberg, Lateral spårstabilitet – slutrapport (in Swedish), *Chalmers AppliedMechanics*, Report 2007:04, 35 pp, 2007

## 3.8 Rail welds

### Causes

Rail welds are track discontinuities with regard to their metallurgical and mechanical properties. Rail welds tend to have lower hardness in the adjacent heat affected zones in comparison to the parent rail. Weld microstructures may also vary significantly from the parent rail. Two weld types comprise the majority of welds used in rail service: aluminothermic welds and electric flash-butt (EFB) welds.

Aluminothermic welds are susceptible to porosity and cleanliness problems, such as inclusions, typical of cast structures. Aluminothermic weld production is highly operator dependant and as a result may experience significant variation in weld quality. EFB welds are much less operator dependant and produce the highest quality welds.

### Priorities for innovation

1. Develop rail welding methods that incorporate the portability and cost benefits of aluminothermic welding and the weld quality of EFB welds.
2. Weld treatment methods that improve the metallurgical and mechanical properties of adjacent heat affected zones, in aluminothermic welds.

### How INNOTRACK has addressed these priorities

1. Along with currently available techniques, such as mobile flash butt welding (MFBW) plants, gas pressure welding, which is a new method for the European market has been investigated in the project. Details on these investigations may be found in deliverables D4.6.3 / D4.6.4 *Analysis of equipment design and optimisation of parameters for gas pressure welding*, and D4.6.5 *Gas pressure welding – Quality of test welds*.

2. Extensive research and development has been put into this area. The work and results are described in the deliverables D4.6.1 *Report on the influence of the working procedures on the formation and shape of the HAZ of flash butt and aluminothermic welds in rails*, D4.6.2 *Report on the influence of working procedures and post treatment on static and dynamic fatigue behaviour of aluminothermic welds*, and D4.6.6 *Weld performance in track test – supervision of weld properties in terms of rail profile, rail straightness and neutral temperature*.



# TRACK SUPPORT AND SUPERSTRUCTURE 4

# TRACK SUPPORT AND SUPERSTRUCTURE

Florence Margiocchi and Jérôme Chalansonnet, SNCF

Nowadays, the European railway network still consists mainly of old conventional lines where the design for the most part is not optimized and the subgrade, which has often been neglected for years, is of a poor quality (contrary to new lines). As the operational loading and the traffic density are currently increasing due to economic developments, there are needs to get a better knowledge of these tracks, and to investigate possible subgrade improvements – in order to bring them to an acceptable level of quality and capacity – and new superstructure designs. The sub-project “Track support and superstructure” of INNOTRACK aimed to answer these three aspects.

In order to satisfy the first point, the work package “Subgrade assessment” had the following objectives:

- To assess and monitor parameters vital to subgrade performance on experimental sites with both poor and good quality areas regarding maintenance, as well as specific zones (such as transition zones between plain track and bridge). A database has here been constructed and the results of measurements uploaded for comparisons and further studies.
- To develop new tools and methods for the investigation of a set of subgrade characteristics.
- To propose an innovative substructure assessment method, based on a comprehensive analysis of different parameters.
- To investigate poor quality sites both through long term laboratory experiments and numerical simulations.
- To determine and model the variability of the geotechnical properties of the subgrade.

The objectives of the second work package “Subgrade improvements” were to provide evaluation and implementation of innovative methods of track substructure retrofitting, allowing higher levels of duty loads with a minimal impact on track availability and costs. Several innovative improvement methods have been identified and tested using numerical and physical modelling and/or by applying the methods on selected sites:

- Reinforcement with geogrids at the ballast/sub-ballast interface: laboratory experiments, numerical modelling and in-situ testing have been achieved to evaluate the performance of this technique.
- Cement mixing columns: numerical modelling from a previous in-situ test has been done
- Inclined cement columns below the embankment have been tested in situ with no impact on train traffic.
- Improvement of a transition zone between plain track and a culvert passage has been monitored before and after treatment.

As the ballasted track concept is historical in the railway domain, the third work package “Superstructure optimisation” aimed to study alternative support systems, designing, evaluating and testing innovative superstructure solutions:

- An innovative modular track support structure produced from a steel–concrete–steel composite technology, successfully used in the construction and defence sectors.
- An innovative embedded rail technology that allows for optimised rail support and efficient slab track design and construction.

## 4.1 Subgrade assessment

The key point in improving subgrade conditions is an understanding of what the current conditions are and what effect this will have on the operating traffic. To this end, INNOTRACK has made significant efforts in the field of subgrade assessment. One key issue is here to interpret and compare results obtained by different measurement techniques. As is described in section 4.1.1, INNOTRACK has adopted a number of techniques including various geophysical methods, rolling stiffness measurement methods and methods able to obtain point-wise depth dependent profiles of the subgrade resistance.

To being able to evaluate, compare and retrieve the massive amount of data collected, significant efforts have also been put into storing the data in an easy-to-access database. Apart from providing an operational tool where data obtained by different methods can be stored, this database will also provide the possibility for long-term storage to compare and evaluate trends over time.

A key issue is the stiffness in transition zones. If the stiffness transition is not designed and maintained in a proper manner the consequence may be significant costs and operational disturbances. Much efforts in INNOTRACK have been devoted to analysis and mitigating actions related to stiffness transitions.

In addition to measurements, and evaluation of measured data, INNOTRACK also features a significant amount of numerical simulations. Among other things, these simulations provide a link between measurements and operations in the sense that they can be used to predict consequences of operational conditions, e.g. in the form of increased axle loads. In this analysis the major statistical scatter in subgrade conditions is a major complicating factor. How to account for this scatter in a stringent manner has been addressed in INNOTRACK.

## 4.1.1 The measurement campaigns and database of results

Gerhard Huber, Universität Karlsruhe

More information on the database is available in deliverables D2.1.1, D2.1.8 and D2.1.14.  
For contents see D2.1.2, D2.1.4, D2.1.5, D2.1.6, D2.1.7, D2.1.9, D2.1.10, D2.1.11, D2.1.13, D2.1.15 and D2.2.4.

### Background

This section describes the measurement campaign for track bed quality assessment including the problems encountered. The campaign includes the following measurement sites:

- Czech Republic (Bechovice, Lipnik, Polom): repeated degradation of track geometry especially track level, mainly caused by subsoil conditions
- France (Cavaillon, Chambéry, Port Autonome de Rouen): testing of assessment methods with and without testing vehicles, quality of drainage condition
- Germany (Bad Krozingen, Uelzen, Nordenhain): evolution of track irregularities, state of embankments and trenches
- Spain (Montagut, Lleida): improvements of sub-ballast layers at subsoil and comparisons between different transition zones
- Sweden (Central part, West coast, Torp): assessment of large track segments and soil improvement of soft soil embankment with inclined lime columns

The major task of the campaigns was gathering of data along the track (longitudinal data) monitoring of the state of track and/or its variations.

### Applied tools

Geophysical methods being applied are non destructive. They are able to identify the variations of profiles through layers like ballast, sub-ballast, subsoil etc. at least along track line ( $x$ -axis). Methods applied are:

1. Seismic methods that use transmission, refraction and reflection of elastic

waves. Results are spatial distributions of wave speeds, in general cuts over 2 dimensions (2D) over  $x$  and depth  $z$ . Areas with same order of wave speeds are assigned the same material properties.

2. Resistivity measurements that are very sensitive to the spatial distribution of the water content.
3. Time domain reflectometry (TDR) detecting changes on permittivity. This method allows identifying the distribution of water contents with high spatial resolution.
4. Micro gravimetry measurements are used to identify deviations of the local gravity field. Applications are e.g. detection of fractures in rock masses.
5. Ground penetrating radar (GPR) is used to detect e.g. track sections being polluted with fine grained particles like higher moisture content at the lower boundary of the ballast layer or the depth of layers with high water content (near surface). Only GPR can also be applied on-board driving vehicles.

Results of the geophysical methods mentioned above are processed with inversion and/or tomography methods accordingly. Interpretation of the results related to a known soil profile is required.

Rolling Stiffness Measurement Vehicle (RSMV) and Portancemetre (for details see sections 4.1.3 and 4.1.4) are employed to determine the stiffness of the track in the vertical direction continuously along the track. Adjustable bias loading is provided with the test vehicles. Currently processing is based on transfer functions (linearized models). However, nonlinear models can

be adapted as well. They could be adopted for high magnitudes of the dynamic part and/or lower bias loading under sinusoidal excitation.

Dynamic soundings like PANDA or dynamic probe light (DPL) are interpreted as depth dependent profiles of the so-called dynamic cone resistance (each for single points at the surface). For comparable soil layers the results could also be used for density estimation. PANDA is a lightweight device and therefore very useful if the access is limited. It is equipped with an automated data acquisition system.

For identification of the soil, geodenscope, slotted probes or undisturbed sampling are used. The benefits of the geodenscope are that the soil stays at its place and that the loss of material, that is always a risk using slotted probes, is avoided with the geo-endoscope. However, the interpretation of images requires experience.

Local stiffness has been evaluated for passing trains at transition zones. Vertical ( $o$ ) forces are obtained from shear strain measurements at rails between sleepers and deflections evaluated using laser displacement measurements. Unlike measurements obtained from vehicles, the response is evaluated without bias loading.

The influence of the bedding conditions of the track has to be examined and “hanging sleepers” has to be avoided.

### The database

The data of all measurements including track irregularity measurements are included in the database. The data along the track line is supplied not only for historical reasons. It appears to be advantageous also for the approach used here and for the basic concept arranging the data. Information of area (2D) of maps was also included for convenience of the user.

A web based front end allows a tree structured overview and selection of available data. Descriptions of contents and reports are also accessible. Data included in the database can be structured (raw or processed data) or unstructured (images or graphs from processing software). Created previews of structured data (mainly results and site information) can be used for visual correlation without any further processing.

A simple example shows the visual correlation of stiffness measured by the RSMV and sleeper type for the site at Chambéry in France. The results indicate the dependence on stiffness of the types of sleepers, see Figures 4.1.1-1 and 4.1.1-2.

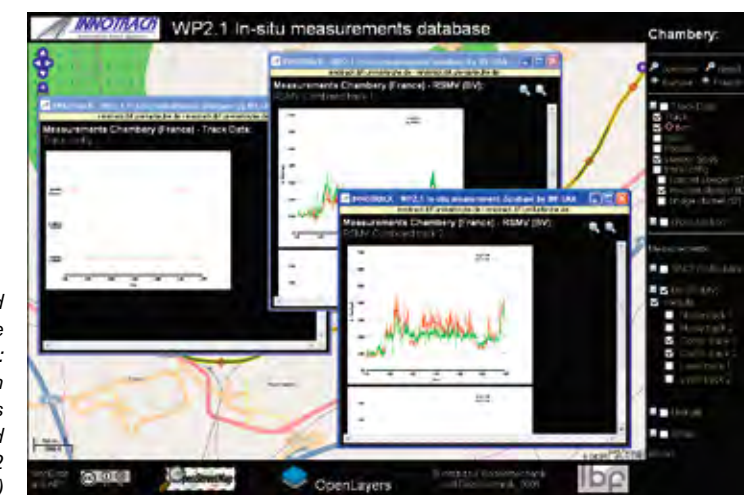

Figure 4.1.1.-1: Selected previews from database for site Chambéry: sleeper-types vs. position (SNCF), RMSV stiffness (magnitude of combined data) for track 1 and 2 (BV)

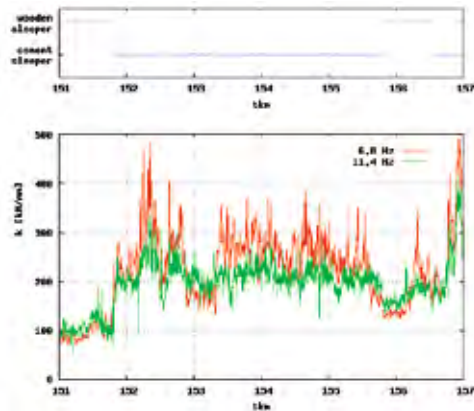

Figure 4.1.1-2: Previews from database for site Chambery for visual correlation: sleeper-types vs. position, RMSV stiffness (magnitude of combined data) for track 2

A two-step approach using XML (Extensible Markup Language) was adopted. A rule set was created to validate the XML-files. In a first step a set of definitions down to the low level of single data was created, see D2.1.8. The approach implemented here is based on that structure but only metadata (information on the structure of files and their relations) are used for the database, see D2.1.14. The corresponding XML-files for each site had to be created. The web front end is generated from a rule set and the XML-files.

#### Examples of benefits from the database of measurement results

The database gives a detailed overview of the obtained results. It is not only a well-organized set of measurement data. The previews included allow fast access to results supplied as structured data. Even at this stage many relations can be inspected by visual correlation. A benefit of the common longitudinal scale is that e.g. previews of measurement results and site conditions can be displayed and compared directly. For further usage an easy export and drag-and-drop function is contained.

The XML organization allows the data contained in the database to easily be imported into any other database.

The evolution of track irregularities along the track, stiffness-based measurements like RMSV together with track related data (sleeper type, slope, embankment, geological conditions, etc.) allows detecting sensitive sections or spots. Depending on the evolution of these sections, decisions could be made whether only a decreased tamping interval or an improvement below the ballast is required.

#### Open questions

For future projects a uniform scheme for measured and processed data like XML should be used for all data down to the individual dataset. The acquisition and processing tools that are currently used mainly do not have this functionality.

The current version of the database uses Geographic Information System (GIS) data from an open software project. The property rights of these map data have to be considered if the convenient map oriented view of data are used for commercial applications.

#### References

1. INNTRACK Deliverable D2.1.1, In-situ measurement preliminary database, based on information management framework, 17 pp, 2008
2. INNTRACK Deliverable D2.1.2, Adapted "Portancemetre" for track structure stiffness measurement on existing tracks, 27 pp (and 4 annexes 7+2+3+3 pp), 2007
3. INNTRACK Deliverable D2.1.4, Report on sampling and analysis of geotechnical test results, 88 pp (and 1 annex 11 pp), 2009 [restricted to programme participants]
4. INNTRACK Deliverable D2.1.5, Methodology of geophysical investigation of track defects, 28 pp, 2009
5. INNTRACK Deliverable D2.1.6, RSMV Stiffness Measurements, 23 pp (and 1 annex 59 pp [extract]), 2009
6. INNTRACK Deliverable D2.1.7, Investigations with PANDA /Geoendoscope – Results and analysis of measurements, 44 pp (and 10 annexes 46+8+8+12+21+1+45+9+1+1 pp), 2009 [restricted to programme participants]
7. INNTRACK Deliverable D2.1.8, In-situ measurement database, based on information management framework, 33 pp (and 2 annexes 82+24 pp), 2009 [restricted to programme participants]

8. INNTRACK Deliverable D2.1.9, Adapted "Portancemetre" for track structure stiffness measurement on existing tracks, 56 pp (and 6 annexes 1+1+1+2+1+1 pp), 2009 [restricted to programme participants]
9. INNTRACK Deliverable D2.1.10, Study of variation of vertical stiffness in transition zone, 94 pp (and 10 annexes 7+1+9+1+6+26+31+30+1+9 pp), 2009 [restricted to programme participants]
10. INNTRACK Deliverable D2.1.11, Methods of track stiffness measurements, 36 pp, 2009
11. INNTRACK Deliverable D2.1.13, Stiffness data processing and evaluation, 7 pp (and 1 annex, 9 pp), 2009
12. INNTRACK Deliverable D2.1.14, Concluding update of D2.1.8, 30 pp (and 4 annexes 4+13+3+1 pp), 2009 [restricted to programme participants]
13. INNTRACK Deliverable D2.1.15, Non-destructive geophysical methods, 17 pp (and 8 annexes, 16+10+13+10+7+7+9+6 pp), 2009 [restricted to programme participants]
14. INNTRACK Deliverable D2.2.4, Description of measurement sites + LCC reference sites, 57 pp, 2009 [restricted to programme participants]

## 4.1.2 The concept of onset of settlement

Gerhard Huber, Unikarlsruhe

More information is available in deliverable D2.1.4.

### Background

Railway lines suffer settlements caused by the passage of trains. The vehicle passages subject the track construction and the subsoil to a huge number of shear cycles. An evolution of track irregularities occurs since these layers behave non-uniformly. Increasing vehicle speed or axle load can lead to a pronounced increase of settlements.

In INNOTRACK, an assessment of the onset of settlements was evaluated for cyclic and dynamic loading. While increasing the shear strain  $\gamma$ , at a certain level an onset of settlements is observed. For applications on construction and soil layers under railway tracks, the shear strain under the track has to be estimated. In many cases this is carried out by assigning measured velocities as particle velocities of a shear wave  $v_s$ . For plane shear waves the shear strain is then given by  $\gamma = v_s/c_s$ , with shear wave velocity  $c_s$ . In the case of a near field of a moving load this approximation is not appropriate. A different approach is required.

### Applied tools and methods

In a first step the shear strain levels for ballast layer (in case of a conventional track), substratum and subsoil have to be estimated. The magnitude of shear strain  $\gamma$  was assessed by finite element (FE) calculations for the moving load problem with a linear 2-dimensional elastic model (2D) for the subsonic case. The load distribution of the track was taken from previous research projects. The results of the FE-simulations were verified for zero speed by comparing to the static solutions. The distribution of shear strain versus depth, its dependences on elastic properties and train speed were evaluated. Only the upper layers with the highest shear strain magnitudes are of in-

terest. For a homogeneous material (with the properties shear-modulus  $G=42.5 \text{ MN/m}^2$ , Poisson's ratio  $\nu=0.3$ , mass density  $\rho=1800 \text{ kg/m}^3$ ) roughly the first 2.5 m below the track have to be considered. The moving pair of loads considered is equivalent to a boogie with an axle load of 200 kN. This estimation concerns only the deterministic part. Imperfections of wheels, rails, track support etc. as well as their interactions increase the level of vibration. These effects are not considered here. The particle velocities increase with train speed, e.g. a value of about 40 mm/s (depth 0.1m) is obtained for a train speed of 50 m/s. Only a low increase of the shear strain is found for train speeds lower than 50% of the velocity of the shear wave. For a train speed of 50 m/s the maximum shear strain magnitude  $\gamma$  occurred in the subsoil at a depth of about 1 m with  $\gamma$ -values of about  $6 \cdot 10^{-4}$ . An increase of the  $G$ -modulus in the model reduces  $\gamma$  and vice versa. The 2D-model overestimates slightly the shear strain level.

The shear strain level for an onset of settlements was found with resonant column tests at a shear strain level  $\gamma$  of  $2 \cdot 10^{-4}$  to  $5 \cdot 10^{-4}$ . This required shear strain level is common for resonant column (RC) devices. One of the advantages of the RC-device is that due to the range of the resonance frequency a large number of cycles can be gathered in short time.

During the test the sample in the RC-device is subjected to a large number of cycles and with stepwise increasing amplitudes. The state of the sample is changing and therefore also the natural frequency also. For continuous operation the automated control of the phase condition for resonance was used.

### Increased knowledge, implementable results and related cost reductions

The results applied to test sites considered in INNOTRACK could explain for which cases settlements occur. Sections or spots with progressing track irregularities are found. For an approximation only the onset from some samples has to be gained. For similar soil conditions the shear stiffness expressed as  $G$ -modulus or shear wave velocity can be used for identification. Since lower  $G$  values lead to higher shear strain, measured values could be compared with the onset level. In many cases less expensive tests based on transmission of ultrasonic shear waves through samples are sufficient if the materials are comparable and differ only in their shear stiffness (state).

A validation of the concept requires more sites with failures to be examined. The ideas for this approach had been developed during the project. Additionally an improvement of the RC-test has been carried out. The method for testing coarse-grained material as it is applied at transition zones has been successfully modified and used within the project.

### Open questions

The 2D linear FE-model applied for the moving load problem has to be improved at least in allowing for an increasing stiffness with depth. This will have a non-negligible influence on the shear strain distribution. It is expected that the evaluated shear strain level with this modification will increase near the surface and decrease with depth.

The computing time for the 2D linear model is up to tens of hours for a multi-processor computer server. Moving load problems require huge model sizes to

prevent reflections at least from the lower boundary. Thus for certain cases a 3D model could be developed. The use of constitutive relations for soils that include the non-linear behaviour cannot be covered by this approach, due to the computational demands.

The influence of the stress ratio on the onset of settlements needs further attention.

### References

1. INNOTRACK Deliverable D2.1.4, Report on sampling and analysis of geotechnical test results, 88 pp (and 1 annex 11 pp), 2009 [restricted to programme participants]

### 4.1.3 The concept of track stiffness

Eric Berggren, Banverket and Gilles Saussine, SNCF

More information is available in deliverables D2.1.1, D2.1.2, D2.1.6, D2.1.7, D2.1.8, D2.1.9, D2.1.10, D2.1.11, D2.1.13, D2.1.14, D3.1.11.

#### Background

Historically, most attention has been paid to inspection techniques targeted at the superstructure. Several such techniques are standard measurements used worldwide. Inspection of substructure has been given much less consideration, especially the subballast and subsoil components, even though it has a major influence on the cost of track maintenance. Most of the substructure investigation techniques are not standard measurements and are not performed regularly.

The term *global stiffness* is used if the whole track structure is considered. It is often measured as applied force to rail divided by rail displacement. Global track stiffness varies both with frequency, dynamic amplitude, applied preload and position along the track. Global track stiffness is an important interaction parameter in the wheel/rail contact, and variations of track stiffness as well as extreme values (both low and high) will affect the degradation of the track. Global track stiffness can be measured both at standstill and while rolling along the track.

*Local track stiffness* of components can often be quantified from lab-tests by the manufacturer. Usually also the variability of the local track stiffness can be quantified. Local stiffness of different layers can be measured in laboratories if soil-samples are used, however there are also methods for site investigations by means of cone-penetration tests and similar.

The work done in the frame of INNOTRACK focuses on condition monitoring techniques to assess the vertical stiffness of the track. The results of measurement campaigns have been included into the measurement database described in section 4.1.1.

In the following we present the techniques used within INNOTRACK to investigate track stiffness; motivations with regard to maintenance and some open points for further research.

#### Increased knowledge on global stiffness measurement techniques

The *Rolling Stiffness Measurement Vehicle* (RSMV) is a rebuilt two-axle freight wagon equipped with loading and measurement devices. The track is dynamically excited through two oscillating masses above an ordinary wheel axle. The track stiffness is evaluated from measured axle box forces and accelerations. The dynamic stiffness is a complex valued quantity, represented by its magnitude and phase. While the magnitude is the direct relation between applied load and deflection (kN/mm), the phase is a measure of deflection-delay in comparison to the applied force. The phase has a partial relationship with damping properties and ground vibrations.

The static axle load of the RSMV is 180 kN and the maximum dynamic axle load amplitude is 60 kN. The RSMV can measure the dynamic track stiffness up to 50 Hz. Both overall measurements at higher speeds (up to 50 km/h) with 1 to 3 simultaneous sinusoidal excitation frequencies or detailed investigations at lower speeds (below 10 km/h) with noise excitation can be performed. The RSMV has been in use since 2004 and several hundreds kilometres of track have been measured. The reasons for measurements have varied between for example measurements to support research, to investigations of specific issues, e. g. upgrading of a track for higher axle load.

The *Railway Portancemetre* (see section 4.1.4) is a new apparatus designed and

built in the frame of the project. It is made of a vibrating wheel axle (wheel-set) to measure the dynamic stiffness of the railway track. It includes an un-sprung mass (a vibrating wheel axle) and suspension mass instrumented by accelerometers on both axle sides. The track is excited through a dynamic force generated by two electric vibrators with adjustable eccentricity. The total applied force is calculated by vector summation of all acting components. The vertical displacement is calculated by double integration of the wheel acceleration.

The fabrication of the demonstrator of the Portancemeter was done in February of 2009. Since then a series of measurements have been performed. The maximum running speed for the demonstrator is about 15 km/h and the calculation of the stiffness is done on post treatment for both left and right rails. At present, the irregularities of the rails in the stiffness calculation and the influence of the phase between force and displacement are ignored.

#### Increased knowledge on local stiffness measurement techniques

The procedures to evaluate the stiffness of a short portion of railway have been based on *the use of sensors external to the track mounted on the rails* (used e.g. by ADIF, CEDEX). They have been used to detect the wheel loads and the rail movements induced in the track by trains operating the railway lines during the measurements. The wheel loads have been assessed by a method based on the determination of the maximum shear stress induced in the rail cross section by the train passages, while both direct and indirect methods have been adopted for measuring rail deflections.

*Penetration testing* (static or dynamic) is widely used all over the world. It consists of driving a calibrated cone through the granular material and recording the data representing the driving resistance with depth. The penetrometer PANDA has been used for several years for investigations on railway track. The main advantage of this

test consists in its quick set-up and its local measure recording, which allows precise information on the granular material resistance and estimation of the variability in material behaviour. Provided that physical properties of the material are known, it is possible to find the in situ density of the studied granular material on the basis of the cone resistance. This technique has been applied for several years in order to provide control over the quality of road embankments (French standard XP 94-105). Nevertheless penetration testing is a “blind” test and a complete approach to granular material characterisation necessitates a material identification. Nowadays this identification is possible thanks to an endoscope introduced in the cavity created during the penetration test.

For the railway track it is important to underline these different points:

- The PANDA penetrometer and the endoscope are non-destructive tests, with a very light setup. They can be easily used to investigate a railway track.
- The information can be collected for each point of the track. It is clearly possible to do some tests with only 1 hour of halted traffic and there is no restriction as to the time of year to do these kinds of tests.
- From the measurements it is possible to obtain local information about the properties of the track, in particular an evaluation of the track stiffness. By employing some statistical concepts it is possible to have a continuous description of the track properties from a set of tests.

#### Implementable results: some proposals for maintenance

There are several areas where track stiffness measurements have a potential for supporting track maintenance decisions: They can act as indicators of root causes at problem sites. They can aid in the upgrading of tracks for higher speed and/or axle load, and in verifications of newly built tracks. Points to consider include:

- Measurement of track geometry quality is the most commonly used automated condition assessment technique in railway maintenance. Most problems with the track (at least the ones concerning the ballast and substructure) will be visible as track geometry irregularities. However the root cause of the problem is not detected with the help of track geometry measurements. In these cases, track stiffness measurements can help in finding the root cause of the problem, e.g. a transition zone, the presence of water, or a weak subgrade.
- In upgrading a track, there are many aspects that have to be considered: bearing capacity, stability, and future maintenance needs of the track. Infrastructures, like for example bridges, are in some sense known structures in terms of materials and can be subjected to visual inspections. The substructure of the track is on the contrary often unknown and only limited visual inspection is possible. The possibility to measure the vertical track stiffness could be a help for determining which sites along the track that needs of substructure reinforcement or further investigations.
- For a verification of a newly built track there is currently a lack of recommendations for allowed track stiffness variability. However the recommendation from the Eurobalt II project was that variations in the stiffness of the subgrade should be limited to less than 10% of the mean value. With the help of continuous track stiffness measurements, it is possible to verify the stiffness of newly built tracks; both regarding magnitudes and variability.

#### Open questions

Stiffness measurement techniques have developed into almost mature methods for condition assessment of the track substructure. The use of the obtained data is still partly an open question. Stiffness data is one part of the condition, but other parts are needed as well. Besides track geometry quality, also georadar and penetrometer data are beneficial for condition assessment. There is a need for more investigations to

establish relations between different condition data and the best way to combine them.

As much work has been put into track stiffness measurements, the next step might be to start standardization work in this area. Both measurement techniques and recommended values could be taken into consideration.

#### References

1. INNOTRACK Deliverable D2.1.1, In-situ measurement preliminary database, based on information management framework, 17 pp, 2008
2. INNOTRACK Deliverable D2.1.2, Adapted "Portancemetre" for track structure stiffness measurement on existing tracks, 27 pp (and 4 annexes 7+2+3+3 pp), 2007
3. INNOTRACK Deliverable D2.1.6, RSMV Stiffness Measurements, 23 pp (and 1 annex 59 pp [extract]), 2009
4. INNOTRACK Deliverable D2.1.7, Investigations with PANDA /Geoendoscope – Results and analysis of measurements, 44 pp (and 10 annexes 46+8+8+12+21+1+45+9+1+1 pp), 2009 [restricted to programme participants]
5. INNOTRACK Deliverable D2.1.8, In-situ measurement database, based on information management framework, 33 pp (and 2 annexes 82+24 pp), 2009 [restricted to programme participants]
6. INNOTRACK Deliverable D2.1.9, Adapted "Portancemetre" for track structure stiffness measurement on existing tracks, 56 pp (and 6 annexes 1+1+1+2+1+1 pp), 2009 [restricted to programme participants]
7. INNOTRACK Deliverable D2.1.10, Study of variation of vertical stiffness in transition zone, 94 pp (and 10 annexes 7+1+9+1+6+26+31+30+1+9 pp), 2009 [restricted to programme participants]
8. INNOTRACK Deliverable D2.1.11, Methods of track stiffness measurements, 36 pp, 2009
9. INNOTRACK Deliverable D2.1.13, Stiffness data processing and evaluation, 7 pp (and 1 annex, 9 pp), 2009
10. INNOTRACK Deliverable D2.1.14, Concluding update of D2.1.8, 30 pp (and 4 annexes 4+13+3+1 pp), 2009 [restricted to programme participants]
11. INNOTRACK Deliverable D3.1.11, Results of continuous RSMV stiffness measurements on switches at DB, 16 pp (and 7 annexes 1+1+1+1+1+1+1 pp), 2009 [confidential]

## 4.1.4 A new tool for track stiffness investigations: the Portancemeter

Hugues Vialletel, CETE (LCPC)

More information is available in deliverable D2.1.1, D2.1.2, D2.1.8, D2.1.9, D2.1.14

#### Background

The INNOTRACK project enabled the study, development, construction, set-up and testing of a demonstrator for measuring the stiffness of railway tracks in service. It is based on the principle of the Road Portancemeter MLPC, which has already proved its efficiency in the domain of roads and railways in Europe for the acceptance of new platforms.

The demonstrator consists of the measuring core and a technical carriage, which was designed in order to perform measurements as simply as possible.

The demonstrator was tested on a private track according to different operation configurations of displacement speed, frequency of vibration, adjustment of eccentric moment, static and dynamic load. Finally, the system was used on a reference track closed to railway traffic. Different operating modes were implemented and other means for checking the track stiffness were undertaken in order to compare the Road Portancemeter, PANDA and RSMV.

#### Increased knowledge and implementable results

The results of deflection measurements calculated over 30 vibration periods with the Railway Portancemeter are very repeatable. The levels of deflection are different depending on the operating modes of the system but the shape of the curves obtained indicates weak and strong points. Consequently, the qualitative measurements of platform stiffness are correct with the demonstrator.

In order to apply sufficient effort on the track to obtain a deflection that is sensitive to the structure of the sub-grade, the frequency of the vibration must be greater

than some 20 to 25 Hz. This operating range shows variations of deflections, which agree with the variations of resistance measurements made with the Panda system.

For the time being, the measurements of deflection seem to be a good indicator for the study of the railway track stiffness.

The Railway Portancemeter demonstrator set-up appears to comply with the expectations of the determination of the sub-grade under the ballast. It is sensitive to the variations of structure with depth.

#### Open questions

Additional test campaigns should be performed to study more specifically the interaction between the stiffness of the track and its geometry.

Additional tests are necessary to study the influence of different types of structures on the measured deflection and to determine the operating depth of the system. These tests are also needed to determine operating parameters (frequency, static and dynamic mass...) best adapted to different track types.

A further study phase could be envisaged and be more specifically turned to the integration of the core of the Portancemeter measuring system in a homologated carriage capable of rolling on the European commercial railway network.

#### References

1. INNOTRACK Deliverable D2.1.1, In-situ measurement preliminary database, based on information management framework, 17 pp, 2008
2. INNOTRACK Deliverable D2.1.2, Adapted "Portancemetre" for track structure stiffness measurement on existing tracks, 27 pp (and 4 annexes 7+2+3+3 pp), 2007

3. INNTRACK Deliverable D2.1.8, In-situ measurement database, based on information management framework, 33 pp (and 2 annexes 82+24 pp), 2009 [restricted to programme participants]
4. INNTRACK Deliverable D2.1.9, Adapted "Portancemetre" for track structure stiffness measurement on existing tracks, 56 pp (and 6 annexes 1+1+1+2+1+1 pp), 2009 [restricted to programme participants]
5. INNTRACK Deliverable D2.1.14, Concluding update of D2.1.8, 30 pp (and 4 annexes 4+13+3+1 pp), 2009 [restricted to programme participants]

## 4.1.5 Poor quality sites modelling: laboratory experiments and numerical simulations

Leos Hornicek, CTU

More information is available in deliverables 2.1.3 and 2.1.16

### Background

From a geotechnical point of view, the characteristics of secondary and regional railway lines in comparison with main lines are the lower quality of subgrade and the lower level of maintenance. Hence, it is necessary to find solutions for so-called poor quality sites.

The behaviour of poor quality sites was investigated in INNTRACK by means of physical and numerical models. Physical modelling of poor quality sites involved the performance of physical modelling of substructure with a low bearing capacity of subgrade and a variable thickness of the ballast bed. The research objective was to determine the settlement of ballast beneath the sleeper and of the sub-ballast consisting of crushed stone mixture. Further, to measure the moduli of deformation, to assess the effect of varying ballast thickness on the magnitude of sleeper and sub-ballast settlement and the effect of a resilient under-sleeper pad under the sleeper on ballast and sub-ballast deformations.

A series of laboratory measurements on substructure models with dimensions of 2 x 1 x 0.8 m were performed in the experimental box of the Faculty of Civil Engineering at the Czech Technical University in Prague. The substructure was modelled in a 1:1 scale (Figure 4.1.5-1).

In order to ensure unchangeable characteristics, a layer of rubber simulated the subgrade. This layer had a known bearing capacity. To simulate poor subgrade two bearing capacities were chosen as expressed by static moduli of deformation of 20 MPa and 30 MPa (established using the German methodology). The subgrade

was overlaid with a sub-ballast layer of a crushed stone mixture with a constant thickness of 20 cm. A ballast bed with thicknesses of 25 cm, 35 cm and 45 cm was placed on the sub-ballast layer, and a concrete half-sleeper, with and without a resilient under-sleeper pad was mounted onto it. Individual model constructions were loaded with (quasi-)static loads corresponding to axle loads 22.5, 25.0 and 27.5 tonnes for some dozens of load cycles. Selected model constructions were also loaded with cyclic loads for a total of 250 000 load cycles. The settlements of both permanent way and substructure were monitored during the loading process, and the bearing capacity of the individual layers of substructure were successively determined by means of a static plate load test and an impact load test.

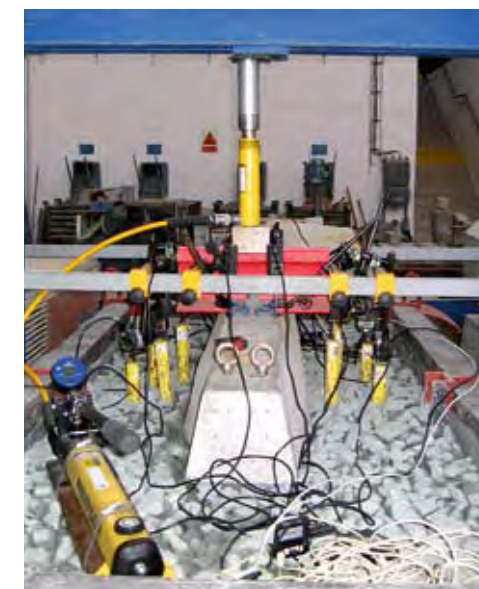

Figure 4.1.5-1: Laboratory measurement under short-term loading



A series of supplementary laboratory tests served for the determination of additional parameters.

#### Increased knowledge implementable results and related cost reductions

Results show that while increasing axle loads from 22.5 to 25.0 and 27.5 tonnes, the load increase amounts to 11 % or 22 %, respectively. Measured data imply that on models with a sleeper without an under-sleeper pad, the relative sleeper settlement increment under an increased load is lower than the load increment (108% and 118% for 25 and 27.5 tonnes, respectively). Another finding is that on models with a sleeper equipped with an under-sleeper pad the sleeper settlement can be more than 5 times greater than for models without the under-sleeper pad. In this case, the settlement increments in % resulting from higher loads were significantly lower (103% and 106%).

Finite element (FE) models for investigation of the bearing capacity of different designs of railway track substructure have been constructed and evaluated in a set of parametric studies. The FE models are designed as multilayer models in accordance with the laboratory experiments. Results from the numerical simulations were verified against the laboratory experiments. After verification, the FE models serve as an extension to further expand the results to a large number of parametric combinations. This would be very expensive to study experimentally. The first two sets of models were set up according to the experimental set-up (a part of the track bed in 1:1 scale) in which all the possible configurations were evaluated.

From the combination of experimental and numerical modelling a set of design graphs have been prepared (Figure 4.1.5-2).

These design graphs enable a swift evaluation of the required bearing capacity of a particular design of the railway substructure. The horizontal axis shows the modulus of deformation of the existing

subgrade. For each modulus of deformation of the sub-ballast a design curve is plotted. The vertical axis shows the sub-ballast thickness required to achieve a specific total modulus of deformation. These design graphs are easy to use and can be extended to any combination of layers as required. Using the numerical modelling it is also possible to prepare design graphs for multilayer constructions.

#### Open questions

It would be very useful to develop a universal diagnostic tool based on a particular analysis of the behaviour of poor quality sites that allows the design of an optimal solution from all points of view.

#### References

1. INNTRACK Deliverable D2.1.3, First phase report on the modelling of poor quality sites, 68 pp, 2008
2. INNTRACK Deliverable D2.1.16, Final report on the modelling of poor quality sites, 98 pp, 2009 [restricted to programme participants]

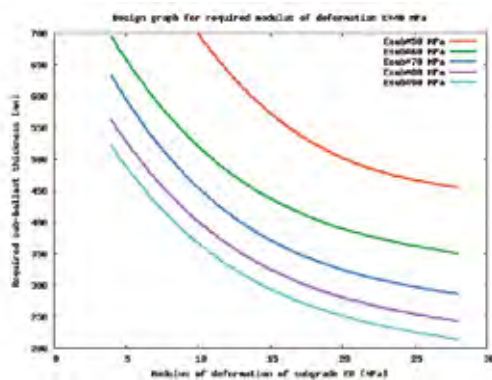

Figure 4.1.5-2: Example of design graph to obtain a required modulus of deformation  $E_{v2} = 40$  MPa

## 4.1.6 Numerical modelling: stochastic approach and accounting for variability

Noureddine Rhayma, SNCF

More information is available in deliverable D2.1.12

#### Background

The behaviour of track structures are strongly dependent on a number of uncertain parameters related to the operational conditions (drainage, settlements,...) and maintenance conditions of the track. A realistic description of the track behaviour requires that the variability of parameters is accounted for using a model based on a probabilistic approach.

The work in INNTRACK has led to the proposal of a method based on the use of Stochastic Finite Element Methods (SFEM) to evaluate the effect of uncertainties in geometrical and mechanical parameters on the model response.

#### Increased knowledge, implementable results and related cost reductions

To reach this goal, the stochastic collocation method using Lagrange polynomial interpolation is used to evaluate the sta-

tistical moments of the output model parameters. The uncertain parameters are modelled by a vector of independent log-normal random variables (r.v.).

The first step of the study was to develop a 2D multi-layer FE model of a railway track (Figure 4.1.6-1). The numerical model was validated towards experimental and numerical results.

Geometrical (thickness) and mechanical (Young's modulus) stochastic parameters are then selected. Their statistical representations have been deduced from in-situ measurement realized on various sections of railways tracks. The control parameters selected are indicators of the track behaviour: sleeper deflection and acceleration, rail deflection and a levelling indicator.

A preliminary convergence study of the proposed SFEM have shown that 4 collocation points is a good compromise between precision and CPU time, for the mean ( $m_{Y_i}$ )

and the standard deviation ( $\sigma_{Y_i}$ ), with geometrical and mechanical random input parameters.

An uncertainty propagation study has been conducted with one uncertain input parameter at a time. The influence of the selected parameters has been evaluated. In order to illustrate the influence of random parameters, the increase of the coefficient of variation for each control parameter,  $M_i$ , was computed as  $\Delta CV_{M_i} = \sigma_{M_i} / m_{M_i}$

Further, an uncertainty propagation factors was

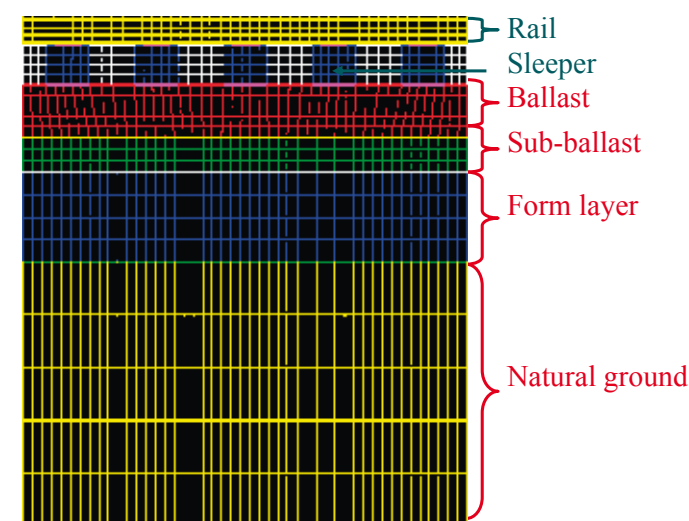

Figure 4.1.6-1: Detail of FE model mesh

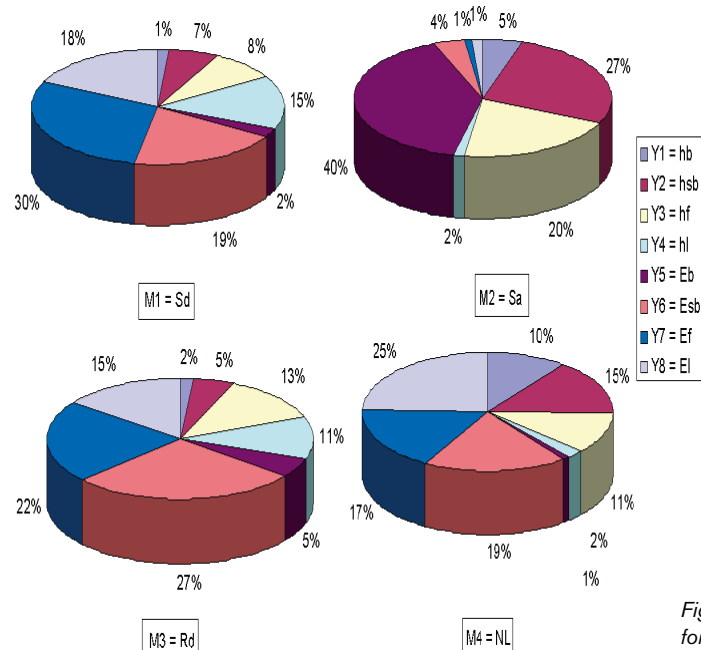

Figure 4.1.6-2: Uncertainty factors for the control variables  $M_i$

defined as the positive coefficients associated with each control variable  $M_i$ . The uncertainty propagation factor relative to the control variable  $M_i$  is defined,

$$\forall k \in \{1, \dots, 8\}$$

as:

$$\alpha_i(k) = \frac{\Delta CV_{M_i}(k)}{\sum_{j=1}^8 \Delta CV_{M_i}(j)}, i = 1, \dots, 4$$

Obtained results  $\alpha_i(k)$  corresponding to the control variables: sleeper deflection (M1), sleeper acceleration (M2), rail deflection (M3) and the levelling indicator (M4) are summarized in Figure 4.1.6-2. The random parameter corresponding to the largest value of this factor is thus the parameter having the largest influence.

Obtained results highlight the influence of the mechanical properties (Young's modulus) of subgrade layers (form-layer and sub-ballast layer) on most of the response parameters. The characteristics of the ballast layer has an important influence on sleeper accelerations.

#### Open questions

A next step to this work could be to account for the spatial variability of the parameters, as the description of the variability with a random field is more realistic than a description with random variable. Further exploitation of the results obtained by the collocation method could be a reliability analysis: scenario and failure criteria. This approach is based on the analysis of the probability that structures or structural elements exceed limit states given by design or safety rules.

Finally, this type of modelling, when coupled with simulation tools that can assess the long-term behaviour of the track (like relative settlement) could contribute in the design process of the track.

#### References

1. INNTRACK Deliverable D2.1.12, Modelling of the track subgrade: Part 1: Final report on the modelling of poor quality sites. Part 2: Variability accounting in numerical modelling of the track subgrade, 33 pp, 2009

## 4.1.7 Variation of track stiffness in transition zones

Miguel Rodriguez-Plaza, ADIF

More information is available in Deliverables D2.1.10 and D2.1.11

#### Background

Three in situ campaigns have been carried out to verify the behaviour of a transition zone built according to the Spanish version of an "embankment after a bridge" construction procedure illustrated in Fig. 11 of the last version (February 2006) of UIC 719R leaflet. The selected civil engineering works correspond to the technical block of abutment n°1 at the Borges Blanques viaduct on the high-speed line Madrid–Barcelona. Shear wave velocities and strain dependent secant Young's moduli higher than 300 m/s and 130 MPa, respectively have been found for the different infrastructure bed layers of this transition zone.

Wheel loads and rail deflections induced by the trains operating the line at 200 to 250 km/h in 2007 and at 250 to 300 km/h in 2008 have been measured at five cross sections over the transition zone (one of them at the interface concrete-ground of the bridge abutment) and at one cross section in the plain track. The behaviour of each cross section zone has been assessed by determining the rail deflections induced in five consecutive sleepers by trains coming out from the bridge and trains entering the bridge using sensors external to the track mounted on the rails (cf section 4.1.3).

#### Increased knowledge, implementable results and related cost reductions

Concerning in situ measuring techniques for determining rail deflections, indirect methods, not requiring the installation of fixed reference bases near the track have been explored. A procedure has been set up to integrate (after having been corrected in the frequency domain) the sig-

nals for bogie trains as measured by tiny 2Hz geophones clamped to the rail base. Further, the feasibility of obtaining wheel load time histories from data provided by a single set of shear strain-gage gridlines attached to the rail web (instead of the two sets normally used) has been evaluated for different types of train. The implementation of those techniques in other measurement campaigns, for assessing track problems in a reliable manner, could represent important cost reductions.

Besides the construction features, train speed and travelling direction seem to be the most influential factors affecting the behaviour of the transition zone analysed in this work. For bogie trains leaving the bridge at 200 to 250 km/h, wheel loads 16% less than the nominal static values have been recorded at both the transition zone and the plain track. At the interface concrete–soil in the edge of the abutment, and for bogie trains travelling at 200 to 300 km/h, higher wheel loads and rail deflections have been recorded for trains entering the bridge than for trains leaving it. At this interface variations in the rail deflections between the stiff side and the soft side of the track ranging between 1:2 and 1:3 depending on train speed, have been found. Although for this particular case it is believed that the most cost effective way to improve the behaviour of the transition zone must rely mainly on the modification of the mechanical behaviour of the track superstructure components, it may be not so for other cases. Whether to act on the superstructure or infrastructure components of the track in a given transition zone case will depend on the nature and magnitude of the problem found.

### Open questions

The indirect procedure set up so far to estimate rail deflections can be further improved by correcting also the amplitude of the signals provided by the 2Hz geophones in the frequency domain. The variations of track stiffness found for the bridge-embankment transition zone analysed in this work should be further confirmed with measurements made in other transition zones of the same type. Reported track measurements can be used to calibrate 3D numerical methods for a complete definition of the most adequate solution to smooth the track stiffness variations found.

### References

1. INNOTRACK Deliverable D2.1.10, Study of variation of vertical stiffness in transition zone, 94 pp (and 10 annexes 7+1+9+1+6+26+31+30+1+9 pp), 2009 [restricted to programme participants]
2. INNOTRACK Deliverable D2.1.11, Methods of track stiffness measurements, 36 pp, 2009
3. UIC leaflet 719R, Earthworks and track bed construction for railway lines, 117 pp, 2008

## 4.1.8 Geophysical methods

Jaroslav Barta, G Impuls

More information is available in deliverables D2.1.5 GL, D2.1.8, D2.1.14, D2.1.15

### Background

Geophysical methods are non-destructive and can provide information concerning the geotechnical conditions of the sub-grade. These methods are environmentally friendly and the results can be translated from geophysical values (for example seismic velocity) to geotechnical parameters (for example modulus of elasticity). The geophysical methods that are principal for geotechnical investigation on tracks are geoelectrical methods (including geological radar), seismic methods and gravimetric methods. Geophysical methods were tested for INNOTRACK in 7 different sites situated in the Czech Republic, Sweden, Spain and France.

### Increased knowledge, implementable results and related cost reductions

A summary of the investigated methods is given in Table 4.1.8-1.

1. Geophysical methods are non-destructive methods that can replace the sporadic network of boreholes, test pits and standard geotechnical tests commonly employed.
2. The geological radar (partly also resistivity profiling) is recommended for primary investigation of long distances (> 1km). The geological antennas are placed on a frame fixed on the measuring railway car. The quick geophysical methods detect geophysical anomalies and indicate the pertinent track segment. The suspicious segments can be recommended for detailed measurements with the use of an optimal geophysical method.
3. The optimal geophysical methods recommended for detailed measurement, are mostly seismic measurement, resistivity tomography and gravimetric

methods. In most cases, two profiles running in parallel with the track are measured. The profiles are close to the track body, but not in the operational zone of vehicles. This allows carrying out the measurement without interrupting the traffic. The geological (geotechnical) information from the rail zone is acquired by seismic tomography, which is executed between the profiles on the sides of the track. Resistivity tomography gives information on the resistivity conditions in the vertical cross section of the profile. Low resistivity is typical of clay, higher resistivity indicates sand or gravel and high resistivity indicates bedrock. Gravity measurement can detect the difference between structures with differing densities.

The geophysical testing in INNOTRACK has proved that geophysical methods can reliably, quickly, in detail and at a relatively low cost, provide information on the geotechnical conditions within the entire measured segment of the track. Systematic application of the geophysical methods within the framework of the complex of geotechnical tests increases the knowledge and helps to identify problematic zones. Well-timed detection of problematic zones and evaluation of their sources results in a cost reduction of railway track maintenance. Long-term monitoring of questionable track segments can further enhance the effect of geophysical measurements. Reliable information on the geotechnical (geophysical) condition of the track body can also help in selecting the optimal technology for subgrade improvements (e.g. by testing different types of improvement techniques).

Investigation method	Range of application (frequencies, distances, types of materials etc.)	Measured parameters	Mechanical parameters obtained	Classification parameters obtained
Geoelectrical	Geological and geotechnical investigations on the track sections from tens of metres to many kilometres. Distances between geophysical sensors mostly from 0.5 metres to 10 metres. Electromagnetic methods work with continuous measurement.	Resistivity [ $\Omega$ m], relative permittivity and additional electrical parameters	Geotechnical interpretation is possible (stiffness, consolidation, compatibility, fracturing)	For example the type of soil. Classification of rock quality. Hydrogeological parameters.
Seismic	Geological and geotechnical investigations on the track sections from 10m to several kilometres. Distances between geophysical sensors mostly from 0.5 m to 10 m.	Velocity [m/s]	Geomechanical interpretation is possible (modulus of elasticity, Poisson coefficient)	Classification of rock quality.
Gravimetric	Geological and geotechnical investigations on the track sections from tens metres to many kilometres. Distances between geophysical sensors mostly from 0.5 metres to 20 metres.	Density [mGal]	Geotechnical interpretations are possible (differential density of geological structures). Indication of caves.	Classification of rock quality.

Table 4.1.8-1: Summary of geophysical methods investigated in INNORACK.

#### Open questions

Detailed research will continue on the relation between different type of seismic waves and the elasticity moduli of soil. It is recommended to continue with the geophysical monitoring measurements that have been carried out on line no 1 near Bechovice (around km 397+500). Relations between quality of the construction layer fortified by lime (2%), climatic conditions and geophysical conditions are currently being investigated. Seismic tomography observes the seismic velocity and time domain reflectometry provides information on the relative permittivity (volume humidity) of the ground (soil). Only long term monitoring (approximately ten years) would allow determination of a correlation between the quality evolution of the lime fortified layer, climatic conditions, geophysical parameters and time.

#### References

1. INNORACK Deliverable D2.1.5, Methodology of geophysical investigation of track defects, 28 pp, 2009
2. INNORACK Deliverable D2.1.8, In-situ measurement database, based on information management framework, 33 pp (and 2 annexes 82+24 pp), 2009 [restricted to programme participants]
3. INNORACK Deliverable D2.1.14, Concluding update of D2.1.8, 30 pp (and 4 annexes 4+13+3+1 pp), 2009 [restricted to programme participants]
4. INNORACK Deliverable D2.1.15, Non-destructive geophysical methods, 17 pp (and 8 annexes, 16+10+13+10+7+7+9+6 pp), 2009 [restricted to programme participants]

## 4.2 Subgrade improvements

To mitigate poor subgrade conditions is very costly. This includes not only the cost of material and work efforts, but also the often extensive traffic disruptions that are caused by the mitigating actions. There is thus a significant cost saving potential in developing new, LCC efficient improvement methods. However these methods need also be thoroughly verified if they are to be employed in large scale use. It is here important that not only the benefits, but also the drawbacks of each method are high-lighted since the methods usually are suited mainly for certain conditions.

INNORACK has investigated, tested and verified a number of improvement methods. These include inclined piling using lime-cement columns, the use of geogrids in transition zones and bad drainage areas, and the use of short vertical soil-cement columns. The methods will be described in this section and benefits and drawbacks outlined.

## 4.2.1 Improvement of a soft embankment area with inclined lime cement columns

Alexander Smekal, Banverket

More information is available in Deliverable D2.2.4, D2.2.5, D2.2.8.

### Background

Many railway lines in the world are in the order of 60 to 100 years old, and not designed in accordance with requirements for modern railway traffic. Due to the future demands for faster and heavier trains, railway sub-structures can experience problems, such as reduced stability, increase of settlements, and the possibility of extensive vibrations. These issues have an adverse effect on the safety, reliability, and economy of the railway operations. Therefore, many existing railways require upgrading before the opening for new traffic conditions. It is always complicated to carry out any remedial work under existing track while not restraining train operations. There are two possibilities: Either close the train operations and remove the track and embankment and perform strengthening, or execute subsoil stabilization without traffic interruption. It is well known that the first described option is very expensive and time consuming. An indication on how the distribution of costs can look like for an actual project finished in Sweden is given in Figure 4.2.1-1.

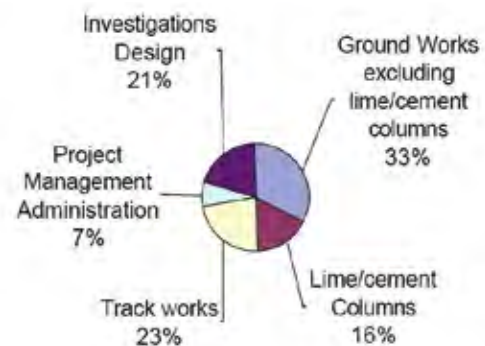

Figure 4.2.1-1: Distribution of the cost for the countermeasure – Lime/cement columns, Sweden

This figure shows the cost distribution for strengthening work. The additional costs due to the fact that the track was closed for train operation over a certain period and the traffic had to be redirected are not included. One can see that the cost for installation of lime/cement columns is only 16% of the total cost. If this is compared with the 56 % that is the cost for ground and track works, it is a very remarkable figure. It is clear that there is a great economical and operational interest to use soil improvements methods that can be used without any, or very little, interference with the existing railway track.

To this end, a new method using inclined lime cement column walls to improve subsoil strength under an existing railway embankment has been tested at full-scale within INNTRACK.

### Test site and geotechnical conditions

The test site (Torp) is located in Sweden. The chosen test site was a critical section for upgrading the line for higher axle load (from 22,5 to 25 tonnes axle load). It had been found that the factor of safety regarding stability for this embankment was too low. Consequently, this railway line could not be upgraded for new traffic conditions before strengthening measures were carried out. This line is made out of two railway tracks with a mixed traffic consisting of freight trains, ordinary passenger trains and high-speed trains. The part that requires stabilisation is about 200 m long and the soil improvement is needed on both sides of the embankment (Figure 4.2.1-2). The full-scale test installations were performed on a stretch of 14 m along the right side of the track. The embankment has a height of



Figure 4.2.1-2: View of double track and embankment at Torp

3 to 4 m above the surrounding ground level. The width of the embankment at the ground level is about 20 m.

The railway embankment runs through a relatively flat area. The upper part of the soil consists of thin organic topsoil followed by very soft organic clay on relatively thick deposits of very soft clay, followed by frictional soil on rock. The relative density of the frictional soil is high (probably moraine). The very soft clay has a thickness of about 15 m. At both sides of the embankment there are pressure berms with a width of about 10 m and a thickness of about 0,5 m to 1.6 m. The pressure berms contain dry crust clay, stones and boulders. The ground water level varies with time and normally reaches up to the ground surface during the wet seasons (winter) and about 2 m below ground level during the dry season (summer).

### Strengthening method and installations of inclined lime cement columns

The stabilized soil is produced by mechanical mixing of a binder and soil with a mixing tool having a nozzle for feeding the binder into the soil. The mixing tool was connected to a rotating Kelly deep stabilisation machine (Figure 4.2.1-3). The production of a column starts with penetration of the rotating shaft and the

mixing tool down to the designed depth. The mixing tool is slowly rotated down to this depth. After this the mixing tool is reversely rotated and lifted while simultaneously a binder is mixed with natural soil. The result is a column of stabilised soil with a circular cross section. The stabilizing process starts immediately and the strength of the stabilized soil increases with time after the installation.

The walls are made of columns installed in a ring of 10 meters diameter, two short test panels with inclined columns and finally ten full-size panels with inclined columns installed under the railway embankment (Figure 4.2.1-4).

### Laboratory and in-situ investigations and monitoring

The following investigations have been performed:

- laboratory tests to investigate the possibility to stabilize the natural soil under the embankment
- in-situ tests in stabilised and natural soil to verify and control the quality of the improvement
- cross hole seismic tomography to control the geometry and homogeneity of strengthening



Figure 4.2.1-3: Installation of inclined lime cement columns under embankment

Monitoring started in June 2008 and finished in March 2009. The more comprehensive monitoring was performed during the installation of the strengthening. The monitoring also included measurements at the time of the western track levelling. The following parameters have been monitored:

- twist of the track
- displacement of the track
- displacement at the surface of the soil at different distances from the track
- distribution of vertical displacement with depth
- distribution of horizontal displacement with depth
- distribution of pore pressure with depth

Excavation of the lime cement strengthening was carried out nine months after the installation to control the geometry and homogeneity of the walls. At the same time samples were taken for laboratory tests to verify the strength of the soil improvement.

#### Increased knowledge implementable results and related cost reductions

The performed full-scale test of subgrade improvement with inclined lime cement column walls under the existing railway embankment without any interference

with full train operations has been successful in all suggested and planned objectives. The work set out with detailed design and planning. Installations under the embankment were carried out under full operational traffic and without any speed or load restrictions. The performed measurements have provided sufficient information about track, embankment and subsoil behaviour before, during and after the installation. The quality of strengthening has been verified by in-situ and laboratory tests. Excavations and laboratory tests executed nine months after installation have confirmed excellent quality of strengthening as regards geometrical form and subsoil improvement of stiffness and strength. The test installations of the inclined columns panels have demonstrated that this method is a feasible alternative for improving the stability of soft subgrade under an existing railway embankment. It has been proved that an installation of the subgrade strengthening can be performed under an operational railway embankment, without any interference with train operations. The measured effects of the ground reinforcement (track uplift, settlements and twist) have been within limits for on-going train operations. No track maintenance was necessary during the installation of the lime cement column

Figure 4.2.1-4: Top: Plan of the installation of columns and column walls (panels) at the Torp

Bottom: Cross section of the strengthening km 193+900

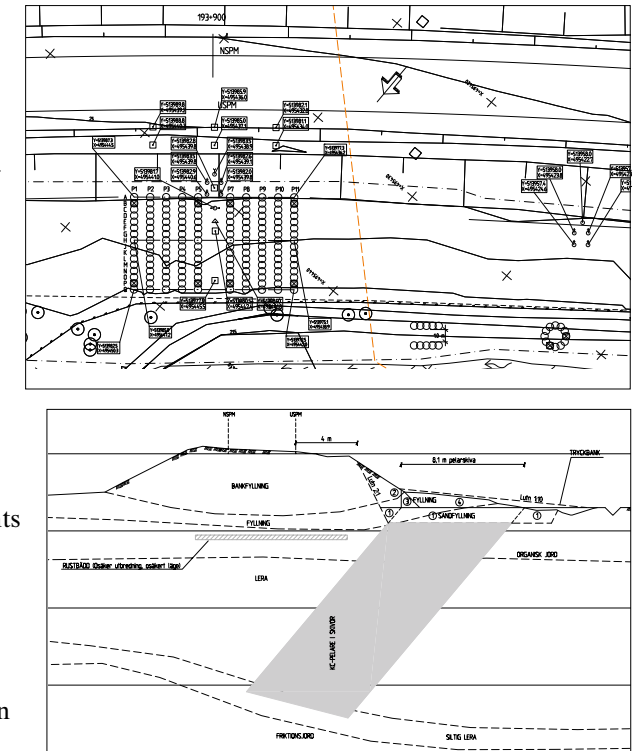

panels. Track levelling was performed after the main settlements ceased, which was more than two months after the strengthening installation. Application of this new method for subsoil strengthening shows clear and significant economical benefits in comparison with currently used traditional ways of soil improvements where track and embankment have to be removed.

#### Open questions

Sometimes a combination of inclined and vertical columns could be favourable. There is always a need to consider the safety precautions and possible restrictions for train speed or axle loads, at the time of installation work. The positioning of the installation equipment is a vital issue and for the future this ought to be further developed, so there are no doubts about the actual geometry of the panel installed in the soil.

At the tests there was a substantial heave directly at installation followed by settlements in the area where the panels were installed, which to a certain extent affected the embankment and the track. Track levelling was performed more than two months after finishing the inclined lime cement installation. For application of this method in a full-scale project, measurements of the track geometry both at the time of

strengthening installation and after are important. Planning of corrective track levelling during and after the installation is recommended. All work with soil stabilization should include laboratory and in-situ tests to verify that assumed design properties match those achieved in the field. All measurements, monitoring, field and laboratory tests have to be carefully planned and it is recommended to include these in a dedicated part of the project design documents.

#### References

1. INNTRACK Deliverable D2.2.4, Description of measurement sites + lcc referenc sites, 57 pp, 2009 [restricted to programme participants]
2. INNTRACK Deliverable D2.2.5, Subgrade reinforcement with columns Part 1 Vertical columns, Part 2 Inclined columns, 122 pp (and 1 annex, 80 pp), 2009
3. INNTRACK Deliverable D2.2.8, Guideline for subgrade reinforcement with columns. Part 1 Vertical columns. Part 2 Inclined columns, 28 pp, 2009

## 4.2.2 Improvement of a transition zone using geogrids

Miguel Rodriguez, ADIF

More information is available in deliverables D2.1.10, D2.2.6 and D2.2.7.

### Background

The current study focuses on strengthening of a section of the conventional Spanish gauge railway between Zaragoza and Lleida, at Montagut. Here a concrete prefabricated block had been inserted, to create an underpass, into an 8 m high old embankment. At the beginning of the study a speed limit of 10 km/h, for both passenger and freight trains existed due to problems in the track requiring frequent tamping operations.

To investigate these problems, a borehole was drilled in the middle of the track and a sliding micrometer was installed. In addition, a high precision levelling campaign of the embankment was carried out and the wheel load and rail deflection time histories induced by a maintenance convoy and the trains operating the line were measured.

As a result of these measurements, the existence of a “seating load” (threshold level around 40 kN below which no load is transmitted through the ballast to the underlying bed layers), indicative of a non-linear poor behaviour of the ballast, was detected. Also, track stiffness values less than 20, 30 and 35 kN/mm were obtained

at one point over the concrete block and at two points over the embankment located at 8 and 45 m from the structure, respectively.

The final solution adopted, see Figure 4.2.2-1, consisted of the improvement of sections 20 to 35 meters long located at both sides of the concrete block. The treatment was achieved by replacing the upper 2.15 meters of the embankment by well-compacted sandy gravel of the QS3 type recommended by UIC. The new material was reinforced with two layers of high elastic modulus geogrid. Further, a geomembrane was installed on the bridge. The old ballast on top of the concrete block and at sections more than 100 meters on both sides of the block was replaced by a 0.35 meter thick layer of high quality ballast.

To compare track stiffness values before and after treatment, a new in situ campaign was undertaken once the installation had been carried out. This time, besides measuring induced wheel loads and rail deflections over the concrete block and over the embankment, at distances of 10 and 40 meters from the structure, the behaviour near the concrete block of one transition zone was also investigated. To that aim, optical laser

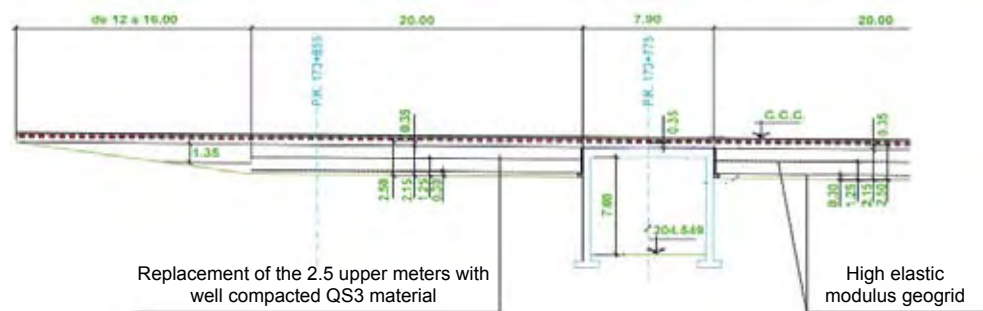

Figure 4.2.2-1: Final solution adopted to improve transition zones at Montagut

systems were installed between two consecutive sleepers at both sides of one of the two concrete-soil interfaces of the structure. In addition rail-sleeper load cells were attached to these sleepers.

### Increased knowledge, implementable results and related cost reductions

The geotechnical investigation carried out in this case turned out to be crucial for solving the existing track problem. The data provided by the sliding micrometer, corroborated by the high precision levelling campaign, has eradicated the poor behaviour of both the core and the foundation of the embankment. On the other hand, the poor mechanical behaviour of the ballast, observed in the passages of the maintenance convoy, was associated to the excessive thickness of that layer (up to 0.9 m at some points). This was a result of the frequent tamping operations required to keep the line operative. In addition, the upper bed layer of the embankment was in a bad state (having small pieces of coal mixed with a red brown clay, as observed in the continuous core retrieved from the borehole). These factors were identified as the main causes of the problem.

To overcome the 10 km/h speed limitation, a project had initially been prepared based on the improvement of the embankment core at both sides of the concrete block, without interrupting the railway traffic, by injecting stable mixtures of cement with inclined “tubes à manchettes” from a side berm previously placed against the embankment. This solution, successively employed for the improvement of a transition zone at the Amposta viaduct over the Ebro river in Spain (see the SUPERTRACK project finalised in 2005 for the 5th Framework Programme of the European Commission), was discarded after checking that both the embankment core and its foundation were behaving properly at Montagut. Based on this, the solution described above was employed. Note that the adopted solution is much more cost effective.

After treatment, track stiffness values are 2.5 to 4 times higher and no “seating load” is detected in the ballast. Post-treatment track stiffness magnitudes 2 to 3 times the original have been found in a zone at 40 to 45 meters from the concrete block, where only the superstructure of the track has been replaced. That improvement is only 20% to 25% less efficient than what was achieved in the transition zones where a more complete treatment (affecting also the upper layer of the embankment) was carried out. This stresses the importance of first eradicating the poor behaviour of the infrastructure before implementing solutions based solely on the improvement of the track superstructure.

In the first track stiffness measurement campaign carried out in Montagut one of the two shear strain gauge sets attached to the rail web in the middle of a track span failed. To aid in the determination of wheel load time histories in such situations a methodology has been set up. It allows estimating the loads induced by the trains from the differences of the two peaks of the shear force measured in a given cross section with only one shear strain gauge set. Not needing to come back to the track for repairing a faulty system represented in this case a significant saving in the cost of the works carried out to assess the magnitude of the problem.

The solution finally adopted has proven to be very efficient. It took only six days to carry out the reparation works. Since the implementation, in the summer of 2008, no maintenance problems have been reported from the passages of track inspection cars over the site. After the retrofitting campaign, the operation on the line was resumed with a maximum allowed operation speed of 160 km/h. Besides the increase in safety, the possibility of operating the line at speeds higher than 10 km/h has meant an important time saving for both freight and passenger trains. The elimination of the frequent ballast tamping also represents a substantial reduction in its maintenance cost.

### Open questions

A loss in track stiffness of 30% was still detected, after the treatment, when analysing the pass of maintenance and commercial trains from the underpass concrete block to one of its transition zones. After checking the opposite transition zone, it would be worth investigating this problem keeping in mind the construction procedure adopted when implementing the repair works. To that aim, the information provided by the rail-sleeper load-cells at the concrete-soil interface of the underpass structure should be of great help. To complete the analysis, the loading data and rail deflections provided in this work should be interpreted using a properly calibrated 3D numerical model.

### References

1. INNOTRACK Deliverable D2.1.10, Study of variation of vertical stiffness in transition zone, 94 pp (and 10 annexes 7+1+9+1+6+26+31+30+1+9 pp), 2009 [restricted to programme participants]
2. INNOTRACK Deliverable D2.2.6, Guideline for subgrade reinforcement with geosynthetics. Part 1: Enhancement of track using under-ballast geosynthetics. Part 2: Improvement of transition zones on conventional lines, 46 pp, 2009
3. INNOTRACK Deliverable D2.2.7, Substructure improvement of a transition zone on a conventional rail line, 68 pp (and 2 annexes, 8+15 pp), 2009 [restricted to programme participants]

## 4.2.3 Soil improvement of a bad drainage zone using geogrid

Petr Jasansky, SZDC

More information is available in Deliverables D2.2.1, D2.2.6

### Background

An experimental programme has been carried out to improve a bad drainage zone using geogrid in the Czech Republic. The first test section (Figure 4.2.3-1) is situated in a shallow cut. The neighbouring field is sloping towards the track and as no drainage is employed on the cut edge, in practice the cut behaves like a ditch. The second test section (Figure 4.2.3-2) is situated at a railway station.

### Range of repair works

For the first test section, track drainage has been achieved by a complete cleaning of the existing longitudinal ditches and the installation of a subdrain trench lined with geotextile on both sides. For ballast cleaning, a ballast cleaner machine sc600 has been used. It has also been decided to use it for geocomposite installation. The second test section was mitigated by the technology of rail, sleeper and ballast removal.

### Selection and installation of a geocomposite

In the first test section, the installation of a

geogrid appeared to not be a sufficient solution since it was not certain that the longitudinal drainage reparation would solve the problem for all problematic places along the cut. On the other hand, geotextile would be a protection against infiltration of fine particles from the subgrade. The geocomposite installation was carried out at the same time as the old ballast was excavated (Figure 4.2.3-3). Geocomposite unpacking under the machine made it difficult to keep the roll in place.

On the second test section, two kinds of geosynthetics were used (Figure 4.2.3-4). These were spread out on the modified surface after removal of the old ballast.

### Increased knowledge implementable results and related cost reductions

Dynamic and static plate load tests on subgrade and on ballast before and throughout the installation of geocomposite have been carried out on both test sections to determinate the subgrade characteristics. Further, soil samples have been collected



Figure 4.2.3-1: Track with drainage defects before reparation



Figure 4.2.3-2: Station track with clear drainage defects



for laboratory tests. These load tests have been repeated regularly. Results demonstrate subgrade consolidation before installation and no full ballast consolidation through the time of observation.

Laboratory tests from the collected samples of the first test section show a subgrade made of brown clay soil with low plasticity. This implies the risk of dangerous frost heaving and waterproof soil. Muddy subgrade soil penetrated through the geotextile after 6 months and created a paste layer (about 2 cm) in the bottom of the ballast. It shows that drainage repa- ration improved line condition, but not sufficiently. Consequently, not all subgrade problems were successfully solved.

This solution has the potential for cost reductions due to the decreased need of track geometry maintenance (tamping, ballast refilling, etc.).

#### Open questions

In order to draw final conclusions, the observation time has so far been too short. Further, a wider range of measurements is likely to be needed. The first method chosen for placing the geocomposite is problematic and limited by the practicality of the machine; the second method is suitable and enables a superior geogrid installation.



Figure 4.2.3-3: Old ballast removal with geocomposite installation

Ballast reinforcement by geogrid is not technologically difficult and it is not expensive in comparison to other maintenance costs. However, it is important to have knowledge on when this method is effective. Consequently, a technical and conditional assessment needs to be made based on an analysis of test section results and further experience.

#### References

1. INNOTRACK Deliverable D2.2.1, State of the art report on soil improvement methods and experience, 35 pp (and 2 annexes, 16+3 pp), 2008
2. INNOTRACK Deliverable D2.2.6, Guideline for subgrade reinforcement with geosynthetics. Part 1: Enhancement of track using under-ballast geosynthetics. Part 2: Improvement of transition zones on conventional lines, 46 pp, 2009

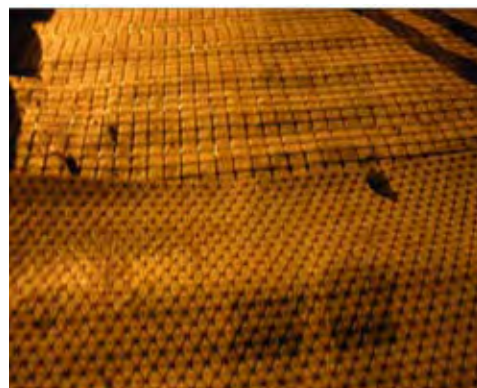

Figure 4.2.3-4: Two kinds of geocomposites after installation

## 4.2.4 Feasibility of a ground reinforcement technique using vertical soil-cement columns

Emmanuel Bourgeois, LCPC

More information is available in deliverables D2.2.5 and D2.2.8

#### Background

An experimental programme was carried out to check the feasibility of a ground reinforcement technique consisting of building vertical soil-cement columns below an existing railway platform without removing the track. The columns are built using the wet deep-mixing method. Specially designed expandable tools make it possible to build columns in the subgrade layer below the platform.

Some columns have been built on a site of Northern France provided by SNCF. The technique worked well in the grounds of the site (mainly silt and chalk). Some columns were built under an existing sidetrack. Vertical deflections induced by the weight of a maintenance train were measured in areas reinforced with 1 and 5 columns. Other columns, built close to (but not directly under) the track, were subjected to static vertical load tests, for loads close to failure.

Numerical simulations of the static load tests were performed to obtain the values of ground parameters giving the best agreement between field tests and computations. This back analysis provided parameters that were used for three-dimensional analysis of the behaviour of a track resting on a subgrade layer reinforced by vertical soil-cement columns. The analysis of results focused on vertical deflection of the track when a (static) load corresponding to the axle load is applied to the rails. It shows how the reduction of vertical deflection depends on the amount, the diameter and the spacing of columns. In the analysis, one must also check that the load carried by the columns is much lower than their limit load.

#### Increased knowledge implementable results and related cost reductions

In practice, the technique and tools used were well adapted to the ground of the experimental site. In addition, numerical simulations showed that the reduction in deflection attributed to the columns is relatively small. Since soil-cement columns are not as stiff as concrete or steel inclusions the deflection is relatively homogeneous in the reinforced zone. This reduces the risk of creating “stiff points” which may induce vehicle vibrations and ballast wear. Numerical results also indicate that two rows of columns outside the rails provide a deflection reduction close to that obtained with three column rows, so that the central row of columns (more difficult to build since it is placed between the rails and in-between sleepers) may not be necessary. Additional numerical simulations could help choosing the most efficient pattern (diameter and spacing between columns).

The potential cost reduction obtained by this technique is significant as it makes it possible to reduce maintenance, and to postpone heavy remedial works.

#### Open questions

The experimental programme was mainly meant to show the feasibility of the technique. It did not make it possible to deal with design optimization. In addition, results remain to be confirmed by similar tests on other sites with different ground conditions.

#### References

1. INNOTRACK Deliverable D2.2.5, Subgrade reinforcement with columns Part 1 Vertical columns, Part 2 Inclined columns, 122 pp (and 1 annex, 80 pp), 2009
2. INNOTRACK Deliverable D2.2.8, Guideline for subgrade reinforcement with columns. Part 1 Vertical columns. Part 2 Inclined columns, 28 pp, 2009

## 4.3 Superstructure optimisation

In INNOTRACK two novel superstructure solutions have been developed and tested. These are the Two Layer Steel Track and the Embedded Rail Slab Track. The Two Layer Steel Track provides a fast installation and a low surface pressure. The solution is targeted towards switches & crossings. The Embedded Rail Slab Track is an optimized innovative slab track solution that provides verified LCC savings for heavy duty conditions. The Embedded

Rail Slab Track features a fastening free system, an innovative rail profile that is installed with a sealed pad and a glass fibre reinforced plastic composite shell.

Numerical simulations have played a key roll in the development and verification of these innovative solutions. This has advanced the general use of such simulations and in particular the integration of simulations in the design process.

### 4.3.1 A new slab track design: the Two Layer Steel Track

Dave Farrington, Corus

Additional information is available in deliverables D 2.3.1, D 2.3.2, D2.3.5.

#### Background

Ballasted track provides a cushioned support to the sleeper/rail system; however the movement this requires is also responsible for the degradation of ballast leading eventually to poor track quality and a need for maintenance using tamping machines and ballast cleaners. To avoid this designs of slab track have been developed over many years, but have not succeeded in replacing significant proportions of ballasted track. These long standing versions of concrete slab track are relatively thick layers, with or without the steel reinforcement typical of concrete building or bridge structures. Because of the impossibility of correcting for ground movement, they are built on ground which has been excavated and replaced with “improved” soil and more expensive combinations of fill which can include cementitious material to give added strength, resistance to water ingress and frost protection.



Figure 4.3.1-1: Pre-assembled panel lowered onto the formation

INNOTRACK has included development of a new 2-layer track form, shown in Figure 4.3.1-1, which is completely different to previous systems. The work included development of new concepts of track design taking into account normal railway and engineering requirements, but at the same time achieving a low maintenance design of a track, which can be installed rapidly. The design was optimised using finite element analysis, tested for fatigue and evaluated for environmental impact. New methods of installation were trialled and a demonstration track form was installed in the UK.

#### Increased knowledge implementable results and related cost reductions

The key findings and features of the new 2-layer track form system are:

1) Pressure on the formation is reduced by the use of a stiff frame supported on a load-spreading platform. Figure 4.3.1-2 compares the pressure under the developed Corus track with a ballasted track.

The system is intended for use on existing tracks – zones of high stress in the first half metre below the sleepers will be partially removed, to be replaced by the base layer (concrete encased steel members) with a layer of bedding material beneath. The original material in the formation will then be subjected to lower operating stresses than it has previously experienced under the loaded zones, leading to a much longer life without further plastic deformation.

2) The Two Layer Steel Track system is designed to be pre-assembled in panels, including fastenings and transported by rail to site. This method of installation is adopted to speed up the installation process.

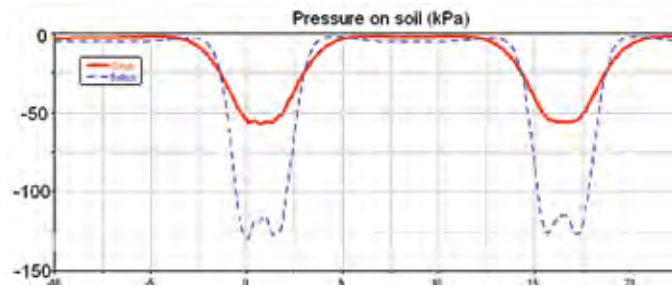

Figure 4.3.1-2 Pressure distribution under 25 tonne freight vehicle

3) The upper steel frame on which the rails are mounted can transmit loads directly to the formation independently of the base during the period of concrete curing. This means the track can be opened to traffic without delay, and concreting carried out at a more convenient stoppage.

The Gantt charts in Figure 4.3.1-4 for operation on adjacent lines shows the effect this has on the productivity of the line. This is an example for a crossover installation using modular (panel) systems in both cases.

4) The frame and base can be adjusted relative to each other both at installation and if there are later changes of the formation e.g. due to subsidence or severe flooding. Figure 4.3.1-5 shows the main elements of the structure without baseplates. The grey longitudinal members and the blue cross members are a steel frame, which can be jacked up separately from the concrete slab.

5) The inherent bridging capability of the steel frame structure enables the system to tolerate major problems of the formation should they occur.

6) Environmental impact: For higher speed trains it was found that the additional noise expected from slab track was attenuated by the behaviour of heavy baseplates, which act as tuned absorbers for parts of the frequency spectrum. Further aspects of the design mean that inclusion of damping and noise-absorbing materials will be particularly effective if required.

Ground vibration benefits were measured on the demonstration track installation at Scunthorpe UK. Figure 4.3.1-6 shows the new track values (red) compared with ballasted track (blue) at 3 m from the track. There is considerable reduction (10 to 25 dB) between 10 Hz and nearly 200 Hz.

The system has an initial cost, which is higher than a ballasted track. However, it can significantly extend track life without



Figure 4.3.1-3: The steel frame in position prior to concreting

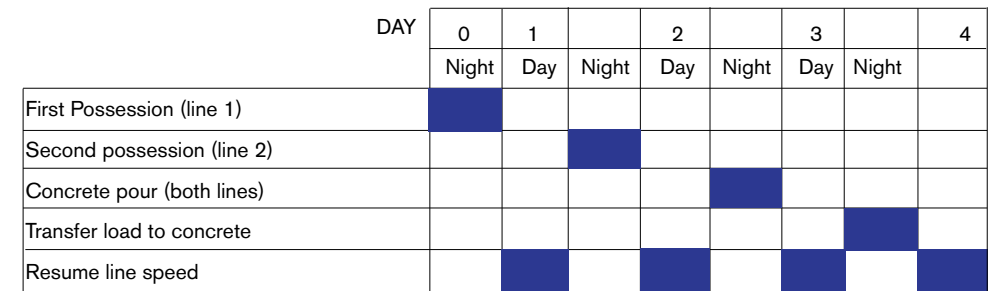

Figure 4.3.1-4: Gantt chart showing night possession plan

requiring enhanced installation time. This advantage distinguishes it from a conventional slab track. The level of cost does not justify use in plain line where there are no formation problems to solve. For critical track segments where gaining possession time for both renewal and maintenance is difficult there are potentially significant benefits.

A typical s&c design has modifications to the frame to account for the rail positions and the crossing components. The system can be based on a layout of bearers similar to a conventional s&c. It can provide preferential support in critical areas, accommodate particular baseplate designs, and be divided into panels of suitable size for single line working.

It is estimated that the cost of using this more permanent form of track for s&c would result in increased materials costs of approximately 10–15% of the total project cost, based on average data across a wide range of projects. In addition to the benefits of slab track, this would be offset by logistics advantages (converting from traditional to panel based methods) particularly for highly trafficked complex layouts and the possibility of hand back at line speed.

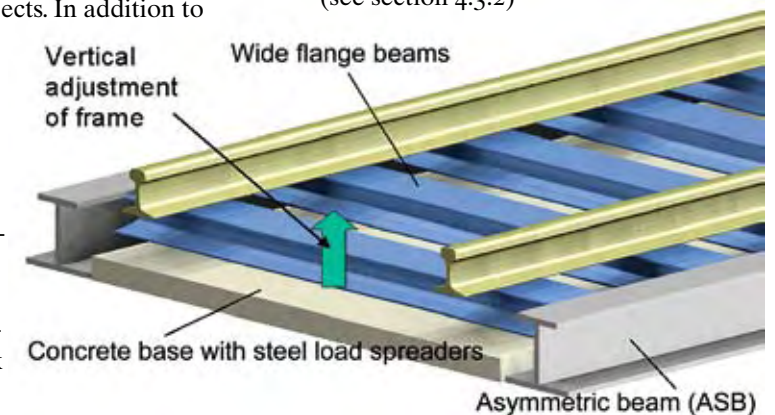

Figure 4.3.1-5: Isometric view of two layer steel slab system

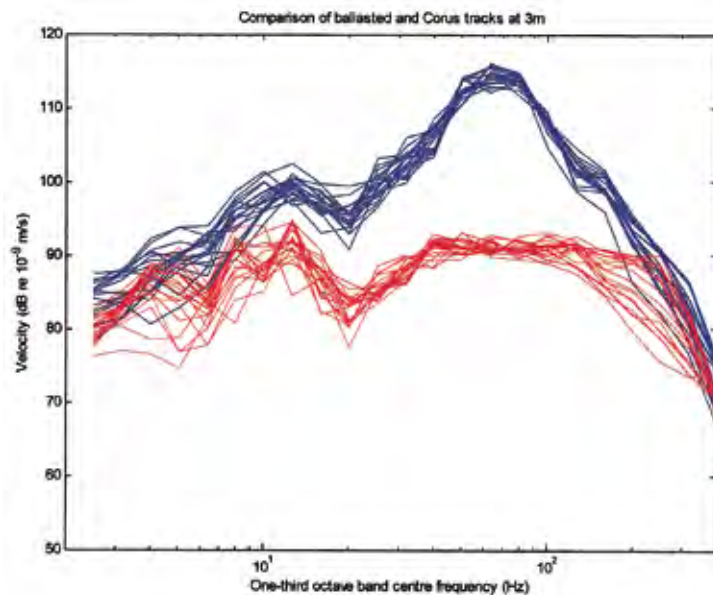

Figure 4.3.1-6: Ground vibration measured on the demonstration track

4. Improvement of poor formation/instability. If the system is being considered in comparison with other methods of track repair to solve formation problems, the best technical solution has to be determined from the specific circumstances and problem to be tackled.

#### Open questions

It is stressed that individual applications have to be assessed against a wide range of local parameters. These will include for example track duty, speed, vehicle type & loading, cost of unavailability, s&c type and design, number of tracks, access.

#### References

1. INNTRACK Deliverable D2.3.1, Validation methodology and criteria for the evaluation of frame type, unballasted or slab-track based superstructure innovations, 12 pp, 2008
2. INNTRACK Deliverable D2.3.2, Optimised design of steel-concrete-steel track form, 56 pp (and 6 annexes, 4+5+1+2+1+2 pp), 2008 [restricted to programme participants]
3. INNTRACK Deliverable D2.3.5, A novel two-layer steel-concrete trackform for low maintenance s&c, 24 pp (and 1 annex, 13 pp), 2009

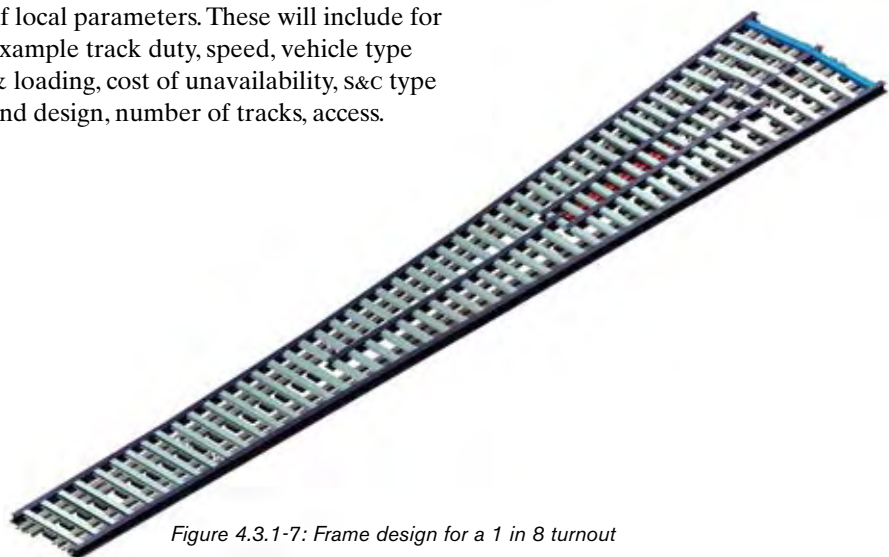

Figure 4.3.1-7: Frame design for a 1 in 8 turnout

## 4.3.2 Embedded Rail Slab Track

Charles Penny, Balfour Beatty

More information is available in deliverables D2.3.3, D2.3.4, D2.3.6.

#### Background

The fundamental task of INNTRACK is the endeavour to deliver track infrastructure at a life cycle cost (LCC) 30% less than currently available in the marketplace with improved safety, capacity and environmental impact.

It has been demonstrated that the essential elements of such a solution now exist in the form of the Balfour Beatty Embedded Rail System (BB ERS). An existing concept has been analysed and the design modified to deliver low manufacturing and installation costs. The optimised components have been validated through comprehensive rail fastening tests. The solution has been developed from proven engineering principles to be simpler, easier, quicker and cheaper both to manufacture and to install.

A site to demonstrate the BB ERS for Inntrack has been identified at Waghäusel by Deutsche Bahn.

#### Cost effective manufacture

Each component has been optimised for its performance and its ease, speed and economy of manufacture. The efficient design and small number of parts that make up the sub-system means that a very low maintenance track form is achieved. The

continuously supported rail provides an optimum, reliable and repeatable wheel/rail interaction.

No fastenings are required for the embedded rail system. The track quality/cost performance is improved over other high performance systems by overcoming the problem of clamping a rail directly onto a concrete support. The rail shape and embedment are also effective in reducing noise. The high railhead stability allows a softer rail pad to be used. This in turn leads to a reduction in rail corrugation, vibration, and impact forces.

The Balfour Beatty BB14072 rail is a new rolled profile with a non-traditional rail shape but a head surface geometry identical to that of the CEN 60 rail. The rail has been designed, in combination with the rail pad, to maintain the live load stress range in accordance with fatigue strength requirements. Uniquely, the entire rail section of BB14072 can be ultrasonically tested from the railhead. As many rail-breaks initiate from ultrasonically undetectable defects, i.e. in the rail foot, the system is significantly safer than flat bottom rail sections. The rail height provides up to 100% increase in available headwear.



Figure 4.3.2-1: UK installation of BB ERS system (Waghäusel site)

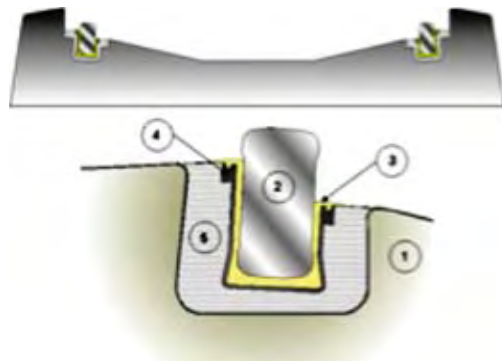

Figure 4.3.2-2: Cross section of BB ERS system

The pad is made from high quality closed cell micro cellular polyurethane, formed by a precision injection moulding process. By changing the density of the injected material, the stiffness of the rail system can be varied over a wide range. The pad design also features an integrated seal that prevents the ingress of moisture and contaminants into the system. This seal locks into the underlying shell and is inclined such that water and debris drain away from the rail.

The shell is a Glass Fiber Reinforced Plastic (GRP) composite. A good quality chemical-resistant grade resin has been used to ensure that the glass fibre component is protected from the alkaline concrete environment. The main function of the shell is to form a dimensionally accurate slot, to constrain the rail and to ensure the correct performance of the elastomeric rail supports. The shell provides secure support to the elastomeric pads and transmits the live loads, vertical, longitudinal and transverse, from the train through to the surrounding concrete.

The manufacturing tolerances, speed of production, quality, and costs were all validated and input into an Life Cycle Cost model.

#### Cost effective Installation

An embedded rail solution offers flexibility in terms of construction options. Consequently, the engineer is not constrained by the limitations of other slab or ballasted

track construction methodologies and plant. This approach has the potential to significantly reduce the cost of track installation compared to ballasted track or other slab track systems.

The typical construction height of embedded rail track is less than alternative options. For example, ballasted track from top of rail to bottom of ballast is in the order of 600 mm. The embedded rail system can be half of this. The effect of embedding the rail is an increase in capacity and a contribution to the low LCC.

The advantage of a continuously supported embedded rail system such as the BB ERS is that it allows an efficient structural beam to be engineered for the structural support of the tracks. The possibility of making this beam pre-cast, slip-formed or even in-situ poured using pumped concrete maximises the opportunity for the construction process to be optimised with respect to constraints regarding time, space, traffic and available railway construction and renewal resources.

The shell has been designed to allow a lid to be “clipped” onto it. The clipped lid shares the same geometry and position of the running rail, therefore allowing the shell to be accurately placed, lined, levelled and gauged to the final rail alignment prior to grouting into position. It is effectively a light temporary dummy rail. This introduces flexibility into the installation process. The normal dependency of simultaneous concreting, aligning and railing is broken. These tasks can be undertaken independently allowing the maximum use of standard low cost, high output equipment e.g. concrete slip formers and road-rail vehicles. The lid has been designed with lugs to allow for automation and ease of handling.

The embedded rail system facilitates a “top down” construction methodology. The main advantage of this method is that it separates civil engineering tolerances (generally +/- 10mm) from mechanical tolerances (+/- 1.0mm). In addition, by elimi-

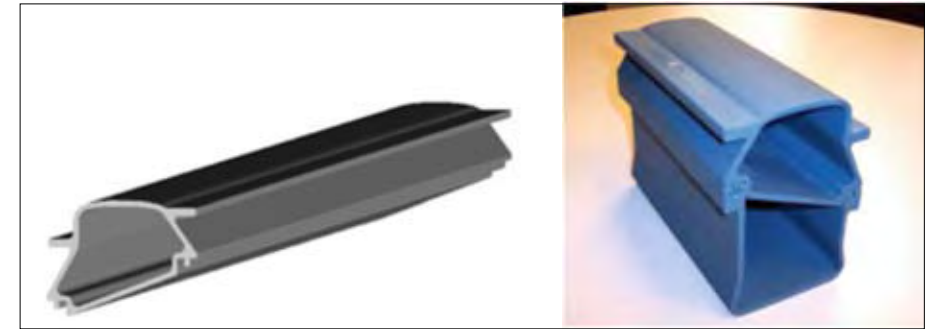

Figure 4.3.2-3: BB ERS Clipped Lid

nating the risk of holding the rail during the concreting phase, it allows rail alignment to be set accurately from and against a solid working surface.

The BB ERS system avoids the typical slab track construction complexity implicit in the need to provide support to sleepers, slab or rails while concrete is cast. The temporary works for pouring and vibrating concrete whilst maintaining tolerances, not least during changes in ambient temperature, is an onerous task that this embedded rail system has eliminated. The significant problem of protecting the fastenings from wet concrete is also eliminated.

#### Testing & approvals

All testing work has been in compliance, where meaningful, with current European Standards EN 13146 and EN 13481. The standards are based on discretely supported systems and so the clamping force test was modified slightly to keep as close as possible to the original intent of the EN.

A full suite of tests in accordance with EN 13481-5 (clamping force, longitudinal rail restraint and vertical stiffness), were completed on BB ERS test pieces. The sub-system was then subjected to a repeat load test at the Technical University of Munich to simulate in-service railway loads and stresses. EN 13481-5:2002 stipulates the maximum deviation between the initial and final static test suites to be:

- Clamping force – maximum change < 20%
- Longitudinal rail restraint – maximum change < 20%
- Vertical stiffness – maximum change < 25%

As seen in Table 4.3.2-1, the test samples have exceeded the requirements specified in the referenced European Standards, proving that the BB ERS system works under stringent test conditions. In addition, the maximum changes between initial and final tests were all within the limits defined by the Euronorm for slabtrack fastening systems.

Test Results for the Balfour Beatty Embedded Rail System			
Test	Initial testing	Post-repeat loading	% Change
Clamping force	5.9 kN/650mm	5.8 kN/650mm	2% decrease
Longitudinal rail restraint	11.1 kN/650mm	10.1 kN/650mm	11% decrease
Vertical stiffness	25.7 kN/mm/650mm	30.8 kN/mm/650mm	20% increase

Figure 4.3.2-1 Comparison of average test results for the BBERS

## Conclusion

The objective of the technical developments has been to save cost. The use of the clipped lid has eliminated construction dependencies that would otherwise require simultaneous concreting, alignment and railing.

As demonstrated in the testing, further savings will arise due to the positional independence and stability of each rail and the track quality retention.

The costs of installing, maintaining and operating this system have been independently verified in an LCC analysis (see section 4.4). The conclusion is that, if adopted, the system would have an installation cost close to that of a ballasted track and would return savings rising to 30% and above after a threshold gross tonnage.

## Open question

Although the system has been approved for use in the UK, the installation of the demonstration Embedded Rail Slab Track section in Germany will be a good opportunity to monitor and verify all the conclusions drawn by the simulations and the tests done independently on each component. It will also be the occasion to verify the long-term behaviour. It will enable study of how the track performs under repeated track loads and environment and climatic conditions, including the sub-grade impact on the track, mechanically and with time.

It will also be an opportunity to confirm the low level of maintenance required and to verify the LCC calculations and the positive savings / results presented with this technology.

Due to the low profile and flexibility of the system, other potential savings exist in the engineering structures, e.g. lighter structures, reduced tunnel diameters, or increased capacity. They are however outside the scope of the INNOTRACK studies.

## References

1. INNOTRACK Deliverable D2.3.3, Design and manufacture of embedded rail slab track components, 32 pp, 2008
2. INNOTRACK Deliverable D2.3.4, Testing of the innovative BB ERS trackform, 40 pp (and 3 annexes, 22+15+1 pp), 2009
3. INNOTRACK Deliverable D2.3.6, Selection of a railway track system by best value analysis, 8 pp (and 2 annexes 3+6 pp), 2009

## 4.3.3 Developments in numerical simulations of superstructures

Chris Jones, Southampton University and Yann Bezin, Manchester Metropolitan University

The development of the innovative superstructure solutions in INNOTRACK raised a need also for a development in numerical simulations to design and validate these optimised solutions.

The Institute of Sound & Vibration Research (ISVR) have carried out predictions of noise levels, ground vibration and roughness growth. Vibration measurements on the demonstration track were used by ISVR to model noise radiation under normal traffic. These simulations showed that the steel frame employed in the Two Layer Steel Track (see section 4.3.1) does not contribute to the noise, due to the damping of the resilient pads used. In addition to standard methods available from ISVR, new software for roughness growth evaluation was developed as part of a PhD thesis by B Croft. The modal forms of the equations of motion for the track, vehicle and their interaction are solved as a state space system using a time-stepping routine with variable step size. The interaction forces between the wheels and the rail are determined as the wheels move along the model of the track. This takes into account the filtering effect of the contact patch. The research showed that differences between ballasted track and this design of slab track with discrete resiliently supported baseplates were not significant. Stiff pads on ballasted tracks are worse, but by and large the effects are dominated by vehicle type.

Manchester Metropolitan University has been using a combination of Multi-body System (MBS) and Finite Element Method (FEM) to model the dynamic interaction of a railway vehicle with various track forms. The innovation of the modelling techniques employed consist in using

conventional railway vehicle dynamics tools to build advanced and detailed flexible track models that can interact with complex vehicle models and non-linear wheel-rail contact algorithms. The two innovative track superstructure solutions proposed (the Two Layer Steel Track and the Embedded Rail Slab Track) were thus compared with conventional ballasted track and their behaviour assessed under various loading conditions. Advantages were demonstrated by highlighting their capabilities to better distribute the loads from the vehicle to the supporting ground structure, thus significantly reducing the level of forces and pressure onto the track and also reducing the risk for high impact and damaging forces on both sides of the system: the vehicles and track.

## References

1. INNOTRACK Deliverable D2.3.1, Validation methodology and criteria for the evaluation of frame type, unballasted or slab-track based superstructure innovations, 12 pp, 2008
2. INNOTRACK Deliverable D2.3.2, Optimised design of steel-concrete-steel track form, 56 pp (and 6 annexes, 4+5+1+2+1+2 pp), 2008
3. INNOTRACK Deliverable D2.3.3, Design and manufacture of embedded rail slab track components, 32 pp, 2008
4. INNOTRACK Deliverable D2.3.4, Testing of the innovative BB ERS trackform, 39 pp (and 3 annexes, 22+15+1 pp), 2009
5. INNOTRACK Deliverable D2.3.5, Two-layer steel:concrete track, 26 pp (and 1 annex, 13 pp), 2009

## 4.4 LCC savings and logistics improvements for substructure and superstructure

Wali Nawabi, DB

More information is available in deliverables D2.2.4, D2.2.5, D2.2.7, D2.3.3, D2.3.4, D2.3.5, D2.3.6, D5.3.1, D5.3.2, D6.5.1 and D6.5.3

### Background

The main objective of INNOTRACK is to reduce Life Cycle Costs (LCC) by about 30%. The aims regarding track support and superstructure are defined in line with the demands of the entire INNOTRACK project. These are to develop new cost effective track systems and maintenance procedures to improve the current, extremely expensive, enhancements of subgrade and superstructure linked with corrective maintenance.

The technical assessments and innovations have been assessed in economic terms. To verify the economic impact of the innovations and to prove the LCC benefits are very important for the success of the project and in ensuring implementation of the developed innovations.

### LCC calculations for reinforced sites

To assess LCC, information on some investigated sites has been gathered. These sites were selected due to existing maintenance problems and with regard to the different results obtained in the frame of INNOTRACK. The selected sites are used as reference systems for the LCC calculations: Based on the description of the sites, reference models have been established. The analysis of the optimized solutions refers to these reference models. The framework for the technical and economical analysis is a template, which was developed in INNOTRACK. This template helps to gather all relevant LCC information and data on the selected sites and details the characteristics of the sites (track elements, track condition, boundary conditions, encountered problems on the site etc.).

Regarding subgrade improvement methods reference systems were established corresponding to these three zones for the LCC calculations:

- Low bearing zone (France)
- Soil strengthening under existing railway embankment (Sweden)
- Transition zone (Spain)

#### Low bearing zone (France)

The reference track is a double track section located in Chambéry-Montmélian (France). The section is a ballasted track of 7 kilometres length inside the Alps, with mixed traffic and a constant tonnage of 14 MGT/year.

Huge maintenance activities and repeated track levelling needed to be undertaken due to subsoil problems.

In addition, this site has been investigated by all the tools and methods studied in the frame of INNOTRACK, which helped in the definition of the reference case. This reference case can consequently be well characterised in the template.

Renewal of the superstructure had not the expected effects since the problem remained. The maintenance experts found out that the track could be improved by doing a subsoil improvement in order to solve the encountered problem on this site. As no measurement tools have previously been used, the subsoil problems couldn't be identified at an early stage, i.e. before renewal of superstructure. The subsoil problem was then solved by a special drainage construction.

The LCC calculation consists in the comparison of the reference system, without drainage linked with huge maintenance

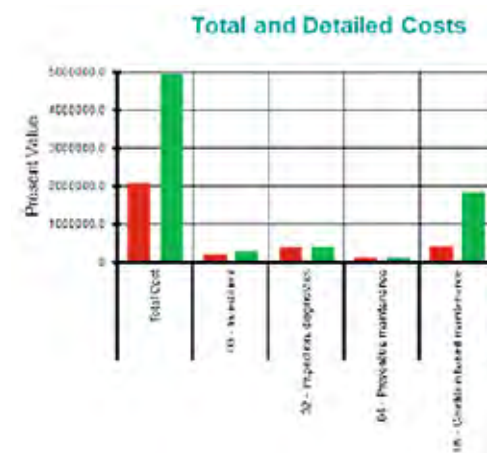

Figure 4.4-1: Total costs of reference and optimised system for the low bearing reference site.

costs and the optimised system with a drainage construction. The costs of installing, maintaining and operating this system have been modelled in the software D-LCC. The LCC model includes all necessary track components and the LCC input data for ballasted track have been verified. The evaluation of the solution in terms of LCC has demonstrated that the optimised system is not just the best technical solution but also proven benefits in economic terms, as shown in Figure 4.4-1. Without the drainage solution, the cost over a life cycle of 40 years would be more than double mainly due to the annual maintenance costs.

#### Soil strengthening under existing railway embankment (Sweden)

For this case there is no description or definition of the reference case containing all the relevant LCC input data (boundary conditions, maintenance activities and related costs etc.) to be compared with the innovation of the inclined lime cement columns.

The detailed definition of the optimised system including the boundary conditions and requirements is already described in section 4.2.1.

The LCC calculation requires a comparison between the reference and the optimised system. In the optimised system

the substructure reinforcement has been carried out under the existing track without track excavation and without traffic disturbances. A reference system has not been defined, but is required for comparison in the economic evaluation. Therefore, the reference system for the case of soil improvement has been taken as an excavation of the whole track for ground and track works including catenaries.

Regarding the optimised system the costs for investigations and design were 21% of the total costs and the installation of the lime cement columns 16%. For the reference system there are 56% of additional costs due to the excavation of the whole track for ground and track works in order to perform the reinforcement.

In this context there are three important aspects:

1. The total cost of the innovative solution was low compared to other methods.
2. The costs for lime cement columns were only 16% of the total costs.
3. No additional costs due to traffic disturbances have been taken into consideration since the remedial work was carried out under the existing track and without restrictions to train operation. It is obvious that there is a great economical and operational interest in using soil improvements methods that are without any, or with very little, interference on the existing railway track.

In this case, the innovative solution is easy to argue for from an economic point of view, since the benefit of this optimised solution is obvious. Because the results were clear and the model simple enough, it was decided that there is no need for LCC calculations. In order to do a full LCC evaluation it is necessary to define a reference case containing detailed LCC input data (especially maintenance activities and related costs) to be compared with the innovation of the inclined lime cement columns. The following approaches were suggested:

- To find another track in Sweden with almost the same boundary conditions and soil problems where sufficient (maintenance) cost data is available
- An alternative case could be defined evaluating what would have happened if the track would not have been strengthened and instead just maintained. That means that maintenance activities (e. g. measurements, monitoring, special retrofitting measures etc) and related costs for these activities have to be defined.

#### Transition zone (Spain)

There is no definition of a reference case containing all the relevant LCC input data (boundary conditions, maintenance activities and related costs etc.) to be compared with the innovative solution for the transition zone.

The detailed definition of the optimised system with the boundary conditions and requirements is described in section 4.2.2. The solution consists of an improvement of 32 meters of the embankment at both sides of the concrete slab by replacing the material 2.5 meters below the bottom of the sleeper with well compacted sandy gravel of Q3 type reinforced with two layers of geogrid. The ballast at both sides (and on top of the concrete slab) was replaced by a 35 cm thick layer of high quality ballast.

Apart from the fixed boundary conditions and the described technical structure, the maintenance activities (described by frequency and unit cost) have to be defined and established in the LCC analysis. This is a requirement if LCC for different systems or components are to be compared. As there was no detailed information for the reference system (especially costs for maintenance activities), the case without an optimised transition zone linked with speed limitation and huge costs (non-availability costs) has been taken as a reference system.

The costs for the optimised system consist in investment and maintenance. For the reference system, only the cost due to speed limitation has to be taken into ac-

count as a non-availability cost. However, the benefit of the optimised system is clear since the investment is not very large as compared to maintenance costs of the reference system distributed over the studied period.

With the optimal solution for the transition zone problem, the high maintenance costs due to the strong limitation of speed (reference system) could be removed and the economical benefit verified. The new method has been used to increase the stability of the subsoil before the track will be opened for a higher axle load. It has been successfully tested and can be applied with the benefit of achieving permanent subsoil improvement to mitigate the problems of stability, bearing capacity, settlement and track vibrations that can occur on existing railway lines.

#### LCC calculations for innovative slab track solutions

INNOTRACK has studied alternative support systems and proposes to evaluate and test innovative superstructure solutions as a new track system design. The aim is to develop an alternative solution to the ballasted track since increasing speeds and loads might bring the ballasted structure concept to its economical limits.

#### BB ERS – Embedded Rail System

An innovative solution exists in the form of the Embedded Rail System (BB ERS), where an existing concept and a modified design to deliver low manufacturing and low installation costs are analysed. The optimised components have been validated through comprehensive rail fastening tests.

The reference system is a standard ballasted track with a service life time of 40 years, rail type UIC 60 and a discrete support of the rail.

The optimised system is the BB ERS; an innovative slab track. Further details regarding this novel track system are given in section 4.3.2.

A 30% saving is potentially possible with this slab track system and the potential saving is indicated at certain tonnages for the embedded track. The graph in Figure 4.4-2 very clearly shows this. It also shows the influence of track loading on LCC. In this case identical LCC is reached at 38 MGT per year. For higher loading, the LCC of the BB ERS is lower than for ballasted track. The break-even point (return of investment) is between 10 and 20 years due to the needed reinvestment in rail renewal for the reference system. Compared to the total costs per track meter cumulated over 60 years (without the consideration of the discount rate) the cost of the ballasted track is higher than for BB ERS due to less maintenance and higher lifetime of track in the latter case. It should be noted that in the case of the BB ERS additional soil improvement was accounted for.

The LCC model includes all necessary track components and the LCC input data has been verified for ballasted and slab track. The costs of installing, maintaining and operating the systems have been modelled in the software D-LCC. The LCC input data has been independently verified. The model has been validated by DB using previously known costs and on the basis of the evaluated LCC benefit. A site to demonstrate the BB ERS has been identified at Waghäusel (Germany) and approval to move forward with this site has been at-

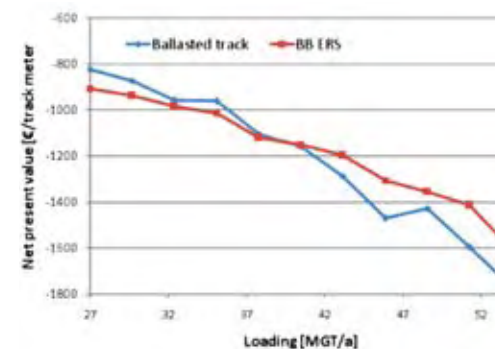

Figure 4.4-2: Net present value of ballasted track and BB ERS

tained. With the test site, the track quality retention and robustness should be confirmed and the LCC assumptions validated.

#### Two Layer Steel Track and ÖBB ladder track

Detailed analysis of the achievement of an LCC target has not been carried out for these two innovative systems, because of the difficulty of defining relevant reference cases and the fact that the systems are for application in very specific areas rather than for general application.

The Two Layer Steel Track system has an initial cost which is higher than ballasted track and was not intended to replace significant proportions of ballasted track. The cost of using the modified form of track for switches and crossings would result in an increase in materials costs of approximately 10k€ or 15% of the total cost, but train delay costs (in specific hot spots) may result in a reduction of total project costs by the same amount. LCC benefits become possible when train delay costs are taken into account and the benefits for consistent support in reducing s&c maintenance costs are realised, however these would merit further validation. Further work on the LCC analysis is recommended.

The ÖBB frame sleeper is designed for special boundary conditions (sharp curves with radius of  $R < 175$  meters). The solution has a high cost due to the additional installing of fastening assemblies, soft rail pads, premium rail (R350 HT), special tamping machinery so it is not suited for general use but to solve very specific problems.

#### Increased knowledge, implementable results and related cost reductions

The results are based on technical and economical verification of the solutions. The LCC input data has been independently verified. The LCC models have been validated using previously known costs and prognoses of increasing loads in the near future were taken into account as a



part of the decision making process. The targets of INNOTRACK are met with the BB ERS, which enables the operational cost to meet a potential LCC reduction of nearly 30%. The potential saving is indicated at a certain tonnage. The LCC analysis shows increased LCC savings for BB ERS as compared to ballasted track for higher loads.

For the cases of soil strengthening under existing railway embankment and for transition zone reinforcement, the cost drivers are identified as a starting point for technical innovation. The optimised technical solutions are evaluated and found to give significant cost savings. More results in terms of LCC benefits could not be evaluated due to lack of input data. In addition to the boundary conditions and the description of the technical structure of a system/product, the maintenance activities (described by frequency and unit cost) have to be defined and established in the LCC analysis. This is a requirement if LCC for different systems (reference and innovation system) or components are to be compared. This requirement could not be met in these two cases. Indeed, it appeared that subgrade characteristics are hard to be defined precisely in terms of boundary conditions for such a study.

#### Open questions

As stated above, subgrade boundary conditions for an LCC evaluation are difficult to define in a stringent manner in the establishment of an adequate reference system. The reason is that the evolution of all needed parameters and characteristics has normally not been monitored. In order to facilitate future LCC analysis it could be desirable to store these kinds of data. The work with measurements and database storage carried out in INNOTRACK could be a good starting point in such a quest.

#### References

1. INNOTRACK Deliverable D2.2.4, Description of measurement sites + LCC reference sites, 57 pp, 2009 [restricted to programme participants]
2. INNOTRACK Deliverable D2.2.5, Subgrade reinforcement with columns Part 1 Vertical columns, Part 2 Inclined columns, 122 pp (and 1 annex, 80 pp), 2009
3. INNOTRACK Deliverable D2.2.7, Substructure improvement of a transition zone on a conventional rail line, 68 pp (and 2 annexes, 8+15 pp), 2009 [restricted to programme participants]
4. INNOTRACK Deliverable D2.3.3, Design and manufacture of embedded rail slab track components, 32 pp, 2008
5. INNOTRACK Deliverable D2.3.4, Testing of the innovative BB ERS trackform, 40 pp (and 3 annexes, 22+15+1 pp), 2009
6. INNOTRACK Deliverable D2.3.5, A novel two-layer steel-concrete trackform for low maintenance S&C, 24 pp (and 1 annex, 13 pp), 2009
7. INNOTRACK Deliverable D2.3.6, Selection of a railway track system by best value analysis, 8 pp (and 2 annexes 3+6 pp), 2009
8. INNOTRACK Deliverable D5.3.1, First report on logistics & support, 13 pp, 2009
9. INNOTRACK Deliverable D5.3.2, Final report on logistics & support, 18 pp, 2009
10. INNOTRACK Deliverable D6.5.1, Modular LCC/RAMS models for SP2 to SP5, 30 pp (and 4 annexes, 4+25+8+3), 2009
11. INNOTRACK Deliverable D6.5.3, Comparable LCC analysis for SP2 to SP5, Comparable LCC analysis for SP2 to SP5, 35 pp (and 6 annexes 8+4+2+4+4+1 pp), 2009 [confidential]

# RAILS AND WELDING 5

# RAILS AND WELDINGS

---

In short, the aims of the studies on rails and weldings in INNOTRACK where:

- To study of degradation of rail steels and from this knowledge develop overview models that relate the degradation of different rail grades to operational conditions. This knowledge would then be used to improve current criteria for the selection of rail grades.
- To study rail degradation more in detail. The work aimed at establishing tolerances and limits of operational load conditions, and pertinent maintenance intervals and mitigating actions.
- Develop innovative laboratory tests of rail steel grades. Relate results from

the different tests to each other and to operational conditions through objective definitions of rail damage and through numerical simulations.

- To develop innovative inspection techniques and validate these through laboratory and field tests.
- To develop, formulate and validate new maintenance processes, in particular regarding grinding.
- To develop and validate innovative welding processes.

This chapter summarizes the results from this work.

## 5.1 Rail degradation and current minimum action rules

---

Any work aiming at improving the state-of-the-art in rail grade selection and maintenance needs a thorough understanding of rail deterioration under different operational conditions. To this end, INNOTRACK has brought together data and experience from a multitude of field tests carried out over a long time span by rail suppliers and infrastructure managers. From this

large compilation of operational data it was possible to draw conclusions and establish overview algorithms to predict rail degradation. The work also consisted in compiling and comparing current minimum action rules that govern the maintenance actions of different infrastructure managers.

## 5.1.1 Rail degradation

Rob Carroll, Corus

More information can be found in deliverable D4.1.4

### Background

The degradation of rail is a major cause of maintenance and renewal for all railways. To enable rail grade selection guidelines to be developed, a detailed understanding of the performance of the available rail steels under different loading conditions is required.

Over the last 30 years monitoring of small sections of track has been carried out throughout Europe by both Infrastructure Managers (IM's) and rail manufacturers. As part of INNOTRACK this data has been collated, analysed and used to derive rail degradation algorithms for wear and rolling contact fatigue (RCF) in the form of head checks. This understanding of rail degradation has been used to aid the development of rail grade selection guidelines to allow the use of premium grade rail steels in a cost effective manner.

### Degradation algorithms

Detailed site monitoring allows an understanding of the performance of current and new rail steels under operational conditions, but the variability in results mean that it is difficult to compare behaviour for different rail steels installed on different curves with different traffic patterns. An example of this is the results for  $45^\circ$  wear, Figure 5.1.1-1, where there is a general trend of increasing wear for tighter radius curve with premium grade rail steels exhibiting a greater resistance to wear. Reasons for the variability is the nature of the railway operations and the difficulty in measuring important factors such as the different types of vehicles, weather, maintenance regime etc.

To overcome this spread in results, averages have been taken for the different rail grades over specific radii ranges. From these averages, equations have been derived that describe the wear and RCF behaviour of rails as a function of their grade and the radius range in which they are installed. An example is given in Figure 5.1.1-2 for the growth of rolling contact fatigue cracks demonstrating that they predominate at radii between 700 and 3000 m. The results also demonstrate the greater resistance of premium grade steels to RCF.

### Application to track

Segmentation of a mixed traffic railway route has been carried out with the rail degradation algorithms applied to predict the degradation of each segment. This has been carried out in order to understand the relative importance of the different contributory factors and to demonstrate how the algorithms can be used to aid the development of rail grade selection criteria. This includes the effect on degradation of applying premium steels to all curves below a certain radii. An example of the effect on wear of the application of R370CrHT rail to curves of radii below 700m is given in Figure 5.1.1-3. The application of the derived rail degradation algorithms to rail grade selection is given in section 5.2.

### References

1. INNOTRACK Deliverable D4.1.4, Rail degradation algorithms, 41 pp, 2009

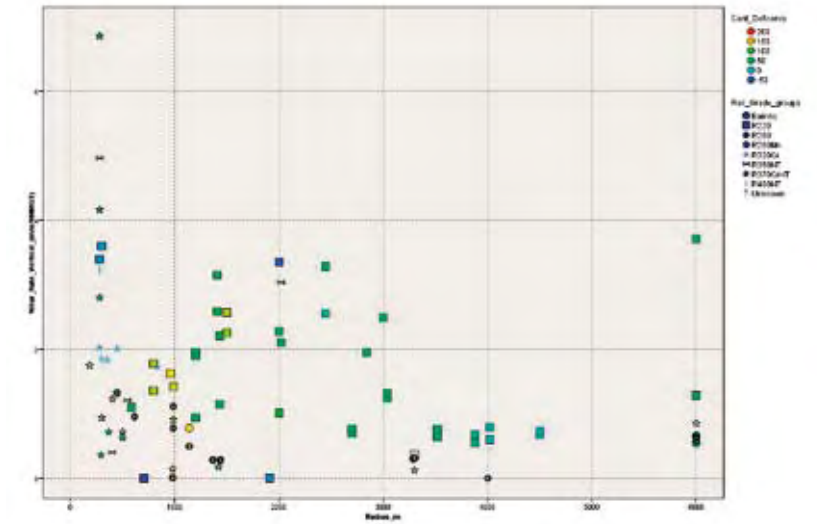

Figure 5.1.1-1:  $45^\circ$  Wear rate for different rail grades as a function of curve radius.

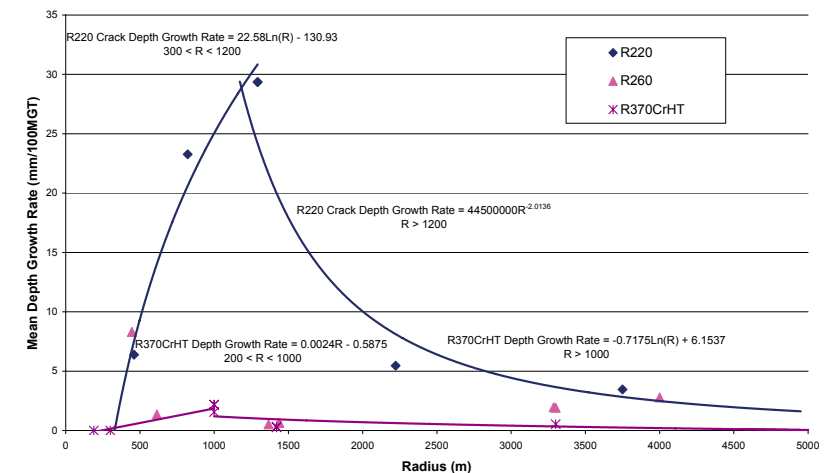

Figure 5.1.1-2: Crack depth growth rate algorithms for different rail grades

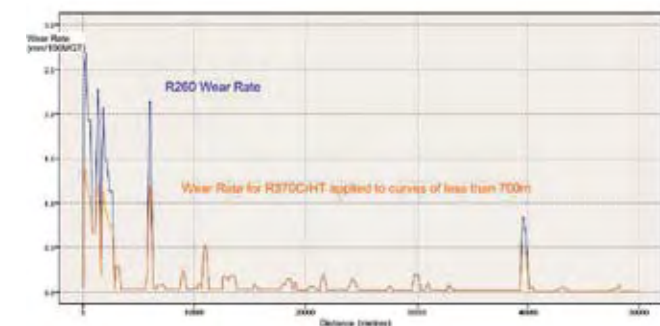

Figure 5.1.1-3: Predicted effect of premium grade rail steels on  $45^\circ$  wear for a 120 km route

## 5.1.2 “Minimum action” Rules

Rob Carroll, Corus

More information can be found in deliverable D4.2.6

### Background

A “minimum action” is the least that the responsible track engineer can do to ensure that the track remains safe on discovery of a broken or defective rail or weld.

All railway infrastructure managers (IM’s) undertake routine inspection, both visually and using non-destructive inspection techniques, such as ultrasonic or eddy current inspection. Once a defect has been found the question arises whether its severity is an immediate safety risk or a long-term risk. The minimum actions are guidelines that specify the actions to be taken to ensure the integrity of the railway.

Figure 5.1.2-1 demonstrates in a simplistic manner how these actions are implemented to ensure the safety of the railway from a crack in a rail. After initiation the cracks grow as time increases. Initially they are present but will not be discovered

by inspection. Only when they have grown to a certain extent will they be detected either visually or by non-destructive inspection. On detection, the track engineer has to decide whether it is a current risk that requires immediate removal or if it will become a risk in the future. The minimum action rules are used as a guide for decision making in this kind of situation. They specify a timescale in which the defect has to be removed. During this period, the crack will continue to grow until it is removed. The aim of the rules is to ensure a margin of safety remains even at the end of the action timescale.

The work carried out within INNOTRACK has been targeted at developing a scientific basis for minimum actions. To allow an understanding of the current situation across Europe a survey of the current minimum actions applied by the IM’s has been conducted.

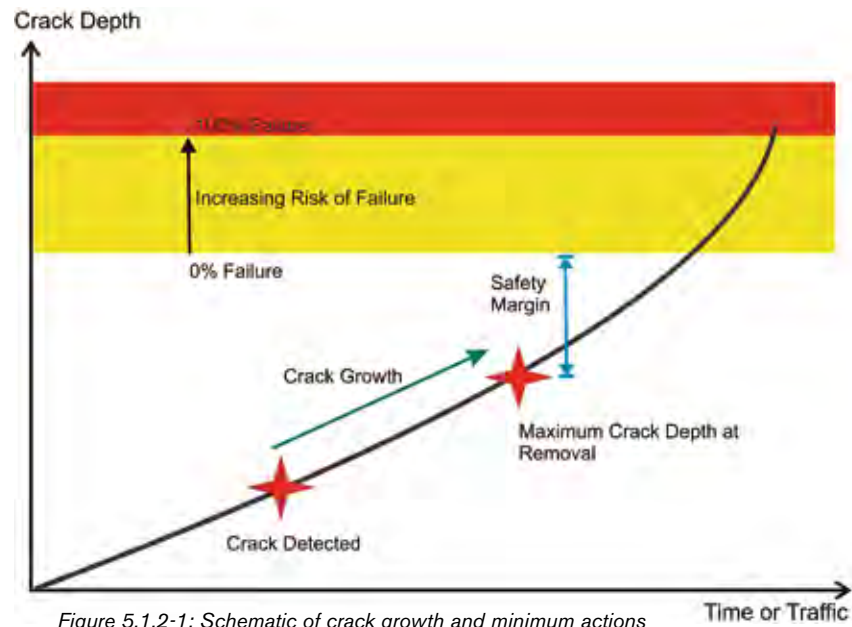

Figure 5.1.2-1: Schematic of crack growth and minimum actions

### Results

An overview of the current minimum actions used by different IM’s shows that there is a considerable difference in their approach to defects. For the same type of defect, such as a squat, there is a wide range of timescales and emergency actions required, Figure 5.1.2-2. Similar variations in required actions are seen for a number of different defect types. With a mixed traffic railway, such as operated by the IM’s within the INNOTRACK project, it would be expected that growth rates of defects will be similar, even when taking into account the different type of vehicles, track support stiffness, rail grades, profiles etc. The wide range of minimum actions encountered within Europe is thus likely to be, to a large extent, a result of historical experience with little scientific backing. There is therefore a requirement for a more solid scientific basis to be put in place behind the minimum actions to ensure that the railways remain safe especially under altered operational conditions. This would also allow a move towards preventive

rather than corrective maintenance. The scientific approach also allows an understanding of the integrity of the railway resulting from a step change, such as a change in the inspection regime or the introduction of a slab track system.

The work in INNOTRACK on minimum actions uses two different approaches. The first involves detailed modelling to understand how different types of defects initiate and grow under a range of loading conditions, see sections 5.3.1 – 5.3.5. The second develops prediction rules, to be able to tell when a crack reaches a critical size that may result in rail failure under real world conditions, see sections 5.3.6 and 5.3.7. It is through the combination of these approaches that new minimum actions can be proposed.

### References

1. INNOTRACK Deliverable D4.2.6, Recommendation of, and scientific basis for minimum action rules and maintenance limits, 126 pp (and 6 annexes, 9+8+10+9+10+33 pp), 2009

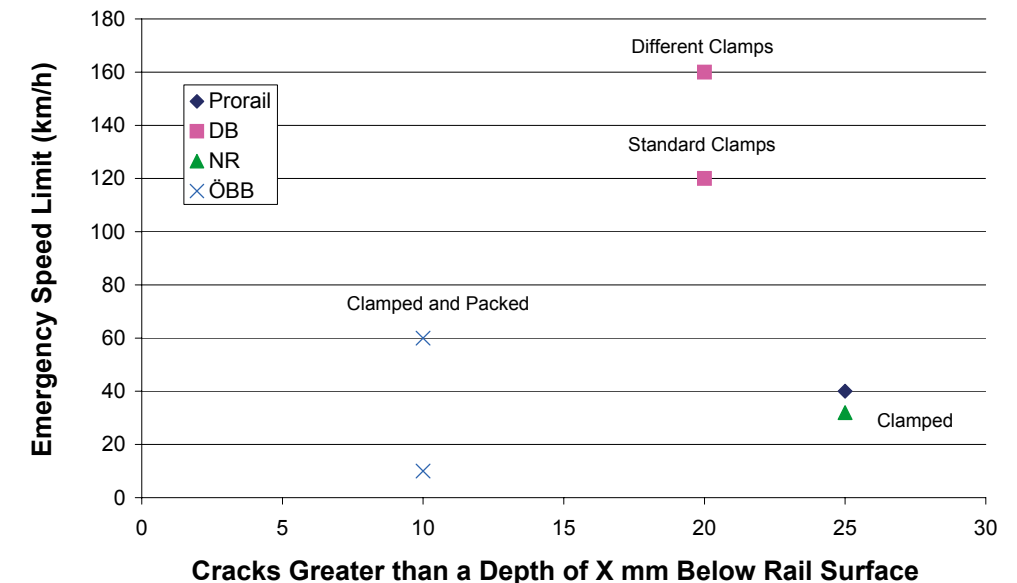

Figure 5.1.2-2: Comparison of emergency speed limits for clamped single squats

## 5.2 Rail grade selection

Peter Pointner and Albert Jörg, voestalpine, Jay Jaiswal, Corus

More information can be found in deliverable D4.1.5

The formulation of the rail grade selection recommendation [D.4.1.5] represents a very special part of the entire INNOTRACK project. In contrast to other work packages of the project, the tasks in this work packages on rail were not focussed on the development of a new rail grade. Instead, the objective was to define the optimum areas of application of the already available rail grades including the heat treated grades cited in the Euronorm (prEN 13674:2009). The outstanding properties of heat treated rail grades are well reflected in their resistance to the dominant degradation mechanisms of wear and rolling contact fatigue and hence their use becomes even a stronger necessity to counter the acknowledged future demands at the wheel-rail interface from increased axle loads, traffic density, and reduced maintenance windows.

Two different rail grade selection recommendations have been proposed:

1. A “traditional” radii based approach modified to reflect the improved knowledge from the developed rail degradation algorithms.
2. A “innovative” deterioration based approach that recognises that variation in traffic characteristics can alter rail degradation behaviour.

Both approaches consider the rail steels covered by the prEN1367-1:2009 [2] and are substantially based on operational experience and scientific work.

The operational experience is provided by detailed analyses of a large number of different track tests performed by voestalpine and Corus in cooperation with different railway administrations. The experience can be summarized as follows:

- Tight curves show high wear-rates, which decrease significantly with increasing radii.
- Especially wide curves with radii above approximately 500 m are affected by rolling contact fatigue (RCF).
- Compared to standard rail grades, heat-treated rails show superior resistance to both wear and RCF.

This conclusion is also strongly supported by scientific publications and the results of several (full scale and small scale) laboratory tests, also performed within the INNOTRACK project.

The study concludes that wear is the predominant degradation mechanism in tight curves and rolling contact fatigue (RCF) in wide curves (up to 5 000 m), as indicated in Figure 5.2-1. Consequently, this range of radii must be covered by a

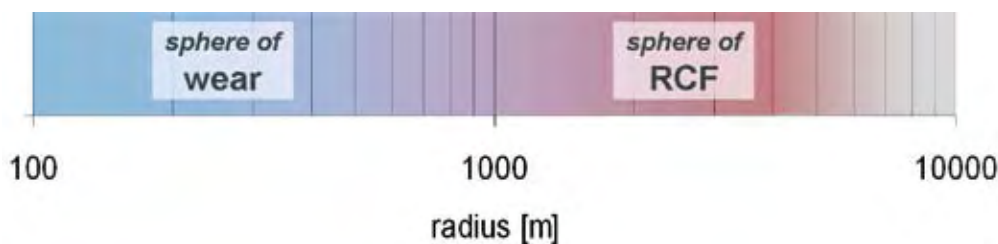

Figure 5.2-1: Predominant degradation mechanisms for different rail radii

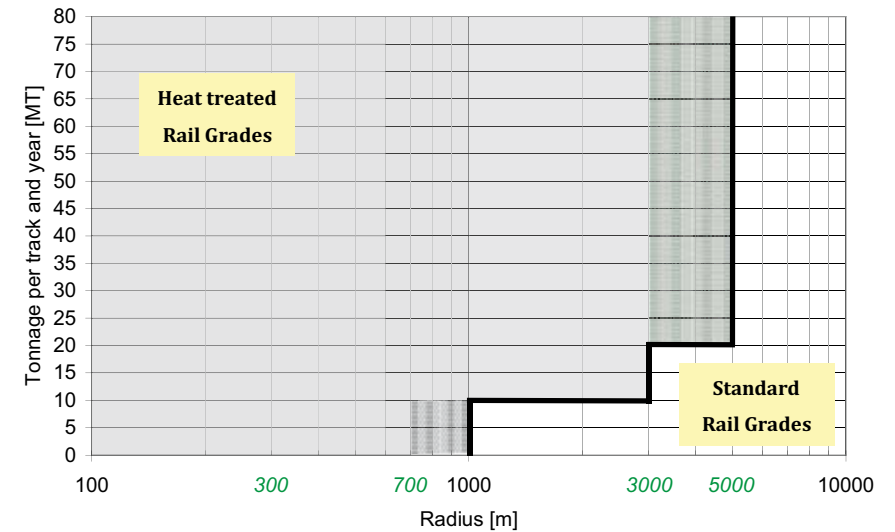

Figure 5.2-2: Revised rail grade selection recommendation based on rail radii and operational volume

recommendation for rail grade selection. A radii based rail grade selection recommendation, which has been developed within the INNOTRACK project is presented below. Depending on the curvature and the annual accumulated traffic (expressed in total gross tons) the appropriate rail steel grade is given by Figure 5.2-2. It is apparent that the recommendation of the use of heat treated rail grades covers several grades available within prEN13674-1:2009 and hence suggests overlaps between different rail grades; there is a choice of several steel grades for a certain radius. This allows infrastructure managers to reflect their experience into the choice of a rail grade. Furthermore, the overlap provides cover for the observed scatter in degradation rates and mechanisms caused by variations in track characteristics and operational conditions. The proposed recommendation can be seen as a suggested revision of the UIC leaflet 721.

In summary, for heavily and moderately loaded tracks the suggested steel grades are:

- For tight curves (rail radius  $R < 300\text{m}$ ), (R370CRHT) grade is recommended.

- For medium curves ( $300\text{m} < R < 700\text{m}$ ), R370CRHT (also R400HT for heavily loaded tracks) grade is recommended followed by R350HT steel grade at the higher end of the above radii range.
- In case of heavily loaded tracks, R350HT steel grade is also recommended for wider curves with radii between 3 000m and 5 000m. (R260 rail grades may be an appropriate solution if RCF is negligible.)

For lightly loaded tracks the recommendation is:

- Use of the R350HT steel grade in curves with radii up to 700m to 1 000m depending on the local boundary conditions.

The second approach to defining a rail grade selection criteria is based on the knowledge of the dominant degradation mechanism (key cause of rail replacement) under the operational boundary conditions of the specific site.

In this novel deterioration based rail grade selection criteria, the starting point is the rail degradation behaviour of the currently installed steel grade. Depending on the severity of wear and/or RCF, a rail grade selection recommendation is given.

actual installed rail steel		DETERIORATION BASED RAIL GRADE SELECTION			
R260					
WEAR 45° wear rates on high rail - calculated out of the absolute wear measured in track	SEVERE >15 mm / 100MT	R400HT	R400HT	R400HT	R400HT
	HEAVY ≤15 mm / 100MT	R370CrHT	R370CrHT	R400HT	R400HT
	MODERATE ≤5.0 mm / 100MT	R350HT	R350HT	R370CrHT	R400HT
	LIGHT ≤2.0 mm / 100MT	R260	R350HT	R370CrHT	R370CrHT
The rail deterioration behavior of the actual installed rail steel defines the appropriate choice of a rail grade to be inserted within the next track relaying action in order to achieve an optimum rail degradation behavior. In case of dominating wear (curves) the use of the recommended rail grade is suggested for both high rail and low rail (plastic deformation).		LIGHT ≤0.5 mm / 100MT	MODERATE ≤1.0 mm / 100MT	HEAVY ≤3.0 mm / 100MT	SEVERE >3.0 mm / 100MT
Head Check crack depth rate - calculated out of measured crack depths detected in track					
ROLLING CONTACT FATIGUE					

Figure 5.2-3: New deterioration based rail grade selection recommendation

RCF crack depth rate	WEAR 45° wear-rates	RAIL GRADE SELECTION			
		R260	R350HT	R370CrHT	R400HT
light ≤0.5 mm/100MT	light ≤2 mm/100MT	⊗	→	→	→
moderate ≤1.0 mm/100MT	moderate ≤5 mm/100MT	→	→	→	→
heavy ≤3.0 mm/100MT	heavy ≤15 mm/100MT	→	→	→	→
severe >3.0 mm/100MT	severe >15 mm/100MT	→	→	→	⊗

Figure 5.2-4: Rail degradation behaviour of different rail grades

The recommendation will then correspond to the steel grade suitable to counteract the dominating rail degradation mechanism. It should be noted that the deterioration based rail grade selection criteria removes the emphasis on curve radius or the magnitude of traffic carried. Instead it is based on the actual rail degradation behaviour of the installed rail under the boundary conditions prevalent at that site.

As the deterioration behaviour of the actual installed rail grade provides the basis for the recommendation, a distinct recommendation chart was elaborated for every possible installed rail grade. Figure 5.2-3 shows the deterioration based rail grade selection recommendation for the case of an installed R260 grade.

To determine the appropriate steel grade for a certain section, a three-step procedure is proposed. Step one is the choice of the appropriate recommendation chart. Step two is the classification of the measured wear-rate and measured crack growth rate of the studied section. The third step is the determination of the appropriate steel grade for the section.

By choosing rail steel with an improved hardness, the rate of damage can be significantly reduced. Thus the replacement of a R260 grade rail steel with a R350HT grade can reduce wear by a factor of between 3 and 5, while the RCF resistance is increased by a factor of between 2 and 5. These relationships are also indicated in Figure 5.2-4. Thus for a site with R260 grade rail that is exhibiting “Moderate” wear, replacement with R350HT grade rail would result in the rate of wear being reduced to “Light” over the same time span.

The improved rail durability arising from a shift towards premium grade steels, will lead to a significantly reduced life-cycle cost. LCC calculations within INNOTRACK have clearly demonstrated the high influence of using an appropriate steel grade on the total LCC cost of an entire track. In particular replacing standard grade rails

(R260) with heat treated rail grades can give huge LCC savings due to the increased durability of the rails and the related extension of grinding intervals, see chapter 9. In addition to demonstrating the high economic benefit of heat-treated rail grades, the performed LCC calculations also show that the amortization of the slightly higher investment of heat-treated rails takes place in a very short period after installation (down to 2 years).

#### References

1. INNOTRACK Deliverable D4.1.5, Definitive guidelines on the use of different rail grades, 45 pp, 2009
2. prEN13674-1:2009, Railway applications - Track - Rail - Part 1: Vignole railway rails 46 kg/m and above, CEN: European Committee For Standardization, Brussels, 2009
3. UIC leaflet 721, Recommendations for the use of rail steel grades, 15 pp, 2005

## 5.3 Deterioration of rails and joints

To establish a scientific foundation for improved minimum action rules, INNOTRACK has carried out in-depth investigations of selected modes of deterioration. These include squats, corrugation, wear, insulated joints, rail crack growth and fracture. The studies include numerical simulations verified towards laboratory or field tests. The results are summarized in recommendations as to how minimum action regu-

lations should be formulated and which the important factors are. The results are summarized in the following sections and also presented in detail in a guideline: INNOTRACK Deliverable 4.2.6, “Recommendation of, and scientific basis for minimum action rules and maintenance limits”.

### 5.3.1 Squats

Zili Li, TU Delft

More information is available in Deliverables D4.2.4 and D4.2.6.

#### Background

In the case of squats, the main purpose of the work carried out in INNOTRACK was to clarify initiation sources, how such initiated defects grow into typical squats, and the effect of loading conditions. The focus was on the early and intermediate stages of squat development in an effort to identify squats and the related causes as early as possible so that low life cycle costs can be achieved by timely maintenance.

Considering the development process/life cycle of squats, the definition of squats has been extended based on the definition of UIC712R (defect 227). With reference to the new definition, squats include not only the matured ones that have the typical characteristics described in UIC712R, but also the small rail top geometrical defects that will later grow into fully developed squats. The later is referred to as light squats, though they do not yet bear the characteristics of conventionally accepted matured squats.

The information employed in INNOTRACK has mainly been from the Dutch railway, with some supplementary data from Network Rail, DB, Banverket and InfraBel.

#### Increased knowledge, implementable results and related cost reductions

Based on correlation analyses of track measurement data and observations, it was found that squats should be a result of high frequency interaction between wheel and rail, with influence from the local wheel-track system. Consequently a finite element (FE) model was developed which treats the frictional dynamic rolling contact at geometry irregularities in three dimensions. As an important step forward in frictional rolling contact and in vehicle-track interaction the solution of the contact is integrated in the

local vehicle-track system, such that the interplay between the rolling/impact contact and the local system is taken into account.

In general, light squats can be any small rail top geometrical defects, which can cause sufficiently large high frequency wheel-rail interaction (impact). In light of this definition, the defects can be indentations, short pitch corrugation, small wheel burns, cracks, etc. The dynamic contact force at the defect causes accumulation of plastic deformation, so that the defects grow due to ratcheting into typical matured squats. The process imposes a positive feedback: the dynamic force causes growth of the defect and vice versa. The employed criterion for plastic deformation at the rail surface is that the von Mises stress exceeds the yield strength of the material. The yield strength increases with hardening, until the tensile strength is reached. The defects do not necessarily need to have cracks in the beginning. Therefore cracks are not considered in this work.

The work in INNOTRACK has led to the following findings and conclusions:

- Squats initiate and grow from small rail top geometrical defects that are larger than a critical size.
- The critical size has been determined for typical ProRail loading conditions: When the length and width of a defect in the running band is larger than 8mm, the chance for it to grow into a squat is very large. When the length and width is less than 6mm, the chance to grow into a squat is very small. Figure 5.3.1-1 shows an example of the calculated von Mises stress for the determination of a critical size. Field monitoring has validated the determined critical size. Similar critical sizes can be determined for other opera-

tional conditions of other railways with the procedure developed in INNTRACK. The critical size may be applied directly to visual inspection and classification of squats so that trivial defects can be distinguished from light squats and false reporting of squats can be avoided. The critical size can be applied as a minimum action rule for preventive or early corrective maintenance actions, such as rail grinding. The numerical model may also have the capability to relate the size of squats quantitatively to some measurement of the dynamic wheel-rail interaction so that automatic detection of the defects at an early stage is possible.

- The process of a light squat growing into a matured squat has been investigated, see Figure 5.3.1-2. A light squat, the A1 part of squat A, will excite at its trailing edge a dynamic contact force variation corresponding to a certain wavelength, which results in a series of subsequent contact force peaks. This load pattern is repeated at every wheel passage at the same location, causing spot-wise localized ratcheting. The plastic deformation caused by the first two force peaks, F1 and F2, will eventually cause the light squat A1 and the subsequent indentation B1 corresponding to the following impact position to form the two lung-like parts A2 and B2 of squat B. Squat B will further grow and may cause a rail break if no remedial action is taken.

- About 33% of squats in the Netherlands are caused by short pitch corrugation.
- About 41% of squats in the Netherlands have corrugation-like wave pattern that follows them. The wavelength of the wave pattern is usually between 20 – 40 mm, as a result of the dynamic contact force.
- The wave pattern of squats bears similarity with short pitch corrugation. The growth of squats and corrugation should be closely related to the eigen characteristics of the local vehicle-track system. Research on squats and corrugation should, to certain extent, join hands.

- The impact between wheel and rail at a squat will excite dynamic response of the wheels, with certain characteristic frequency components corresponding to the wavelength of the dynamic force. Such dynamic response may be measured for automatic detection of squats, especially early squats.
- Initiation and growth of squats are strongly promoted by a tangential contact force.
- There are evidences that improper traction control of the rolling stock is related to squat occurrences.
- Differential wear and differential plastic deformation can cause rail top geometrical deviation. They can therefore cause squats.
- Sudden stiffness change in the track structure, accompanied by other defects in the track, may cause singular differential wear and differential plastic deformation, leading to squats. This typically occurs in switches and crossings in the Netherlands, and sometimes also at the ends of fishplates.
- In the process of a light squat growing into moderate squats, cracks do not necessarily play a role.

#### Open questions

There are still many open questions. Some of them are:

- How do cracks initiate and grow in the vicinity of squats?
- What is the influence of the grade, metallurgy and microstructure of the rail material on squat initiation and growth?
- Does the white etching layer sometimes found on the rail top play any role in the initiation and growth of squats?
- What is the relation between the wave pattern caused by squats and the short pitch corrugation?
- How to detect squats, especially at their early stage, by measurement of dynamic response at the squats?

#### References

1. INNTRACK Deliverable D4.2.4, Improved model for loading and subsequent deterioration due to squats and corrugation, 37 pp (and 7 annexes, 7+10+9+10+8+8+26 pp), 2009
1. INNTRACK Deliverable D4.2.6, Recommendation of, and scientific basis for minimum action rules and maintenance limits, 126 pp (and 6 annexes, 9+8+10+9+10+33 pp), 2009
3. UIC Code 712CR, Rail defects, 4th edition, January 2002.

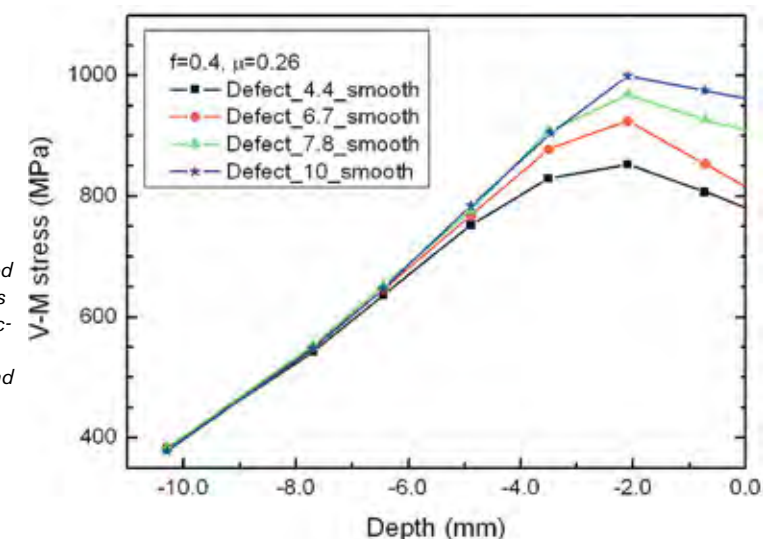

Figure 5.3.1-1: Calculated maximal von Mises stress at small defects as a function of depth in the rail, traction coefficient ( $\mu$ ) and friction coefficient ( $f$ ) for the purpose of determining a critical size.

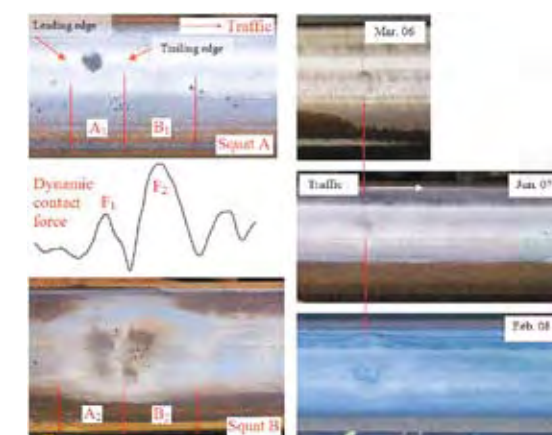

Figure 5.3.1-2: Numerical postulation of squat growth process (left) and corresponding growth pattern in field (right).



## 5.3.2 Corrugation

Jens Nielsen, Anders Ekberg and Elena Kabo, Chalmers

More information is available in Deliverables D4.2.1, D4.2.4 and D4.2.6.

### Background

The corrugation studied in INNOTRACK consists of small amplitude undulations with wavelengths of the order of 1–10 cm on the running surfaces of wheels and rails. These can induce vibrations that cause rolling noise and high-frequency vertical wheel–rail contact forces that in turn may cause subsurface initiated rolling contact fatigue (RCF) in wheels and rail.

Current regulations on the allowed limit for corrugation vary throughout Europe and mainly consider the influence on noise generation. In the UIC series of technical and research reports, rail corrugation is included under topic D 185. The European norm EN 15610:2009 regulates measurements of corrugation.

This study concerns tangent track operations on modern tracks and speeds in the order of 200 km/h for passenger wagons and 100 km/h for freight wagons.

The aim of the study was to investigate the character of corrugation and to derive a scientifically based acceptance criterion that accounts both for noise pollution and magnitudes of induced vertical forces.

### Increased knowledge, implementable results and related cost reductions

The study has shown that an increase in corrugation can be expressed by the scaling of a corrugation spectrum, see Figure 5.3.2-1. Using scaled corrugation spectra, parametric studies were carried out. The simulations featured validated numerical models that can account for the high frequency contributions. The main conclusions were:

- For the cases studied it is found that a major contribution to the vertical wheel–rail contact force lies in the frequency domain 200–1500 Hz.

- A given speed increase will increase the maximum RCF loading and the noise emission (dB(A)). This increase has been quantified in the study.
- An increased axle load will increase the mean value of the RCF loading, but the load scatter due to the corrugation will decrease. Normally the result will be a net increase in maximum RCF loading. There is basically no influence of the unsprung mass.
- Limiting noise emissions requires stricter limits on the rail roughness for freight operations as compared to passenger traffic. The reason is the rougher wheel tread surfaces of freight wheels.

Acceptance criteria for rail corrugation have been developed in the following manner: Given the operational conditions sound pressure levels are evaluated for varying magnitudes of corrugation. The risk of RCF is assessed. Allowed rail corrugation magnitude is then defined as the highest magnitude for which noise emissions and RCF loadings are acceptable.

The procedure can be summarized in design charts, see Figure 5.3.2-2. For other operational conditions and/or refined studies, numerical tools to predict wheel–rail interaction and resulting RCF loading and noise emissions exist (DIFF, TWINS, FIERCE) and have been validated against field measurements.

The major potential cost reductions for the work in INNOTRACK comes from a much more precise definition of the allowed corrugation magnitude and which influence a change of these will have.

The results from INNOTRACK are directly implementable in codes and regulations.

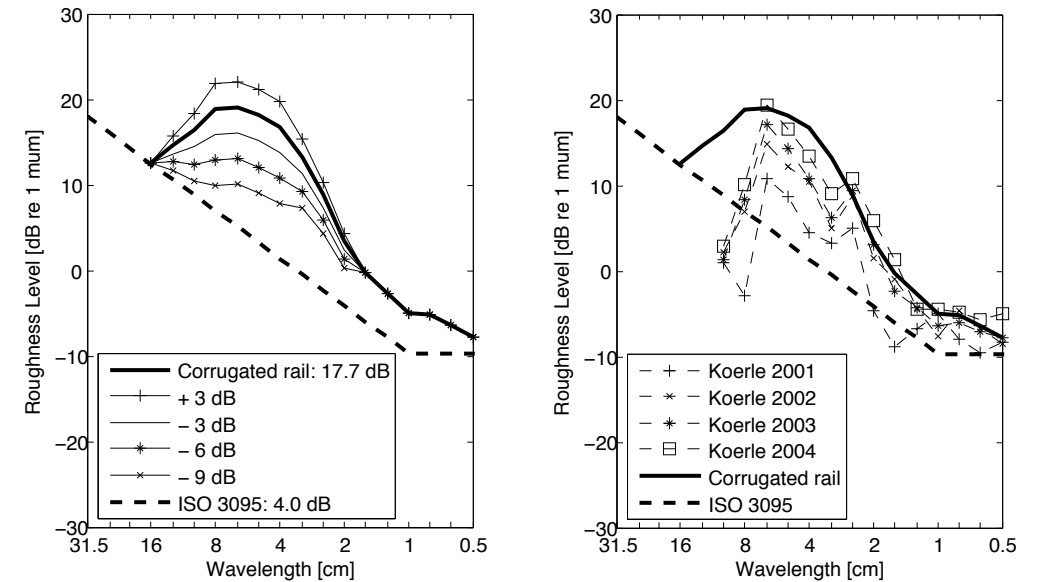

Figure 5.3.2-1: Rail roughness level spectra used in the parametric studies (left) and comparison to corrugation spectrum in Koerle (right). From [4].

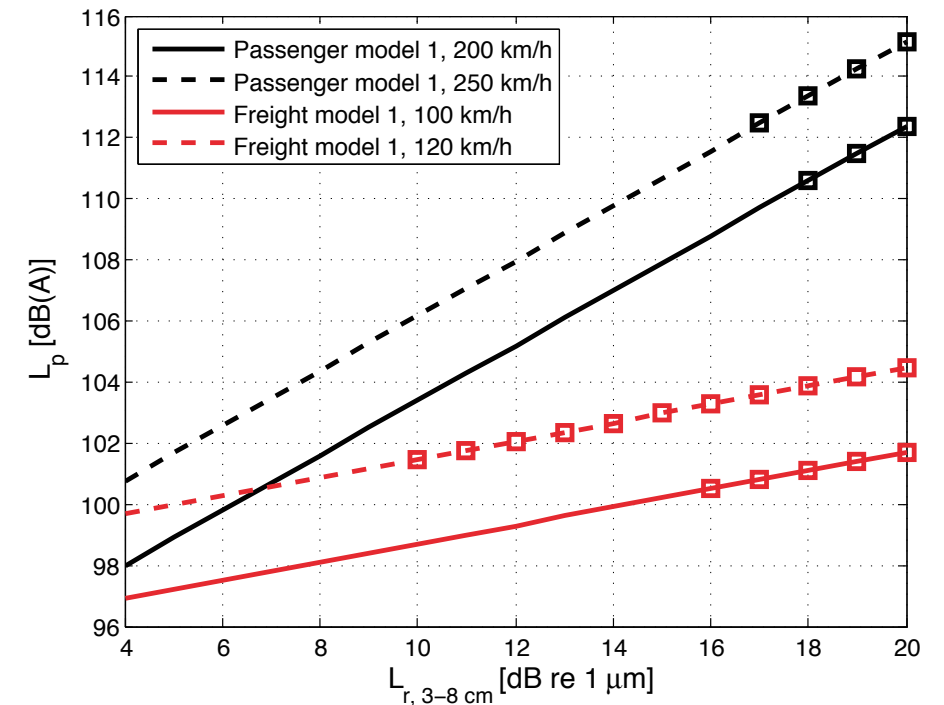

Figure 5.3.2-2: Demonstration example of the establishment of operational acceptance limits: influence of mean rail roughness level on SPL at 7.5 from track centre. Operational cases that pose a risk for subsurface initiated RCF are marked with squares. From [5].

## Open questions

The question of corrugation growth has not been investigated in INNOTRACK (though studies exist in the literature). Furthermore, the influence of corrugation on surface initiated RCF has not been addressed. Finally, the analysis should be extended to a much wider range of operational conditions than the limited study in INNOTRACK allowed. Setting out from the work in INNOTRACK this is rather straightforward.

## References

1. INNOTRACK Deliverable D4.2.1, The impact of vertical train-track interaction on rail and joint degradation, 22 pp (and 10 annexes, 27+25+10+12+6+8+7+7+25+4 pp), 2007
2. INNOTRACK Deliverable D4.2.4, Improved model for loading and subsequent deterioration due to squats and corrugation, 37 pp (and 7 annexes, 7+10+9+10+8+8+26 pp), 2009
3. INNOTRACK Deliverable D4.2.6, Recommendation of, and scientific basis for minimum action rules and maintenance limits, 126 pp (and 6 annexes, 9+8+10+9+10+33 pp), 2009
4. Jens C O Nielsen & Anders Ekberg, Subsurface initiated rolling contact fatigue and rolling noise – influence of train speed and rail roughness, Research report 2009:04, Department of Applied Mechanics, Chalmers University of Technology, Gothenburg, Sweden, 26 pp, 2009
5. Jens C O Nielsen & Anders Ekberg, Acceptance criterion for rail roughness level spectrum based on assessment of rolling contact fatigue and rolling noise, Proceedings of the 8th International Conference on Contact Mechanics and Wear of Rail/Wheel Systems, Florence, Italy, September 15-18, pp 409-418, 2009

## 5.3.3 Wear

Francis J. Franklin, Gordana Vasic, Newcastle University; David I. Fletcher, Sheffield University  
More information is available in Deliverables D4.2.5, D4.2.6 and D4.3.7.

### Background

Wear is the material removal from rail/wheel surface due to their interaction. Wear can be quantified by measuring the amount of metal loss (typically through railhead profile measurement or mass measurement of test specimens).

Rail wear influences both vehicle performance and rail life. Loss of material from the railhead (and also displacement through plastic deformation) has the effect of changing the rail profile. This will affect vehicle dynamics and consequently the position of wheel/rail contact, and may lead to increased stresses in the material. This leads to reduced ride quality, higher risk of formation of cracks, and a reduction in overall safety. Periodic grinding is carried out to maintain the rail, usually to correct the profile but grinding also removes small cracks. Grinding is a costly, but necessary, process and it shortens the rail life more than natural wear, so rails need replacing more frequently as a result.

Wear related work in INNOTRACK focuses on: wear-hardness correlation; wear model development, calibration and validation; rail wear predictions; and the influence of out-of-round wheel pressure variations on rail wear. A series of SUROS twin-disc tests and further metallurgical analysis have been performed to support the research.

### Increased knowledge, implementable results and related cost reductions

The research in INNOTRACK consisted of both experimental and modelling work and has produced a novel computer model for wear prediction. SUROS twin-disc testing proved to be a reliable method of testing new premium grade steels.

Five pearlitic rail steels (CORUS 260, CORUS 350, CORUS 400, VA 350 and VA 400) were tested against R7 wheel steel (with one additional test for each against R8T wheel steel). Three twin-disc tests were performed for each rail steel: 5000 cycles dry; 5000 cycles dry followed by 5000 cycles wet (i.e., water-lubricated); and 15000 cycles dry. Following testing, the discs were sectioned and a series of microhardness measurements made from the surface to a depth of 10mm. Plastic shear strain was estimated from optical micrographs of the etched microstructure, and combined with the micro-hardness data to create material models for wear prediction. Measured wear rates were used to calibrate the wear model and to study the effect of rail disc hardness on wheel disc wear rate.

In general, the harder the rail disc material becomes at the surface, the harder the wheel disc material becomes at its surface. Rail disc wear decreases when rail steel hardness increases. In wet tests, wheel disc wear rate drops as rail disc hardness increases. In the system as a whole (i.e., considering both wheel and rail discs), using harder CORUS 400 and VA 400 rail steels lowers the total wear rate.

From a review of the academic literature, there is no conclusive finding that harder rails wear wheels more, or vice versa. In general, harder materials wear less, but material hardness is not the only determining factor of wear performance; microstructure and strain-hardening behaviour are additional critical factors. Further, rolling contact fatigue performance is equally important. However, as a fairly general rule:

- To reduce system wear, harder steel grades should be used for both wheel and rail.

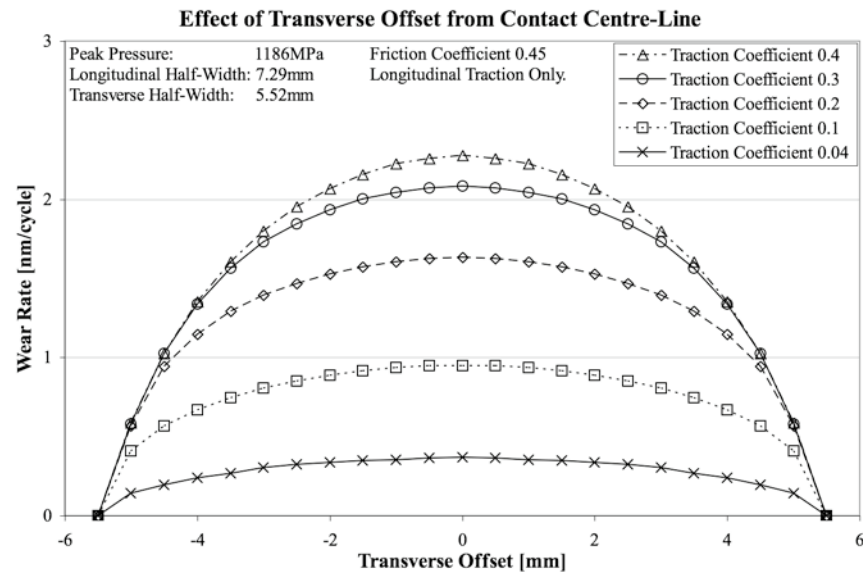

Figure 5.3.3-1: Predicted wear rates, averaged over 100000 cycles, for a range of longitudinal traction coefficients (with coefficient of maximum friction 0.45) and normal load 100kN. The transverse half-width is 5.52mm, and wear rates are evaluated in 0.5mm intervals from the centreline to the edge of the contact.

The wear model, calibrated for CORUS 260 and dry contact, was used to study the effect on rail wear of vehicle characteristics through their effect on the wheel-rail contact. The wear rate is maximum under the centreline of the wheel-rail contact and drops to zero near the edges of the contact; Figure 5.3.3-1 shows this effect for a selection of traction coefficients – clearly wear rate increases as the traction coefficient increases.

Wear rate increases also as the normal load, and thus peak pressure, increases. Figure 5.3.3-2 shows predicted wear rates for a range of normal loads – the wear rate increases linearly with peak pressure. Wear rate also increases with time, starting low when the rail is relatively undamaged, and increasing asymptotically to a ‘steady state’ wear rate.

The three curves in Figure 5.3.3-2 shows evaluated wear rates averaged over (from bottom to top) the first 10 000 wheel passes, all 100 000 wheel passes of the simulation, and the final 10 000 wheel passes (used to determine the asymptotic

behaviour). These results have been used to construct the following simple wear equations. The average wear rate over the first 100 000 wheel passes is given by:

$$\bar{w} = 0.2 \frac{t_c}{\mu} \left( 3 - \frac{t_c}{\mu} \right)^2 (2.3226p - 0.6761)$$

Here  $p$  is peak pressure [in GPa],  $t_c$  is the traction coefficient, and  $\bar{w}$  is the average wear rate [in nm/cycle]; friction coefficient is fixed as  $\mu=0.45$ , suitable for dry conditions. The asymptotic wear rate (i.e., the ‘steady state’ wear rate, usually achieved by 100 000 cycles) is given by:

$$w = 0.2 \frac{t_c}{\mu} \left( 3 - \frac{t_c}{\mu} \right)^2 (2.5513p - 0.5579)$$

Both wear rate equations are linear functions of pressure (which for Hertzian contact conditions is proportional to the cube root of the normal force), for a fixed traction coefficient, so the final wear pattern will be a linear function of pressure.

To calculate profile area loss, the wear rate should be multiplied by the width of the contact. Contour plots of profile area loss against traction coefficient and normal load are presented in Figure 5.3.3-3.

The equations are based on dry contact and CORUS 260 rail steel. The results are applicable to contact at the head of the rail with only longitudinal friction forces, either from traction of locomotives and multiple units or from braking.

The effect of pressure variation (with wavelengths above about 20 mm) on the rail wear rate was studied by considering each wheel pass as an independent event. Wear simulations were thus performed by varying the normal load with each passing wheel, and the predictions compared with the constant average-load case. No significant difference was observed. The conclusion is that out-of-round pressure variations do not affect rail wear significantly.

The results obtained from INNTRACK can be implemented as a methodology when choosing the right rail steel for replacing track and for improved planning of rail maintenance. At first, new proposed rail steel grades should be tested in the laboratory to calibrate models of wear and RCF. Then rail material degradation will be simulated in conjunction with type of traffic, loads and wheel steels. As a further recommendation for routes where harder wheel steels are used, rail profiles should be selected carefully to match the wheel profile – especially where harder rail steels are also used – to ensure optimum system wear performance and reduce the potential for RCF. For predominantly dry environments, premium grade wear-resistant steels should provide a cost-effective solution for maximizing rail life. Locations where a long wet spell follows a long dry spell should be inspected more frequently.

Cost savings will be obtained by using this methodology to decide the best steel for route. Improved maintenance reasoning will facilitate better planning and optimised inspection intervals and actions.

#### Open questions

The test work, metallurgical analysis and wear model development carried out within INNTRACK provides the basis for

further development of a more general wear prediction models that will be valid for premium grade rail steels and have a possibility to incorporate a range of coefficients of friction and a range of contact locations across the railhead. To provide a predictive tool of use to infrastructure managers, the wear equations can be incorporated into train-track interaction simulations (e.g., VAMPIRE) to study rail profile evolution, roughness growth and fatigue life.

#### References

1. INNTRACK Deliverable D4.2.5, Improved model for the influence of vehicle conditions (wheel flats, speed, axle load) on the loading and subsequent deterioration of rails, 47 pp (and 6 annexes, 48+14+9+22+35+51 pp), 2009
2. INNTRACK Deliverable D4.2.6, Recommendation of, and scientific basis for minimum action rules and maintenance limits, 126 pp (and 6 annexes, 9+8+10+9+10+33 pp), 2009
3. INNTRACK Deliverable D4.3.7, Innovative laboratory tests for rail steels – Final report, 26 pp (and 1 annex, 5 pp), 2009

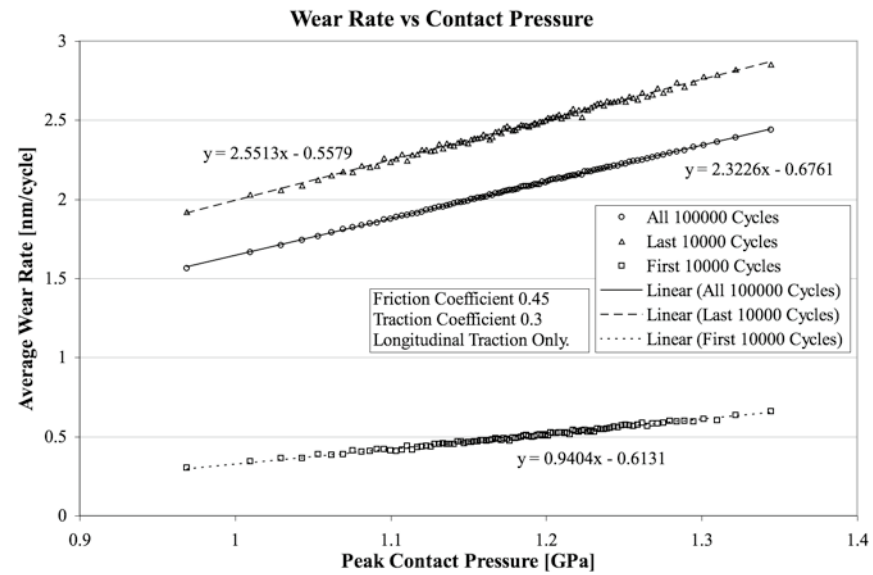

Figure 5.3.3-2: Wear rates from simulations over 100000 cycles showing the effect of pressure.

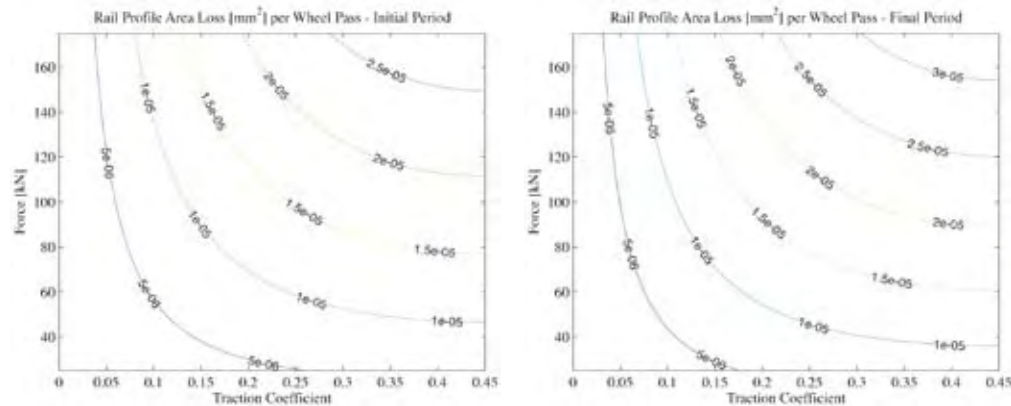

Figure 5.3.3-3: Contours of wear rate (profile area loss per wheel pass, in  $\text{mm}^2$ ) against traction coefficient (for friction coefficient  $\mu=0.45$ ) and normal load. Left: Averaged over initial 100 000 cycles. Right: Averaged over final 10 000 cycles of simulations over 100 000 cycles.

### 5.3.4 Insulated joints

Johan Sandström, Jóhannes Gunnarsson, Elena Kabo and Anders Ekberg, Chalmers  
Francis Franklin and Gordana Vasic, Newcastle University  
More information is available in Deliverables D4.2.1, D4.2.3 and D4.2.6.

#### Background

Insulated joints are used to electrically insulate two sections of a track from each other. The sectioning is utilized for signalling purposes. When a train enters a track section, its wheelset short circuit the rails and hence the section with a short circuit identifies the location of the train. By identifying which track section is short-circuited the position of the train is known.

The joint imposes a variation in track stiffness, which together with local rail surface irregularities caused by misalignment and plastic deformations of the rail ends causes high impact loads. In addition, the insulating material is very flexible in comparison to the rail, which causes severe stress concentrations that promote plastic deformation and subsequent cracking and/or short-circuiting of the joint. This leads to operational disturbances and the need for unplanned maintenance.

The work in INNOTRACK focuses on determining wheel-rail contact loads at joints and the related material deterioration of the joint. This, in turn, facilitates an optimization of joint geometry.

#### Increased knowledge implementable results and related cost reductions

The research in INNOTRACK has resulted in innovative methodologies to predict wheel-rail contact forces, plastic deformation, rolling contact fatigue (RCF) and wear of insulated joints.

The simulations have quantified contact forces at an insulated joint as functions of

the vehicle speed and joint dip, see Figure 5.3.4-1. From these simulations wear rate and rolling contact fatigue (RCF) damage have been predicted. Figure 5.3.4-2 shows the surface wear pattern at an insulated joint predicted by a new wear model derived in INNOTRACK. See section 5.3.3 for details. The numerical predictions match wear and RCF patterns found in operations.

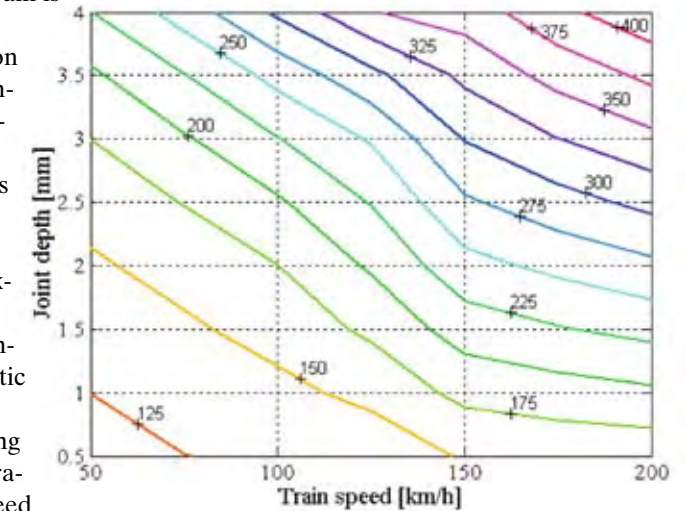

Figure 5.3.4-1: Influence of train speed and joint depth on the maximum wheel-rail contact force [kN] at an insulated joint.

The parametric influence of factors such as the width of the insulating layer, vertical and tractive load magnitudes and plastic deformations on plastic strain (RCF) has been established, see Tables 5.3.4-1 and 5.3.4-2. Further, the influence of rail edge bevelling on plastic deformation and rcf formation has been assessed and shown to be minor. These simulations have been supported by field observations of the gradual deterioration of an operational insulated joint.

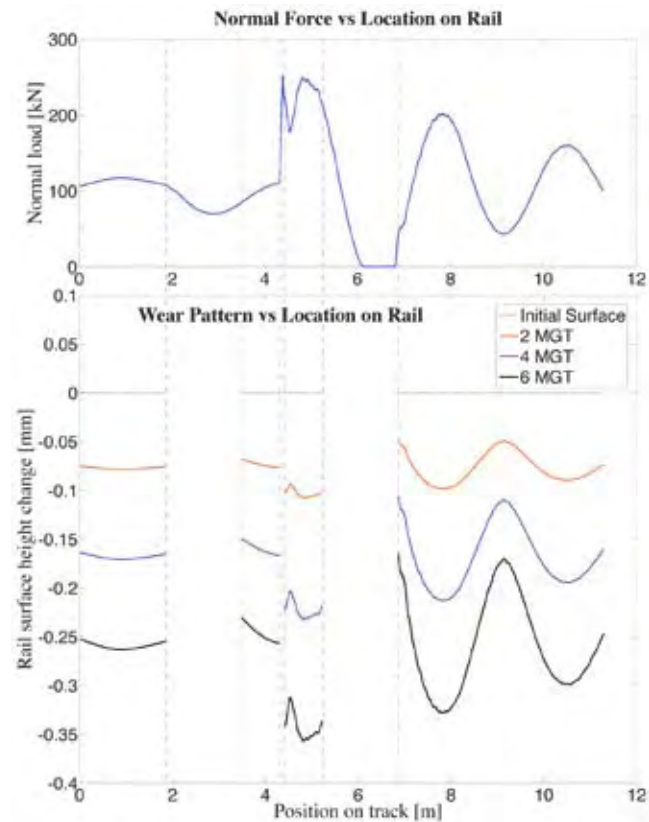

Figure 5.3.4-2: Top: Wheel-rail contact force variation as a wheel passes over a 3mm insulated joint at 125 kph (adopted from Elena Kabo, Jens C. O. Nielsen & Anders Ekberg, Prediction of dynamic train-track interaction and subsequent material deterioration in the presence of insulated rail joints, Vehicle System Dynamics, vol 44, pp. 718–729, 2006). Bottom: Corresponding wear pattern (worn rail surface) after 2, 4, and 6 MGT. Traction coefficient is 0.1. The gaps are regions where the contact patch ellipticity differs significantly from the 'standard' 1.32.

Insulating gap	4 mm	6 mm	8 mm
Vertical load 150 kN	2.47	2.67	2.84
Vertical load 200 kN	2.63	2.92	2.96

Table 5.3.4-1 Influence of vertical load magnitude and width of the insulating layer on plastic strain magnitudes. The traction coefficient is 0.2. See D4.2.3 appendix 1 for details.

Lateral force [kN]	-45	-30	0	30	45
Plastic strain [-]	3.2	2.4	2.2	2.5	4.1

Table 5.3.4-2 Influence of tractive load magnitude on plastic strain magnitudes. The width of the insulating layer is 4 mm and the vertical load 150 kN. See D4.2.3 appendix 1 for details.

In addition to the simulations on “standard” joints, simulations featuring a laterally inclined joint (see Figure 5.3.4-3) and simulations featuring a stiffer insulating material have also been carried out. The main conclusions were that no benefits from the inclined joint could be found, whereas a stiffer insulating material decreases the strain magnitude of the surrounding steel. However, this comes at the expense of higher interfacial shear stresses in the steel/insulation interface.

The results from INNTRACK are directly implementable in codes regarding design and maintenance tolerances of insulated

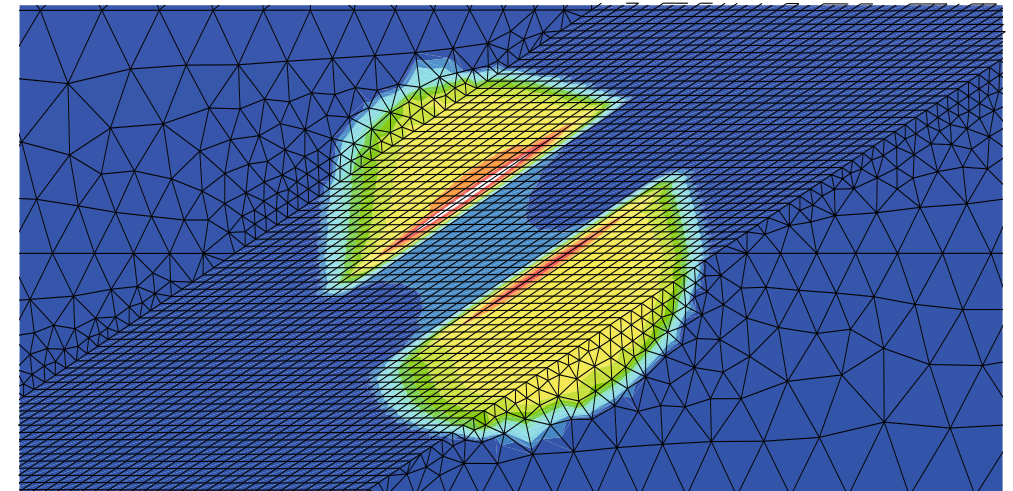

Figure 5.3.4-3: Contact pressure at an inclined insulated joint. The vertical load is  $F_y=150$  kN and the traction coefficient,  $f=0$ .

joints. As an example the research gives a good foundation for prescribing allowed joint dips. In addition, the influence of adjusting the width of the insulating layer and/or introduce rail edge bevelling can be quantified and compared to the risk that debris may bridge the insulating gap. Based on simulation results it is recommended that joint gaps be kept to a minimum where axle loads are high or where there are low lateral force magnitudes. At locations where lateral forces are high (or magnetic rail brakes are often used) the joint gap may be made larger to increase the reliability of the joint. This will however result in a lower overall life of the joint. To quantify the effects, a field test is currently underway in Sweden.

The INNTRACK results will allow an improved planning of maintenance of insulated joints. As an example, joints at locations where acceleration/braking of trains is common need to be more frequently inspected. Consequently, positioning such joints in these locations should be avoided, if possible.

Implementation of INNTRACK findings will result in LCC savings due to better (and possible diversified) design criteria, improved maintenance criteria, optimised (and diversified) inspection intervals, and

a shift towards planned maintenance. Implementation in Banverket will be used to confirm the estimated cost saving.

#### Open questions

The gain in knowledge, prediction methodologies and improved operational guidelines from INNTRACK is a major step forward. To further improve predictions, there is a need for more detailed simulation models (in particular the dynamic load magnitudes and contact stress fields must be better captured), refined field studies, cost evaluations and better methods of comparison among these. There are also questions that have not been explicitly addressed in INNTRACK, such as the influence of magnetic brakes, improved methods of reparation, etc.

#### References

1. INNTRACK Deliverable D4.2.1, The impact of vertical train-track interaction on rail and joint degradation, 22 pp (and 10 annexes, 27+25+10+12+6+8+7+7+25+4 pp), 2007
2. INNTRACK Deliverable D4.2.3 Improved model for loading and subsequent deterioration of insulated joints, 19 pp (and 1 annex, 17 pp), 2009
3. INNTRACK Deliverable D4.2.6, Recommendation of, and scientific basis for minimum action rules and maintenance limits, 126 pp (and 6 annexes, 9+8+10+9+10+33 pp), 2009

## 5.3.5 Growth of small cracks

Francis J. Franklin, Newcastle University; David I. Fletcher, Sheffield University  
More information is available in Deliverable D4.2.5.

### Background

Surface-breaking cracks can be broadly categorized as follows. Initiating cracks have typically less than 2 mm surface length and less than 1 mm depth, and the propagation is driven by the accumulation of plastic shear strain in the material near the rail surface. For short cracks, between about 0.5 mm and 10 mm below the surface, propagation is driven primarily by the contact stresses and is relatively slow. For long cracks, rail bending drives crack propagation, which can be extremely rapid, and can lead to rail breaks. If the wear rate is high enough, or if the rails are ground sufficiently, cracks will not grow to this dangerous phase. Prediction of short crack growth can therefore be used to optimize rail grinding operations and increase rail life and safety.

### Increased knowledge, implementable results and related cost reductions

In INNOTRACK the effect of out-of-round (OOR) wheels on short crack growth was studied using the Green's-function-based '2.5D' model. The contact pressure of a passing wheel was varied sinusoidally relative to the crack to represent the force variation caused by out of roundness. The wavelength was varied in the study. For wavelengths less than about 2 mm, the maximum force dominates crack growth – the standard model of crack propagation, without pressure variation, can be used with the maximum force. For wavelengths greater than about 20 mm, the standard model can again be used, but with variation of pressure between individual wheel passes. Between these extremes, pressure variation during the wheel pass is required for accurate modelling. In all cases, OOR

wheels accelerate short crack propagation; in contrast, for longer wavelengths at least, the predicted wear rate was not affected by OOR.

This study has therefore identified the conditions for including OOR wheels in the short crack propagation model. This model can be integrated with vehicle dynamics / multi-body simulations to assist rail life prediction.

The model can be used to optimize grinding schedules to increase rail life and safety, and to reduce associated costs.

### Open questions

Further study is required to identify (a) the effect on crack propagation of OOR features with wavelengths between 2mm and 20mm; and (b) the effect on wear rate of wavelengths below 20 mm.

### References

1. INNOTRACK Deliverable D4.2.5, Improved model for the influence of vehicle conditions (wheel flats, speed, axle load) on the loading and subsequent deterioration of rails, 47 pp (and 6 annexes, 48+14+9+22+35+51 pp), 2009

## 5.3.6 Large cracks – growth and fracture

Anders Ekberg, Jens Nielsen and Elena Kabo, Chalmers  
More information is available in Deliverables D4.2.1, D4.2.5 and D4.2.6.

### Background

The purpose of the INNOTRACK study was to establish a scientific foundation for regulations regarding permissible impact loads generated by wheel flats and pertinent maintenance practices. Current wheel removal criteria normally relate the alarm limit to the size (length) of a wheel flat. This is not an optimal situation, partly because of worker's safety: it may be both difficult and dangerous to locate and measure the length of a wheel flat during operations. However, there is also a profound scientific argument against such criteria: a wheel flat of a given size will result in different impact load magnitudes depending on, among other things, the type of vehicle, train speed, axle load and track properties. In the current study, operations of heavy haul (30 tonnes, 60 km/h), high-speed freight (25 tonnes, 100 km/h) and passengers (21.4 tonnes, 200 km/h) have been studied. Transversally propagated head check cracks and rail foot cracks have also been considered.

The aim was to base the wheel removal criterion on wheel-rail contact forces,

which can be measured by detectors. The study specifically targets the question of how the "severity" of an impact load of a certain magnitude should be quantified. In the current study, this is related to the risk of rail breaks.

An overview of current regulations regarding rail cracks is given in D4.2.6. These differ significantly between countries throughout Europe.

### Increased knowledge, implementable results and related cost reductions

Field observations have been employed to express the shape of a typical operational wheel flat mathematically. By numerical analysis and field measurements, the impact induced by a typical wheel flat has been translated to a parameterized impact force history. Vehicle and track dependent "worst case wheel flat impact force evolutions" have then been evaluated from a factorial design process. These also account for the wheel flat impact position. The corresponding time history of the rail bending moment has been evaluated

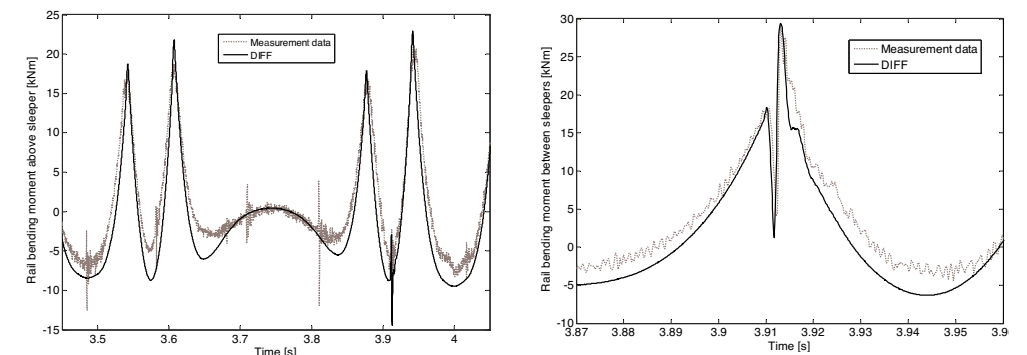

Figure 5.3.6-1: Left: Measured (dotted line) and calculated (solid line) bending moments in the rail above a sleeper located 1.5 sleeper distances away from the impact position of the wheel flat. In the model, wheel flat impact was only applied at 3.91 s. Right: Measured (dotted line) and calculated (solid line) bending moment in a sleeper span during wheel flat impact. From [4].

and quantified for operational conditions featuring variations in ballast stiffness, see Figure 5.3.6-1. The rail bending moment is considered as the driving force for the selected cracks.

To quantify the loading of a rail crack, stress intensity factors ( $K_I$ ) have been derived for head check cracks in 60E1 and 50E3 rails subjected to bending and tension. For rail foot cracks, handbook solutions have been employed. Comparing  $K_I$  to the fracture toughness ( $K_{IC}$ ) for different operational conditions gives the risk for rail breaks, see Figure 5.3.6-2.

Rail crack growth has been evaluated using Paris law. It was found that the influence of wheel flats on overall crack growth rates is low. This is due to the fact that wheel flats occur only on a small portion of the wheels and the resulting magnitude is very dependent on the impact position. Consequently, only some wheel flats will give an increased  $K_I$  (as compared to a non-flatted wheel) for a studied crack. Based on this, crack growth predictions have been carried out on the presumption of a constant wheel load.

A temperature below the stress free temperature will induce a (quasi-) static tensile stress, which will promote both crack growth and the risk of rail breaks, see Figure 5.3.6-3. This influence has been quantified in the study.

Altered ballast stiffness will influence the bending moments in the rail. In general, lower ballast stiffness will increase the nominal bending moment (and thus crack growth rates). This effect is more pronounced for heavy haul traffic. Regarding bending moments due to a wheel flat impact, the effect will depend on the operational conditions and lower ballast stiffness does not necessarily result in higher bending moments (implying a higher risk of rail breaks). The influence has been quantified in the study.

Also the influence of hanging sleeper(s) has been investigated. In general hanging sleepers will remove the beneficial effect

of high ballast stiffness and should be avoided. In particular this seems to be the case for high-speed operations (200 km/h in the current study). The influence has been quantified in the study.

The major potential cost reductions for the work in INNTRACK comes from

- Much more precise analysis of the influence of wheel flats. This allows for optimized alarm limits with respect to the number of stopped trains versus the risk for rail breaks. Factors such as track conditions and ambient temperatures can also be accounted for.
- Means to plan inspections and maintenance based on actual crack growth rates accounting for effects of varying operational conditions on different tracks.

The results from INNTRACK are directly implementable in codes and regulations. A framework for supplementary and/or more detailed simulations has been developed.

### Open questions

The crack growth simulations currently do not consider any increased crack growth rate due to a positive mean stress (except from any related increase in  $\Delta K$ ), nor the acceleration in crack growth rate close to fracture.

The choice of initial crack size will highly influence the predicted number of cycles to fracture. If the prediction can start with shorter initial cracks, there would be major potential benefits. However this requires better control of operational conditions, inspection tolerances and simulation capabilities. INNTRACK has tackled several of the issues involved, so the situation may well improve.

To develop even more precise inspection intervals, the influence of unloaded wagons on crack growth rates should be established. In addition, a cycle-by-cycle integration of Paris law to account for varying load amplitudes will be needed.

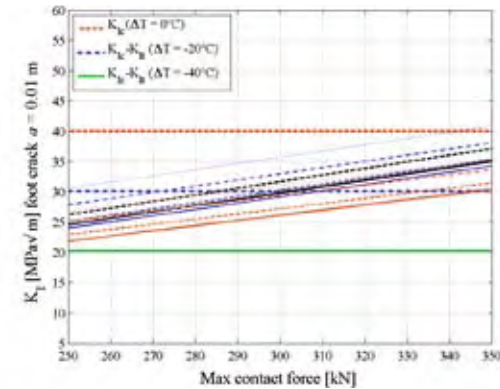

Figure 5.3.6-2: Stress intensities for a 10 mm 60E1 rail foot cracks due to impact loads of varying magnitudes. Vehicle type indicated by colour (heavy haul—black; freight—blue; passenger—red). Ballast stiffness indicated by line type ( $k_b=5\text{MN/m}$ —dotted;  $k_b=10\text{MN/m}$ —dashed-dot;  $k_b=30\text{MN/m}$ —dashed;  $k_b=100\text{MN/m}$ —solid). Fracture toughness reduced by thermal stress indicated by the horizontal lines. From [5].

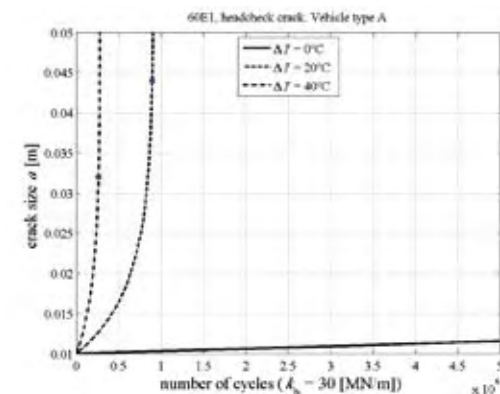

Figure 5.3.6-3: Influence of temperature (in terms of degrees centigrade below stress free temperature  $\Delta T$ ) on crack growth for 60E1 railhead cracks due to nominal wheel loads. Ballast stiffness per half sleeper  $k_b=30\text{MN/m}$ . Fracture marked by an x. Heavy haul vehicle. From [5].

### References

1. INNTRACK Deliverable D4.2.1, The impact of vertical train-track interaction on rail and joint degradation, 22 pp (and 10 annexes, 27+25+10+12+6+8+7+7+25+4 pp), 2007
2. INNTRACK Deliverable D4.2.5, Improved model for the influence of vehicle conditions (wheel flats, speed, axle load) on the loading and subsequent deterioration of rails, 47 pp (and 6 annexes, 48+14+9+22+35+51 pp), 2009
3. INNTRACK Deliverable D4.2.6, Recommendation of, and scientific basis for minimum action rules and maintenance limits, 126 pp (and 6 annexes, 9+8+10+9+10+33 pp), 2009
4. Jens C O Nielsen, Elena Kabo & Anders Ekberg, Alarm limits for wheel-rail impact loads – part 1: rail bending moments generated by wheel flats, Chalmers Applied Mechanics, Research report 2009:02, 35 pp, 2009
5. Anders Ekberg, Elena Kabo & Jens C O Nielsen, Alarm limits for wheel-rail impact loads – part 2: analysis of crack growth and fracture, Chalmers Applied Mechanics, Research report 2009:03, 53 pp, 2009.

## 5.3.7 Large cracks – probabilistic approach

Roger Allen, Corus

More information is available in Deliverable D4.2.2 and D4.2.6.

### Background

As mentioned above, the term ‘minimum action’ is used in a railway context to define actions that the engineer with responsibility for the safety of the line must take in the event that a defective or broken rail is discovered. Historically ‘Minimum Action’ rules have developed pragmatically. As a result, national practices reflect the historical experience of individual railway administrations. Unsurprisingly, this has resulted in a diversity of practices across Europe, see D4.2.6.

The objective of this part of the INNOTRACK project was to deliver guidance on the development, on a scientific basis, of ‘Minimum Action’ rules for the management of defective rails. To this end, software has been developed that enables the fraction of defective rails that will break to be predicted as a function of track and traffic characteristics, inspection capability and inspection periodicity, and to provide guidance on the timescales for remedial action. The approach combines fracture mechanics with Monte Carlo simulation and takes account not only of the stresses induced by traffic but also of the residual stresses and thermal stresses in the rail.

The fracture mechanics element of the modelling is specific to the type of defect concerned. For demonstration purposes therefore rail foot cracks were modelled. It is of particular interest in this context to determine how control limits for impact loads due to wheel irregularities will affect the breakage rate. For this application, a simplified model was developed to predict rail stresses due to impact loads.

### Increased knowledge, implementable results and related cost reductions

A software tool has been created and its potential demonstrated by application to rail foot defects. Figures 5.3.7-1 and 5.3.7-2 show the type of results that may be obtained. These results are for a particular traffic pattern and a specific probability of detection curve, and should only be taken as an indication of the type of results that can be obtained.

Fig. 5.3.7-1 shows how the proportion of defects that will be found before breakage occurs varies as a function of the inspection period. In this instance it will be seen that whilst very frequent inspection does reduce the breakage risk, the risk is still very high.

Fig. 5.3.7-2 shows the life to breakage distribution for defects that are detected, in this instance for the case of a 14 day inspection cycle. It is this residual life distribution that logically defines the timescale within which action must be taken.

The average life to failure is about 160 days, but to delay action for this length of time, knowing that there was a 50% risk of breakage, would be unacceptable. This highlights one of the philosophical problems in this type of work, namely ‘what is an acceptable breakage risk?’.

The public regards the railway as a ‘safe’ system of transport; hence to them, and to politicians, no level of risk is acceptable. If, as a result of applying a scientific approach, changes are proposed, then if there is no such thing as an ‘acceptable level of risk’, it must be demonstrated that what is proposed is at least as safe as current practice and preferably offers a reduction in risk, as well as economic benefit.

For similar reasons this should not only be seen as a tool that enables cost savings to be made but rather a tool that enables the cost benefits of a rail inspection/ minimum actions framework to be optimised.

### Open questions

Monte Carlo simulation is an extremely flexible and powerful tool but its application in this context relies on the ability to predict the growth rate of a crack under defined conditions. In other words, a reliable crack growth model is an essential pre-requisite. For the time being, and despite intensive research, this precludes the application of the model to the early stages of rolling contact fatigue crack growth. The results presented in D4.2.6 however provide a foundation for modelling the later stages of corner crack development in the railhead.

The model enables the effect of track and traffic changes as well as of the inspection and action regime to be evaluated but in the case of track or traffic changes, it has its limitations. For example, if an increase in axle load were proposed, the model would enable the effect on the fraction of defects resulting in breakage to be predicted, and would also output the residual life distribution of the detected

defects. However the effect of the change, in terms of the total number of defects initiating, would not be predicted. That is a separate problem but there is no fundamental reason why the Monte Carlo simulation approach could not be used to address it.

The model assumes an initially small defect, one below the threshold of detection. It is therefore not applicable to large, manufacturing induced defects. Whilst such defects are no longer a concern in plain rail, they remain a concern in aluminothermic welds because of the operator sensitivity of the welding process. Pragmatically, the historic approach has been to clamp suspect welds, and so control the breakage risk, and to concentrate on process development and welder training. This would still seem a better way forward.

### References

1. INNOTRACK Deliverable D4.2.2, Interim report on “Minimum Action” rules for selected defect types, 22 pp (and 4 annexes, 7+1+1+3 pp), 2007
2. INNOTRACK Deliverable D4.2.6, Recommendation of, and scientific basis for minimum action rules and maintenance limits, 126 pp (and 6 annexes, 9+8+10+9+10+33 pp), 2009

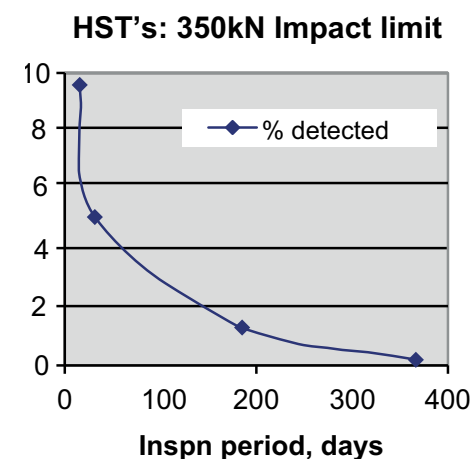

Figure 5.3.7-1: Fraction of defects detected as a function of inspection period

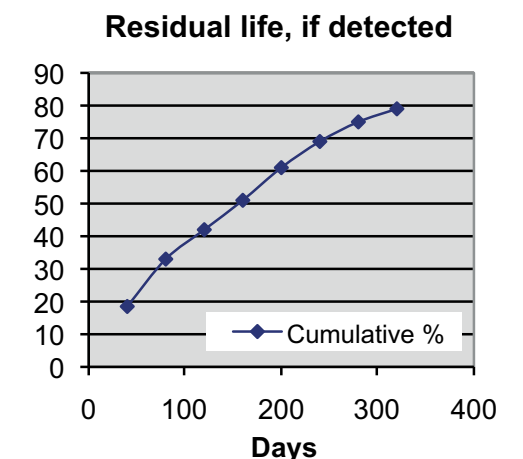

Figure 5.3.7-2: Residual life distribution of rails with detected defects: annual inspection



## 5.4 Rail testing

The aim of the work on rail testing in INNOTRACK had several objectives. The first was to develop innovative means of testing. The second was to be able to relate results from different means of testing to each other and towards operational conditions. To this end, several objectives need to be met. Firstly the test results need to be reported in a stringent and standardized manner to facilitate comparisons.

Secondly there is a need for numerical simulations and damage criteria that can compare the various conditions in different test set-ups and for different operational scenarios. Thirdly, there is a need to objectively characterize the resulting damage induced by the different tests and occurring in operational rails. This section will describe how these objectives were met.

### 5.4.1 Laboratory testing of rails

Detlev Ullrich, DB and Richard Stock, voestalpine  
For more details, see D4.3.7, D4.3.8

#### Background

Laboratory tests of rail materials may help railway operators as well as rail manufacturers to save time and money. If the tests represent operational conditions for the rail material, they will allow the withdrawing of less useful products from expensive field tests.

Usual test rigs are twin disk rigs with simple cylindrical geometry, or specialized full-scale test rigs, which in addition consider the influence of wheel and rail profiles. Within INNOTRACK WP4.3, the University of Newcastle supplied twin disk tests while voestalpine and DB provided their full-scale wheel-rail test rigs, using linear rail movement and a roller construction, respectively (see Figure 5.4.1-1)

The studies in INNOTRACK were aimed at establishing whether laboratory tests were able to simulate operational conditions with respect to wear, rolling contact fatigue (RCF), and material deformation. To this end, a matrix of tests involving different rail grades were carried out and a consistent evaluation scheme for the tests results was adopted.

#### Increased knowledge, implementable results and related cost reductions

For all laboratory tests, it is necessary to establish a testing matrix for preliminary planning. The matrix must take into account the specific rail geometry (curvature, etc.), the loads, wheel and rail profiles, etc. with respect to the specific operational conditions. A predefined scheme for the subsequent evaluation of the test results is also necessary. The work in INNOTRACK was undertaken accordingly.

Regarding the twin disk tests, the following results were established:

- The twin disk tests were able to quantify wear and RCF of different rail steels under controlled conditions. Trends such as the decrease of wear and RCF with increasing strength were established (see Figure 5.4.1-2).
- The tests are restricted to rather simple cylindrical contact conditions without any lateral forces or lateral slip. Hertzian contact calculations allow the definition of equivalent conditions. Lubrication, especially wetness plays an important role for the amount of rail wear and RCF.



Figure 5.4.1-1: Left: twin disk test rig (SUROS), right: linear test rig (VAS)

Regarding full-scale tests, the following results were established:

- The tests at the linear full-scale rig were able to prove that an increased wear resistance comes along with an increased RCF resistance of pearlitic rail steels. With increasing rail hardness, the distance between the RCF cracks on the surface is reduced. This corresponds to the existing experience.
- Differences between real track conditions and the test rig could be identified, particularly with reference to the influence of the friction coefficient and deviations from the expected contact angles due to bending of the rig.
- Tests on full-scale roller rigs with formed rail head material finally failed because of excessive demands on the forming and fixing of the rail. These tests appear to be too expensive for practical testing of rails.
- Subsequent numerical analysis of the tests regarding the worn profiles, friction etc. may confirm the compliance with the operational contact conditions.

#### Open questions

- Realistic conditions regarding the friction coefficient must be introduced in laboratory testing. This also holds for the definition of standard test situations such as heavy load, high speed, sharp curves, etc.
- More time efficient tests and reduced costs are required for full-scale tests in order to achieve a higher practical use.
- There is a need for test methods, which provide realistic data as an input for the numerical simulation of wear and RCF.

The Electron backscatter diffraction (EBSD) method may provide an early evaluation of different tested rail materials with respect to RCF.

#### References

1. INNTRACK Deliverable D4.3.7, Innovative laboratory tests for rail steels – Final report, 26 pp (and 1 annex, 5 pp), 2009
2. INNTRACK Deliverable D4.3.8, Innovative laboratory tests for rail steels, 19 pp (and 1 annex, 6 pp), 2009

## 5.4.2 Evaluation of contact stresses under laboratory test conditions

Zili Li, TU Delft

More information is available in Deliverables D4.3.4 and D4.3.7.

#### Background

Work was carried out in INNTRACK to compare the contact stress distributions of different rail-wheel test configurations (twin-disc and full-scale tests) between each other and towards field conditions. In particular, the work focused on the evaluation of the stress distributions for the occurrence of surface initiated Rolling Contact Fatigue Cracks such as head checks (HC) and gauge corner cracks.

The study deals with three test rigs: DB's full-scale roller rig, voestalpine's full-scale linear test rig, and the SUROS twin-disc rig. Table 5.4.2-1 shows evaluated maximum shear stress magnitudes, their locations and the identified rail inclination. Figure 5.4.2-1 shows an example of theoretically evaluated shear stress magnitudes and the direction of the shear stress vector at the rail surface.

#### Increased knowledge, implementable results, and related cost reductions

The calculation of the stress of frictional rolling contact was performed under the presumption of static contact and an elastic material response. This approach is justified by initiation and growth of HC being a (quasi-) static phenomenon in the sense of contact mechanics. Elasticity is applicable since HC initiates only after thousands of wheel/rail contacts, so that for each contact the component of the plastic strain is small compared to the elastic component.

The developed method combines the solution of frictional rolling contact with relative wheelset-track motion. Lateral wheelset displacement relative to the track, angle of attack, kinematic spin and, in particular, the geometrical spin due to

varying contact angle in the contact area can automatically be taken into account.

Cracks are not included in the stress calculations and hence the model is only applicable for HC initiation. It is considered that HC initiates due to shear deformation. In addition shear stress, together with possible micro-slip, may cause wear. Hence, it is not necessary that the place with the highest shear stress will be the location of HC initiation, e.g. at the gauge face, where the wear rate may be high enough to suppress HC. Bearing in mind that the purpose of the stress assessment here is intended for comparison of stresses of HC initiation under different lab loading conditions, the shear stresses are assessed at locations where HC may initiate, but not necessarily where the shear stress is the highest.

The predictions of contact stresses and the corresponding location of HC initiation that has been carried out within INNTRACK has led to the following findings and conclusions:

- A non-Hertzian approach is developed for the solution of general wheel-rail frictional rolling contact. Multiple point contact and conformal contact can be handled. It is shown that, generally speaking, non-Hertzian evaluations should be employed for higher accuracy.
- The presented method can identify the deviation of the actual loading configuration with respect to the nominal configuration of the test set-up. It can thus take such a deviation into account in the stress calculation.
- Influence of wear on HC initiation and growth can be taken into consideration for the determination of the location and corresponding stresses corresponding to HC initiation.

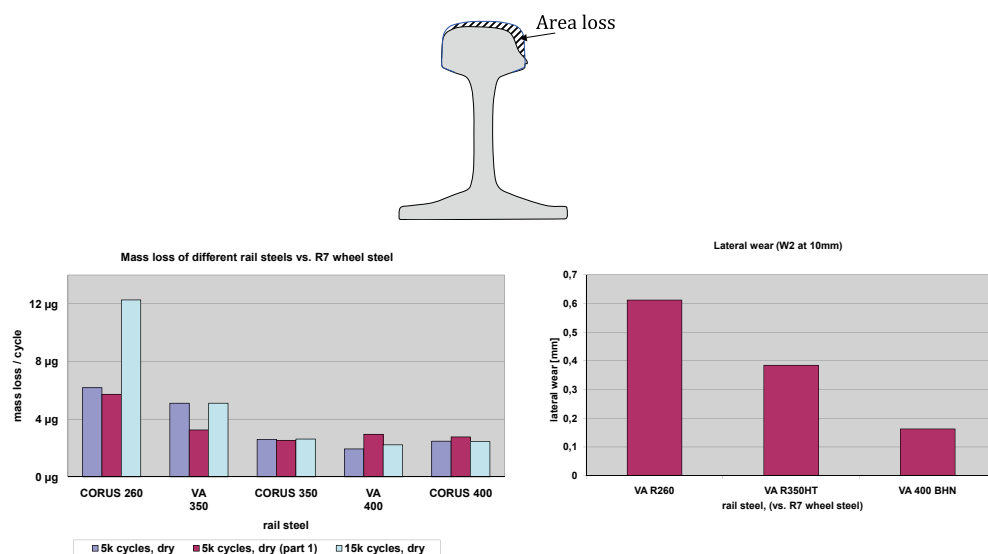

Figure 5.4.1-2: Wear rates, depending on the steel grade Left: twin disk tests, right VAS linear rig

The results from INNTRACK form a major first step forward in unifying laboratory tests with field observations and operational predictions of head checks. In addition, the identified parametric sensitivities can be used to improve laboratory testing. This work is already in progress in the updating of the voestalpine test rig.

#### Open questions

- The coefficient of friction (COF) was not measured in DB's and voestalpine's full scale rigs. Consequently, the interfacial shear stress could only be calculated based on an estimated COF. It is recommended that the COF be measured in such laboratory rig tests in the future.
- The method for calculation of contact stress is based on continuum mecha-

tics. No cracks have been accounted for. It is therefore, rigorously speaking, applicable only to crack initiation. Other methods such as the finite element method should be employed for evaluation of stresses for bodies with cracks in the vicinity of the contact.

#### References

1. INNTRACK Deliverable D4.3.4, Calculation of contact stresses for laboratory test rigs, 23 pp (and 5 annexes, 6+7+30+27+4 pp), 2009
2. INNTRACK Deliverable D4.3.7, Innovative laboratory tests for rail steels – Final report, 26 pp (and 1 annex, 5 pp), 2009

	UoN SUROS	VAS WET 1	DB rig C
Max. shear stress	0.675 GPa ( $\mu = 0.45$ )	0.59–1.0 GPa ( $\mu = 0.45$ )	0.75–0.83 GPa ( $\mu = 0.2$ ) 0.41–0.47 GPa ( $\mu = 0.1$ )
Location of max shear stress	Across the cylindrical surface	3–11 mm from inner rail side	Broad area, 10–36 mm from inner rail side
Kind of contact	Line contact	1- or 2-points	1- or 2-points or multiple contact
inclination, design	–	1:40	1:40
inclination, ascertained by simulation	–	1:172	~1:100

Table 5.4.2-1: Evaluated shear stress magnitudes, locations of maximum shear stress for HC initiation, and identified rail inclination.

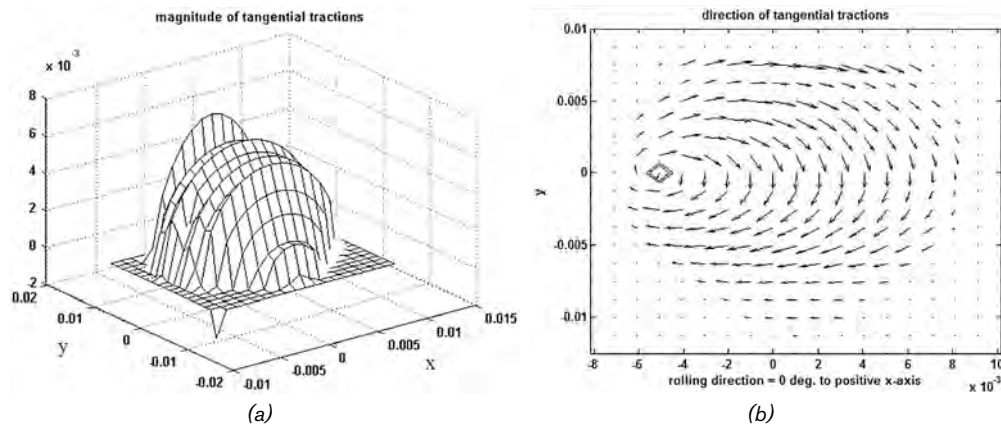

Figure 5.4.2-1: Example of (a) theoretically evaluated shear stress and (b) shear stress direction

### 5.4.3 Prediction of rolling contact fatigue (RCF) from laboratory tests

Elena Kabo and Anders Ekberg, Chalmers

More information is available in Deliverables D4.3.5 and D4.3.7.

#### Background

Work was carried out in INNTRACK to compare different rail-wheel test configurations (twin-disc and full-scale tests) between each other and with field conditions. In particular the comparison focused on predicting the occurrence of surface initiated rolling contact fatigue (RCF), thereby making it possible to relate the configurations by comparing predicted number of load passes to RCF initiation.

The study compares results from three test rigs: DB's and voestalpine's full scale rigs and the SUROS twin-disc rig. The analysis uses test data and the contact analysis presented in section 5.4.2.

#### Increased knowledge, implementable results and related cost reductions

A fatigue index,  $FI_{surf}$  based on the shake-down map was employed to quantify the surface initiated RCF impact. The fatigue index  $FI_{surf}$  was employed under the presumption of full slip at measured/estimated levels of maximum coefficient of friction. Further, contact patch sizes were taken from non-Hertzian contact analyses as presented in section 5.4.2.

Under these conditions  $FI_{surf}$  gave promising results in that a log-log-plot of  $FI_{surf}$  magnitudes versus measured fatigue lives showed a trend that is physically sound and can be expressed by a Wöhler-like relationship:  $FI_{surf} = A(N_f)^B$

Here  $N_f$  is the fatigue life and  $A$  and  $B$  material parameters.

In Figure 5.4.3-1 estimated  $FI_{surf}$  magnitudes (for high and low estimations of the coefficient of friction) are plotted against measured fatigue lives. A Wöhler curve with  $A = 1.78$  and  $B = -0.25$  is indicated as a grey line.

An additional analysis was carried out from elasto-plastic FE-simulations featuring a non-linear hardening model optimized towards laboratory tests of the rail steel material. Examples of results are shown in Figure 5.4.3-2.

The simulations and predictions of surface initiated RCF that have been carried out within INNTRACK have led to several important conclusions:

- A tentative relation to establish fatigue life from evaluated fatigue indices has been derived as shown above. This relation can be used as a first estimation to compare laboratory tests towards each other and towards operational conditions, which was the main goal of the study.
- The conformal contact in some tests makes numerical evaluations complicated. As an example multi-body simulations of wheel-rail interaction were carried out to test the presumption of full slip conditions. However, with conformal contact, the interpretation of simulation results was not straightforward due to their sensitivity to wheel and rail profile shapes. The same sensitivity was found in the FE-simulations where a small tractive load altered the resulting contact stress field significantly. Note that this sensitivity is not a deficiency in the numerical models, but rather a reflection of the "reality".
- The FE-simulations are on the limit of what commercial codes currently can manage.

The results from INNTRACK form a major first step forward in unifying laboratory tests with field observations and operational predictions of surface initiated rolling contact fatigue. In addition, the

identified needs regarding input parameters and handling of parametric sensitivities can be used to improve laboratory testing. This work is already in progress in the updating of the voestalpine test rig.

#### Open questions

- The use of  $FI_{surf}$  should be confined to cases of full slip. For other operational conditions, other indices (or a revised  $FI_{surf}$ ) are likely to be needed. Further, more test cases are needed to establish the fatigue life relationship more precisely.
- There is a need for improved means and methods to gather more exact input data and to harmonize measured quantities with parameters employed in the numerical simulations. Further, also the test conditions may need to be revised if more precise simulations should be performed. As an example, variable load magnitudes make FE-simulations much more demanding.
- The influence of lubrication (in the crack initiation and crack propagation phases) needs to be handled in a more stringent manner.
- FE-codes need to be better in dealing with the combination of very high local deformations in connection to large displacements, high contact pressures and interfacial shear stresses, conformal contact and sophisticated constitutive models.
- Since it will not be possible to simulate global dynamic train-track interaction with detailed FE-models, there is a need to translate results/predictions from the FE-simulations to more “engineering-type” models.

#### References

1. INNTRACK Deliverable D4.3.5, Simulation of material deformation and RCF, 43 pp (and 2 annexes, 20+17 pp), 2009
2. INNTRACK Deliverable D4.3.7, Innovative laboratory tests for rail steels – Final report, 26 pp (and 1 annex, 5 pp), 2009
3. INNTRACK Deliverable D4.3.8, Innovative laboratory tests for rail steels, 19 pp (and 1 annex, 6 pp), 2009

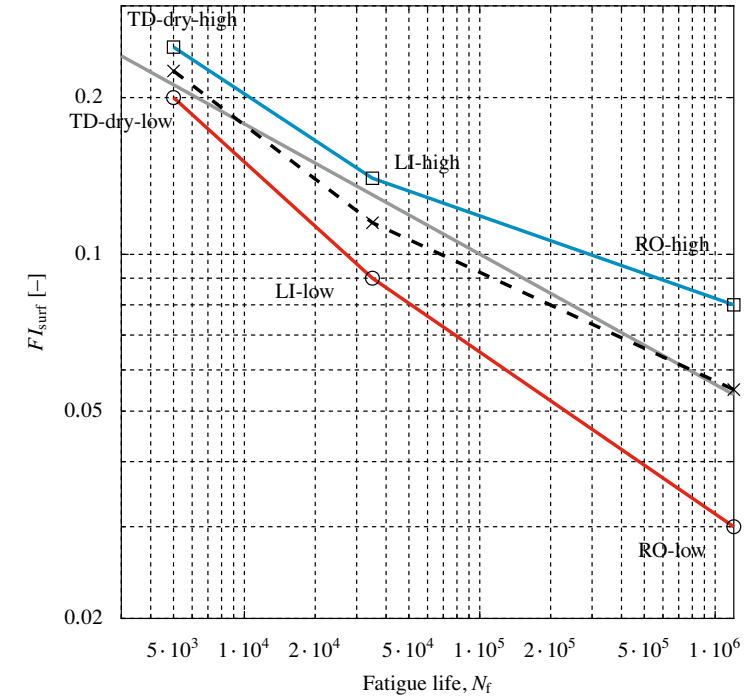

Figure 5.4.3-1: Theoretically evaluated fatigue index  $FI_{surf}$  plotted against measured rolling contact fatigue initiation lives for three different test rigs.

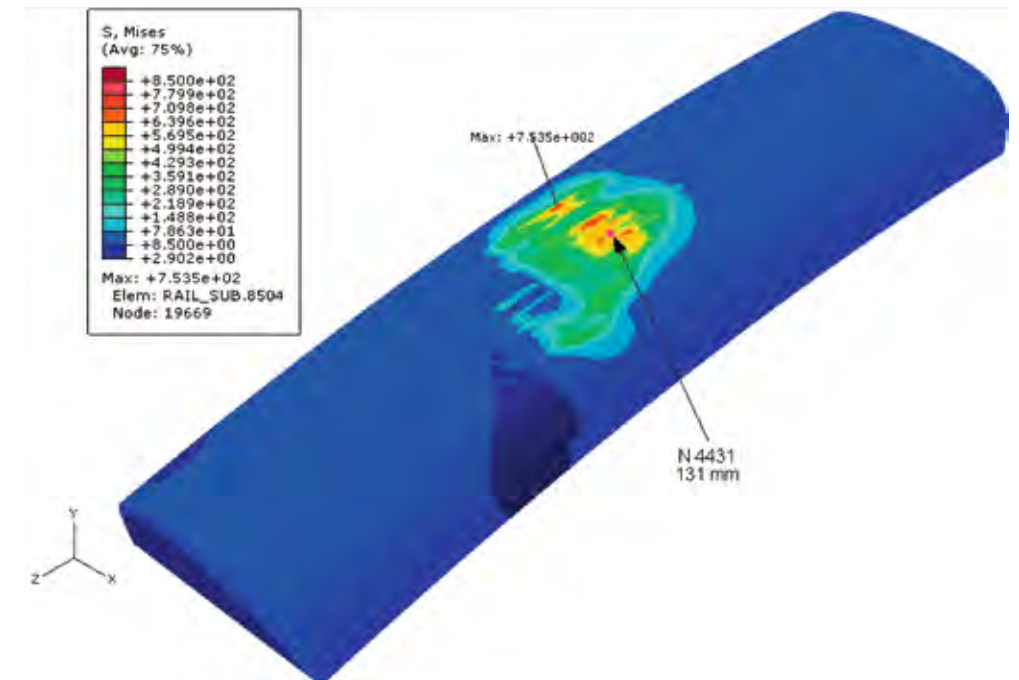

Figure 5.4.3-2: FE-simulation of the DB test rig. Von Mises stress evaluated during the fifth load passage.

## 5.4.4 Characterisation of microstructural deformation as a function of rail grade

Jay Jaiswal, Corus

More information is available in Deliverables D4.1.5, D4.3.2 and D4.3.6.

### Background

In recent years, a very significant volume of work and research resources have been devoted to the study of wheel rail contact conditions through numerical and vehicle dynamic simulations. The improved understanding has enabled the determination of optimum wheel and rail profiles and improved vehicle designs to reduce the imposed stresses and thereby make a welcome contribution towards increasing rail life. However, a parallel and equally important avenue of research is to establish the metallurgical properties of the rail that would make it more resistant to the prevailing degradation mechanisms. It is this metallurgical context that made it necessary to establish an objective methodology for assessing microstructural damage caused by passing vehicles. It should also be recognised that although a measure of the energy input in the contact patch has given encouraging correlation with observed rolling contact fatigue (RCF) damage, it is an empirical approach that

does not provide any guidance for the development of more damage resistant rail grades. Furthermore, knowledge of the true depth of damage from the running surface is beneficial for the determination of the magnitude of metal removal that may be necessary to restore the undamaged original microstructure.

Although research by rail manufacturers has led to the development of a wide range of rail grades, their adoption by the infrastructure managers has been slow and limited. It is, therefore, imperative that the comparative benefits of the use of the available rail steels are established scientifically to enable their use under the appropriate duty conditions to minimise life cycle costs of track maintenance. The assessment of the level of susceptibility to microstructural damage of the various rail grades under similar duty conditions is considered desirable to establish the guidelines for the optimum selection of the available rail steels.



Deformed microstructures

Figure 5.4.4-1: Trafficked grade R220 rail



Figure 5.4.4-2: R260 Grade steel after 5000 dry + 5000 wet cycles in twin disc test

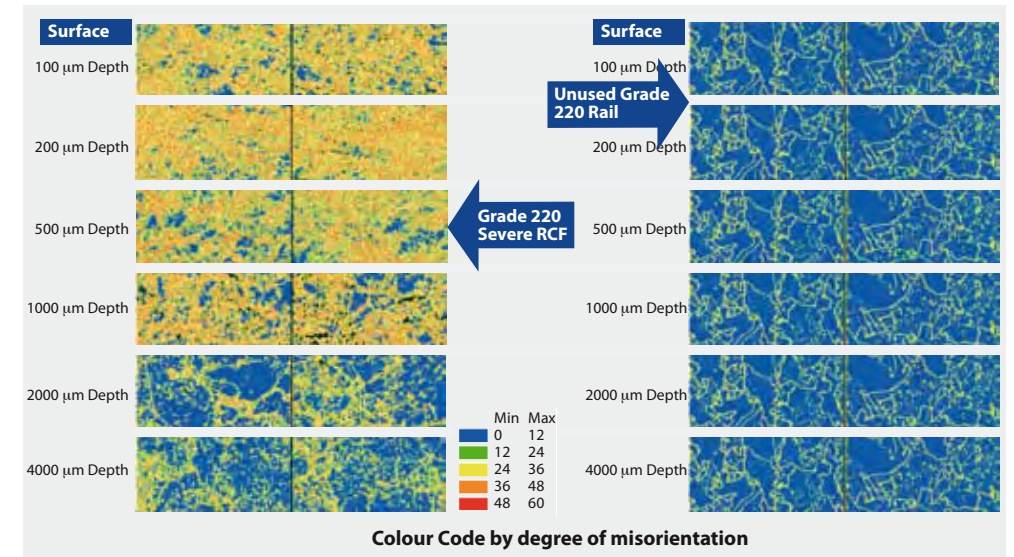

Figure 5.4.4-3: Comparison of grade 220 rails in untrafficked and trafficked conditions using EBSD

### Increased knowledge, implementable results and related cost reductions

Electron Back Scatter Diffraction (EBSD) technique has been applied in a novel manner for the assessment of microstructural misorientation that results from the stresses imposed by rail-wheel contact. The misorientation is quantified by Kernal Average Misorientation (KAM) values. Key conclusions from the work reported are:

1. Using control samples of **unused** rail, it has been shown that the degree of misorientation measured by EBSD technique is minimal from the surface to the measured maximum depth of 5mm. Since hot rolled rails undergo high temperature static recrystallisation immediately after rolling, the minimal microstructural misorientation measured by the developed EBSD technique demonstrates the validity of the technique. In the case of **unused** heat treated rails, the degree of the measured damage is slightly higher than that for as rolled non-heat treated grades, which is probably a reflection of the finer pearlitic microstructure. Consequently, EBSD analysis has been shown to be a credible technique to determine the magnitude of microstructural mis-

orientation and its use for assessing the magnitude of “microstructural damage” from the passage of traffic. The proposed technique is the only direct and objective measure of accumulated damage imparted by wheel-rail interaction and is far more discriminating than the currently used technique of microhardness measurements.

2. The most important finding of this work is the determination of the depth at which the microstructural misorientation in trafficked samples reaches that of unused rail i.e. the depth of the damaged layer, cf. Figures 5.4.4-1 to 5.4.4-5 and Table 5.4.4-1. The values indicate a decreasing depth of “damaged layer” with increasing hardness of the rail with R370CRHT and R400HT grade rails showing damage depths of <1mm. Clearly, the very limited depth of the “damaged layer” in the premium grade rail steels suggests that the damaged layer could be removed by light grinding to expose undeformed (“undamaged”) microstructure.
3. The assessment of samples from twin disk tests, employing an unusually large number (5000) of dry cycles, has also shown a decrease in depth of “damaged

Figure 5.4.4-4: EBSD KAM values as a function of depth for as rolled rail grades R220 and R260

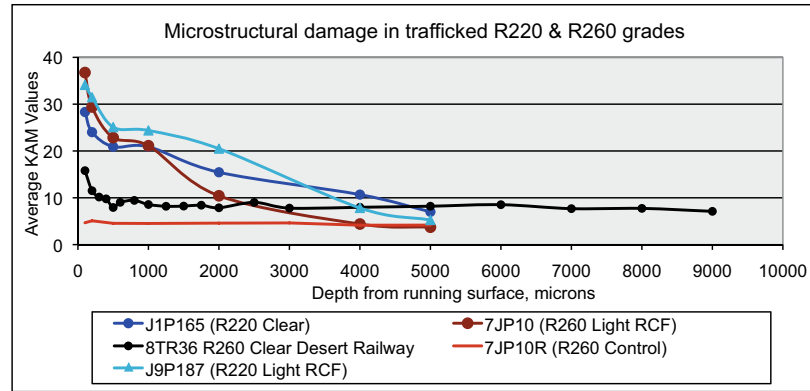
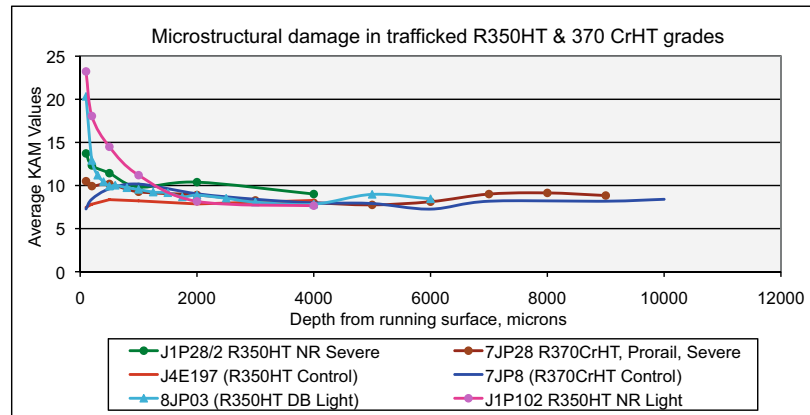

Figure 5.4.4-5: EBSD KAM values as a function of depth for rail grades R350HT and R370CrHT



layer” with increasing rail hardness. However the absolute magnitude of depths were significantly less than the corresponding figures for trafficked samples. This has been attributed to the removal of material as a result of the high wear during the dry cycles. A reduction in the number of dry cycles from 5000 to just 250 has given depths of “damaged layer” that are similar to those observed in trafficked samples and hence provide confidence in this simple test to provide reliable comparative properties for the various rail grades.

4. The microstructural deformation measured from the gauge corner of the test samples from the voestalpine roller rig reflects good correlation with trafficked samples. However, for all grades exami-

ned, the microstructural deformation from the top of the head locations was appreciably less and achieved the value of the control sample at a much shallower depths than those in trafficked rails of the corresponding grade.

5. Based on the assessment to date, it is concluded that microstructural deformation reflects the specific loading conditions and that the optimum selection of rail grades for the wide variety of loading conditions that exist on any railway network should be based on the performance of the rail grades under very closely controlled test conditions as undertaken in this programme. The rail grades in order of increasing resistance to microstructural deformation are: R220, R260, R350HT, with the highest resistance being

Track/Lab tests	R260		R350HT		R370CrHT	
	Max KAM	Depth of deformation	Max KAM	Depth of deformation	Max KAM	Depth of deformation
Track trafficked sample	37	5	20-23	2-3	9-10	1
SUROS 5000 dry + wet	42	0.8	26	0.3	42	0.1
Corus twin disc	26	>6	Not undertaken		9	1
DB rig A	28	1.5	Not undertaken			
DB rig C	23	1	Not undertaken			
voestalpine roller rig top of head	38	2	29	0.5	29	0.5
voestalpine roller rig gauge corner	38	6	30	2	27	0.8

Table 5.4.4-1: Comparison of EBSD analysis data Rail Grades

provided by R370CrHT and R400HT. The advantages that could be realised in the appropriate track locations are:

- Maintenance of the crown profile for a longer period of time to ensure the desired rail-wheel contact
- Increased proof strength to resist plastic deformation in a railway network designed for higher speed passenger traffic and increasingly being asked to carry more freight traffic at lower speeds.
- Increased resistance to the initiation of rolling contact fatigue as demonstrated by the laboratory tests and the INNOTRACK degradation models derived from a wide range of track trials
- The much lower depth of microstructural “damage” that can potentially be removed more effectively through single pass grinding at longer intervals.

The above knowledge of the resistance to microstructural deformation has been combined with rail degradation algorithms derived from extensive track trials to arrive at the guidelines for rail grade selection, see D4.1.5

#### Open questions

It is recommended that the work be extended to examine the effect of the magnitude of traffic on the depth of the “damaged layer” using controlled samples from track. Further research is also recommended to establish a correlation between the measured KAM values and the accumulated strain.

#### References

- INNOTRACK Deliverable D4.1.5, Definitive guidelines on the use of different rail grades, 45 pp, 2009
- INNOTRACK Deliverable D4.3.2, Characterisation of microstructural changes in surface & sub-surface layers of rails with traffic, 22 pp, 2007
- INNOTRACK Deliverable D4.3.6, Characterisation of microstructural deformation as a function of rail grade, 30 pp, 2009

## 5.4.5 Track tests/track monitoring

Albert Jörg, voestalpine

Track tests (track monitoring) are powerful tools in examining the degradation behaviour of rails and rail steels. The execution of a track test represents a win/win situation for industry and railway administrations as the generated information supports the further development of existing rail steels and the development of new rail grades, which will eventually benefit both. In addition, the collected data assist the infrastructure managers in establishing rail grade selection criteria and associated maintenance strategies.

For a detailed analysis of a track test, a large amount of information is required. This information should include general information and boundary condition for the operational conditions, as well as details on the degradation of the installed rails. Table 5.4.5-1 provides a compact overview on relevant information, which should be surveyed during a track test.

During the course of the INNOTRACK project, a database was created [1]. This database consists of data from more than 200 track tests performed by voestalpine and Corus together with European railways. The collected data were used for detailed analyses of the deterioration behavior of different rail grades. This analysis is the basis for the rail grade selection recommendations developed in INNOTRACK.

### References

1. INNOTRACK Deliverable D4.1.1, Interim database for actual and new, innovative rail/joints, 15 pp (and 1 annex, 91 pp), 2008

<b>General information</b>	
Exact location	
Test layout	installed rail grades, length of rails, position in the test layout, weldings
Date of installation	
<b>Track characteristics</b>	
Track alignment	radius, cant, track gradient
Components of the superstructure	(rails), sleepers, rail pads, ballast bed: types and properties
Substructure	properties (mainly elasticity)
<b>Loading characteristics</b>	
Type of traffic	mixed traffic, HS traffic, HH traffic etc.
Axle loads	axle load distributions, average axle loads, mean axle load
Train velocities	passenger trains (tilting trains), freight trains etc.
<b>Maintenance</b>	
Tamping actions	detailed information and exact dates
Rail grinding	detailed information and exact dates
<b>Rail degradation</b>	
Wear	measured wear and dates of measurement
RCF	measured RCF (surface length, crack depth) and dates of measurement
Plastic deformation	measured values and dates of measurements

Table 5.4.5-1: Overview on required data collection for track tests

## 5.5 Inspection and maintenance

In order to enforce efficient rail maintenance routines it is vital to detect rail damage as early as possible. In INNOTRACK rail cracks have been the focus. A review of the state-of-the-art in non-destructive testing was carried out, followed by further research and development of new techniques. Finally field trials of promising new techniques were carried out and the conclusions summarized.

Identified rail cracks need to be removed by grinding. INNOTRACK has strived towards optimizing the grinding procedure. This is a complex task that involves many considerations. There are technical issues, such as employed profiles and allowed tolerances, but to obtain an LCC optimised grinding process there is also a need to plan grinding in a strategic way and to optimise the logistics.

## 5.5.1 Detection of rolling contact fatigue in rails

Clive Roberts, University of Birmingham.

More information is available in deliverables D4.4.1, D4.4.2, and D4.4.3.

Within INNOTRACK research into non-destructive testing of rails was focussed on:

1. A review of the state-of-the-art in non-destructive testing for railway track and elicitation of requirements for further operational improvements (D4.4.1);
2. Further research and development of new techniques that have the potential to fulfil the identified operational requirements (D4.4.2).
3. Field trials of promising new techniques – Alternating Current Field Measurement (ACFM), Electromagnetic Acoustic Transducers (EMAT's) and visual systems (D4.4.3)

### Non-destructive testing for railway track

The rail industry commonly employs ultrasonic probes mounted on special test trains in order to inspect rails fast. The efficiency of these ultrasonic systems has been criticised for several years and the potential application of other technologies, such as eddy current (EC) probes, magnetic flux leakage (MFL) detectors, Alternating Current Field Measurement (ACFM) sensors and ultrasonic phased array probes, has been under investigation.

The main issue in rail inspection from the industrial point of view is to develop a method that will offer improved sensitivity to rolling contact fatigue (RCF) defects and higher resolution, preferably without any compromise in the speed of inspection currently achieved.

For several years the application of eddy current technology in the rail industry was limited to surface inspection of individual rail welds. Some eddy current systems were then developed to perform manual inspections in order to detect the presence of RCF damage and wheel burns on

the railhead surface. Typical eddy current sensors comprise of one exciting and one sensing coil. An alternating current is fed to the exciting coil in order to generate a magnetic field near the surface of the rail head. Changes in the magnetic field cause eddy currents to be induced just below the surface of the rail head. Changes in the secondary magnetic field generated by the eddy currents are detected by the search coil in the form of an induced voltage. If the inspected area is free of defects then the impedance of the eddy current sensor remains constant. However, when a near-surface or surface defect is present in the rail head, the eddy currents are disturbed causing fluctuations in the secondary magnetic field giving rise to changes in the impedance. Thus, during manual inspection for near-surface or surface damage of the rail head with eddy current systems the operator looks for any changes in the impedance signal recorded in order to detect the presence of defects.

In rail inspection with MFL, search coils positioned at a constant distance from the rail are used to detect any changes in the magnetic field that is generated by a DC electromagnet near the rail head. In the areas where a near-surface or surface transverse defect is present in the rail, ferromagnetic domains in the steel do not support the magnetic field flux and some flux leaks. The sensing coil detects a change in the magnetic field and the defect indication is recorded.

In addition to these detection techniques, manual inspections are carried out to precisely characterise in position and depth the defects previously detected. However, the characterisation methods currently used are not efficient in all cases

owing to important limitations. This is particularly the case for squat and head checking defects, which are difficult to size due to the defect features and the poor state of surface. The presence of shallow angled cracks to the surface for squat defects and multiple cracks spaced a few millimetres apart for head checking, induce a shadowing effect inside the rail head and can prevent accurate measurement of the depth of the cracks.

The ACFM technique is a non-contact electromagnetic inspection method which is now widely accepted as an alternative to magnetic particle inspection, both above and below water. The technique is based on the principle that an alternating current (AC) can be induced to flow in a thin skin near the surface of any conductor. By introducing a remote uniform current into an area of the component under test, when there are no defects present, the electrical current will be undisturbed. If a crack is present the uniform current is disturbed and the current flows around the ends and down the faces of the crack as shown in figure 5.5.1-1. Because the current is an alternating current it flows in a thin skin close to the surface and is unaffected by

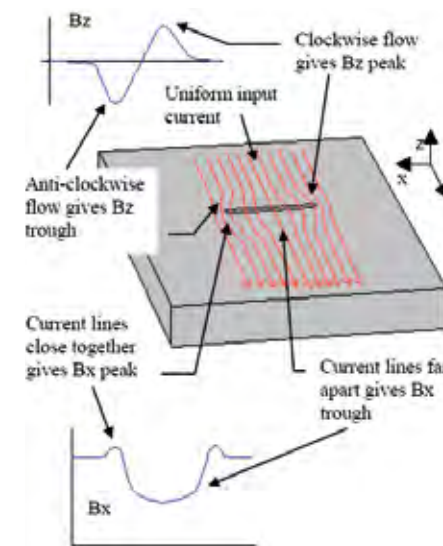

Figure 5.5.1-1: ACFM concept

the overall geometry of the component. In contrast to eddy current sensors that are required to be placed at a close (< 2mm) and constant distance from the inspected surface, a maximum operating lift-off of 5mm is possible without significant loss of signal when using ACFM probes.

Ultrasonic phased array techniques present many advantages including detection and evaluation of internal defects such as star cracking, foot corrosion etc. By transposing these techniques to rail inspection, it is possible to perform 3D-scanning while maintaining a coherent ultrasonic beam through the geometry of the inspected rail. Phased array techniques were carried out in the framework of INNOTRACK to evaluate the possibility to improve flaw characterization without considering inspection speeds.

### Field trials

Two rail sections, each approximately 20 m long, were inspected during field trials in Swindon UK. The first section was identified as containing light RCF cracks, while the second was identified as containing moderate RCF cracks during ultrasonic testing and visual inspection conducted by Network Rail. The tracks had been ground prior to the trials. The rail at the site was grade R220 (the rail branding identified the rail to be BS11: 1959 open hearth basic grade produced by Colvilles Ltd. in 1968).

As expected, a number of difficulties were encountered when taking equipment which had previously been lab based into the field for testing. The ACFM and EMAT approaches showed potential to identify and characterise RCF defects. The accuracy of the results was compromised, as only general data was available about the particular defects being inspected and the precision measurement location.

For ACFM, the inspection of the moderate RCF section showed that there were RCF cracks present with a similar but slightly denser distribution as compared to the light RCF rail section.



Although it is not currently possible to quantify the cracks detected from the results, it can be seen that the ACFM sensor was capable of successfully detecting the damage present on the rails. It is also possible to qualitatively determine the extent of the damage present on the rail sections inspected.

Further developments are underway to enable a more quantitative evaluation of RCF damage on rails using ACFM sensor technology. Further work will be undertaken in the FP7 funded INTERAIL project.

The testing of the image analysis trolley on mixed traffic railways demonstrated that:

- Deviations in running band and defects within it are readily observable from a trolley mounted camera;
- The presence of residual grinding marks makes it difficult to detect defects away from the running band;
- The image quality from the current camera systems is suboptimal, especially as it is unable to capture images at speeds of greater than 20 km/h;
- The current software is unable to detect defects within the running band but can detect the width of the running band.

To overcome these difficulties, Corus along with Manchester Metropolitan University is undertaking further work on image analysis of rails within the FP7 project PM 'n' IDEA. The development is concentrating on light rail and metro systems, but will ultimately be usable on mixed traffic systems. The improvements include:

- The use of a camera and lighting system that is able to give higher resolution images and be used at higher speeds. The camera will also be fitted to light rail vehicles to demonstrate the feasibility of using such systems in service;
- The development of software which is more intelligent than current versions. This will include using a range of image analysis techniques, rather than just edge

detection, to be able to look for a range of defects that are present in a range of orientations.

- Inspection of components, other than just the rail, within 0.5m of the centre of the rail head. This will make the system more comprehensive and will enable further automation of track inspection.

The results of this development will be reported when complete within the PM 'n' IDEA project.

The EMAT's data clearly shows that there appear to be regions where both the amplitude and high frequency content of the surface waves fall, which would be consistent with the presence of defects. No major falls in amplitude appear to have been recorded, suggesting that there are no very deep (>20 mm) defects in the sections of track that were tested.

Future work includes the construction of an array of detectors rather than the use of just one detector. This should increase the ability to detect cracks shorter than 10 mm in length. A new design of EMAT with lower noise susceptibility has been demonstrated and this design will be incorporated into future tests. When further tests are undertaken, a more quantitative measurement of the defects in the rail and their position will be required, together with an accurate measurement of position of where the data was recorded on the trolley based rig.

#### References

1. INNTRACK Deliverable D4.4.1, Rail inspection technologies, 43 pp, 2008
2. INNTRACK Deliverable D4.4.2, Operational evaluation of an inspection demonstrator (phase 1: laboratory and static tests), 94 pp (and 3 annexes 20+4+3 pp), 2009
3. INNTRACK Deliverable D4.4.3, Evaluation of an inspection demonstrator (phase 2: track tests), 25 pp, 2009

## 5.5.2 Grinding

René Heyder, DB

More information is available in deliverables D4.5.1, D4.5.2, D4.5.3 and D4.5.5.

### Background

Modern railway traffic operation provokes at many places (depending from local, operational conditions) a rail surface fatigue phenomenon, usually referred to as rolling contact fatigue, RCF. Head checks and similar defects develop sooner or later. The rail steel quality plays a determining role, but there is no material available at present, which can prevent the development of RCF cracks. Furthermore, the majority of rails in track today, with adequate but lower fatigue resistance, have a residual life span, which makes it much more economic to maintain them in an appropriate manner rather than to replace them. Thus, rail maintenance is an inevitable must.

### Increased knowledge implementable results and related cost reductions

Based on experiences obtained in track around the world, a maintenance programme to address RCF has been elaborated. It is based on the application of specific target profiles for grinding (AHC profiles) and on cyclic metal removal to

alleviate small surface defects and maintain optimal wheel-rail contact conditions. Main emphasis is put on the fact that only maintenance work planned in a strategic way and with optimised logistics will provide considerable economic benefits. Respective detailed information is provided in references [2, 3].

Some more general information on how to control RCF effectively and how to change from an existing corrective grinding policy towards a preventative one is given in [4].

### Open questions

As the appearance and development of RCF depends on many local parameters (traffic condition, track situation, steel quality, availability of grinding equipment etc.) further studies are required in order to select the relevant target profile (amount of undercutting of the gauge corner) and to fine-tune the global strategy (metal removal and related grinding cycle). This will provide information to further prolong the service life of rail and reduce life cycle costs.

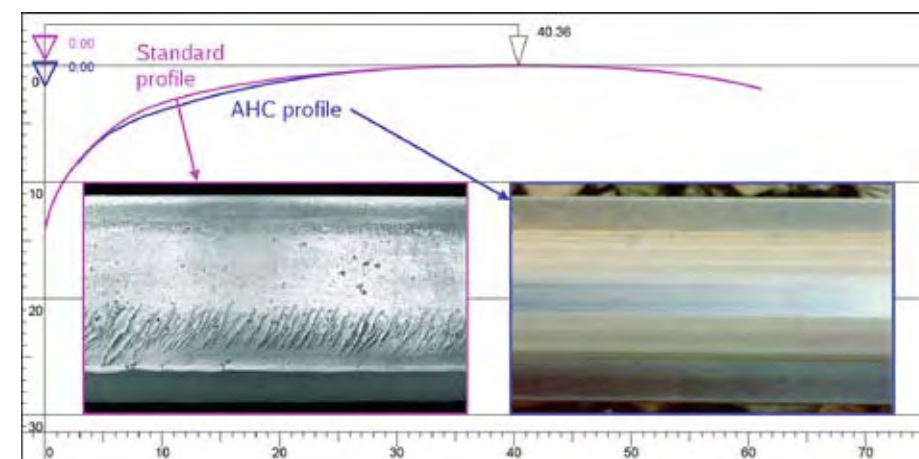

Figure 5.5.2-1: Standard profile with head checks (left) and cyclically maintained AHC profile (right)

## References

1. INNOTRACK Deliverable D4.5.1, Overview of existing rail grinding strategies and new and optimised approaches for Europe, 8 pp (and 3 annexes, spreadsheet + 23 + 7 pp), 2007
2. INNOTRACK Deliverable D4.5.2, Target profiles, 10 pp, 2008
3. INNOTRACK Deliverable D4.5.3, Fields of improvement in grinding practices as input for LCC evaluations, 16 pp (and 2 annexes, 11+7 pp), 2009
4. INNOTRACK Deliverable D4.5.5, Guidelines for management of rail grinding, 20 pp, 2010

## 5.5.3 Friction management

Wolfgang Schöch, Speno and Rolf Dollevoet, ProRail  
More information is available in deliverable D4.5.4.

### Background

Besides selection of the steel grade and grinding strategies, management of the friction between the wheel and rail also has a strong influence on wear and the development of RCF cracks. This can be achieved through gauge face (and wheel flange) lubrication and/or top of rail friction modification.

### Increased knowledge implementable results and related cost reductions

Gauge face lubrication is commonly used throughout Europe to control lateral rail and wheel flange wear. On the contrary, top of rail friction modification is still in an early introductory phase (at least in Europe) focused mainly on noise and corrugation mitigation.

Limited experience from laboratory tests and localised field trials demonstrated that there is a positive effect in term of

reducing RCF, wear, lateral forces, energy consumption and related costs. This points to the need for further widespread investigations that could not be done within the remaining limited time of the project. More details are given in Deliverable D4.5.4 [1].

### Open questions

Full-scale track tests under different specified traffic conditions are required to allow better understanding the effect of friction modification on LCC. Furthermore the method of application (onboard, track-side) and the controlling parameters need to be investigated to enable an optimised system to be designed taking into account environmental aspects.

### References

1. INNOTRACK Deliverable D4.5.4, Friction management methods, 13 pp, 2009

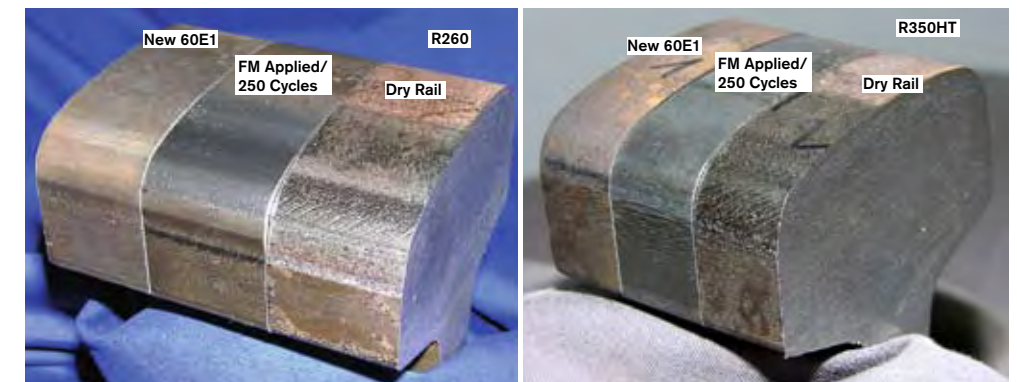

Figure 5.5.3-1: Comparison of rail grades (R260, R350HT) with and without friction modifier (FM) application, laboratory tests done at a full-scale test rig

## 5.6 Rail welding

Robert Gehrman, Elektro-Thermit and Jay Jaiswal, Corus

Welding of rails is mainly achieved by using two different methods, aluminothermic welding and flash butt welding. Both processes are well established and have gained a high level of process reliability. Aluminothermic welding is a mobile welding procedure predominantly used for repair and maintenance of tracks and welding of switches and crossings. Traditionally, flash butt welds have been manufactured in depot welding machines but mobile welding units are also available to undertake joining of rails in track. Flash butt welding is mainly used for the installation of new tracks and the renewal of tracks. Thus, the above two welding processes satisfy nearly the complete demand for welding of rails for the European networks.

A third process available as a competitor to both mobile flash butt and aluminothermic processes is Gas Pressure Welding (GPW). This process has not gained acceptance in European markets but is successfully deployed in other countries, for example Japan.

Any cost reduction initiatives in rail welding must not be considered in isolation since the weld is an integral part of the track system whose degradation (wear, plastic deformation, and RCF) is influenced by track maintenance operations such as tamping and grinding. Thus, it is not feasible or pragmatic to assign a benchmark life time for a weld and assess the additional benefits brought about by introduction of process improvements. Only track tests and detailed monitoring of the welds can show if weld properties improve during the time of the trial. However, knowledge of the key degradation mechanisms coupled with laboratory assessments of key properties provides a logical and scientific basis for introducing process improvements.

Furthermore, it is essential to demonstrate the need and benefits of new welding processes both in the laboratory and, more importantly, through in-service track trials. It is also useful to establish the area of application and if the improved properties are required for the given track conditions. For example, efforts to increase fatigue properties of welds are not required as long as fatigue is not an operational failure mechanism. However, if a higher resistance against fatigue can be obtained through improved control of the welding process itself, the benefits become worth incorporating within the standard process. However, if additional time, effort and resources are required during installation of the weld in track, the cost benefit analysis is likely to become adverse and make such improvements unnecessary and unjustifiable.

However, if new welding technologies are developed and if cost savings are the major driver for the improvement, the following aspects need to be taken into account:

- No additional costs for the new welding process compared to the standard process; which means:
  - execution of the weld in a minimum of time without compromising accuracy and quality
  - avoiding additional process steps during welding or any additional post weld treatments
  - no usage of additional equipment
  - avoiding the use of processes that make additional manpower necessary
- If additional costs of the welding process are accepted, the additional expenses need to be compared with the resulting benefit. This means that it needs to be evaluated

- if the lifetime of the weld can be verifiably increased
- if the failure rate and maintenance requirements can be verifiably decreased

- The applied welding technology should be as flexible as possible with regard to rail profiles, rail grades and rail condition (new or used rails)
- The applied welding technique should result in a weld with optimized properties with respect to
  - wear
  - resistance against rolling contact fatigue (RCF)
  - minimum width of the heat affected zone (HAZ)
- The process should be as mobile and as easy to handle as possible
- A further requirement for the development or improvement of current welding processes is their ability to weld premium grade steels in which property improvements have been achieved through alloying additions and/or heat treatment. The hardness profile through the heat affected zones of welds made between such rail steels and with the standard rail grades also needs to be optimised to reduce variability in wear performance.

However, there are three preconditions that must be fulfilled if the above improvements are to be realised:

1. A good quality track with appropriate support
2. Sufficient time for the execution of a good quality weld in track
3. A comprehensive training and testing programme to ensure the competence and skills of the welders.

Although the absence of virtually any failures of FB welds in service is a vindication of the integrity of such welds, there is circumstantial evidence of differential wear and “dipping” of some welds. Thus,

a desirable improvement for factory and mobile flash butt welding processes is a more quantitative approach to process control. FB welding machines are equipped with data logging equipment that monitor the key aspects of the process. Although audible alarms to indicate deviation from preset values of key parameters are available on some units, the analysis of the logged data is often restricted to visual assessment of the welding current and displacement charts. Furthermore, reliance of weld quality is placed largely on destructive testing of occasional welds to establish their bend strength. Such tests do not provide a proactive control of the process. Hence, a recommended development is the determination of the total heat input and the total displacement from the welding charts and using the information to establish a process “signature tune” for the particular welding unit. Process monitoring is then the detection of any significant deviation from this “signature tune”. This approach will provide greater reliance on the quality of the weld delivered to track and enable a correlation with their in-service performance to be established.

## 5.6.1 Aluminothermic welding

Robert Gehrman, Elektro-Thermit

More information can be found in deliverables D4.6.1, D4.6.2 and D4.6.6.

The key technical and economic aspects and emerging new technologies associated with aluminothermic welds are discussed in the following sections.

### Lifetime of an aluminothermic weld

Up to now no clear evidence is given regarding how long an aluminothermic (AT) weld can actually last within the track. The experience has shown that usually the weld lasts as long as the rail. Naturally, the traffic conditions, the condition of the superstructure and the maintenance of the track play influential roles in the life of AT welds.

Naturally, breaks of welds can occur. Weld breaks appear mostly a short time after the weld execution, typically after the first year. There is a high probability that execution errors are the root cause for these weld breaks. Only if the weld is subjected to very high axle loads wear

and fatigue cracking can become an issue and decrease the lifetime of the weld compared to the rail steel.

### Width of the heat affected zone (HAZ) of an aluminothermic weld

One of the fundamental aspects that needs to be considered with respect to in-service performance of AT welds is the characteristics of the HAZ. During welding the rail steel adjacent to the weld metal is subjected to very high temperatures resulting in a well-known drop of hardness in the HAZ (see Figure 5.6.1-1). The minimum hardness reached in the HAZ is basically determined by the chemical composition of the rail steel.

The width of the HAZ of aluminothermic welds can only be influenced to a small extent. Here the duration of the pre-heating mainly determines the influence of the welding process on the width of the HAZ.

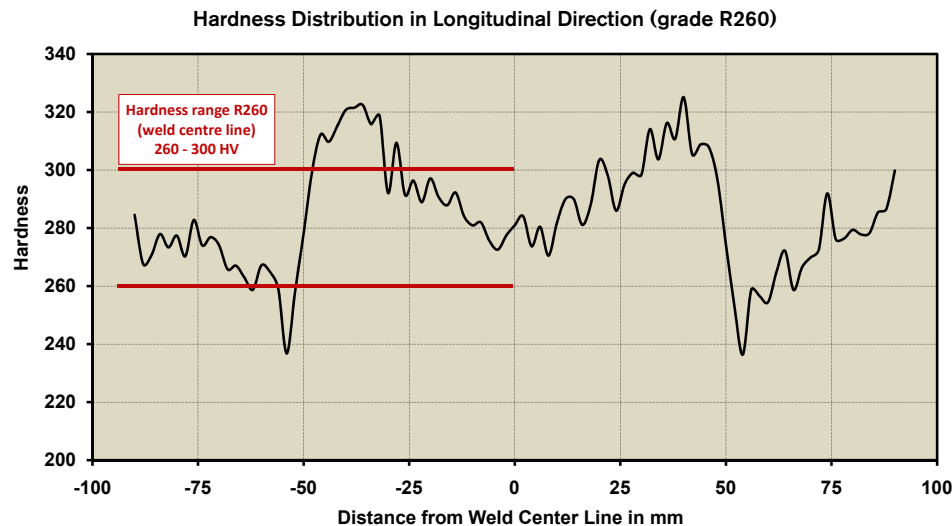

Figure 5.6.1-1: Typical hardness profile of an aluminothermic weld (rail grade R260)

For standard aluminothermic welding processes the width ranges between about 13 mm (profile 60E1; short pre-heating during 2 minutes) and about 20 mm (standard pre-heating time of approximately 5 minutes). These values differ for the different welding procedures and for the different rail profiles. However, the observed range of the width of the HAZ for the different welding processes is already very small. A further decrease in the width of the HAZ seems not to be possible. Reducing the heat input during pre-heating to a larger extent leads to the risk of an insufficient bonding between rail and weld or an insufficient resolving of rail steel respectively. Here the robustness of the welding process and the demand for a secure fusion under different construction site situations and weather conditions are more important than an absolute minimization of the HAZ.

Nevertheless, up to now no study has been undertaken systematically evaluate the influence of the HAZ width (and rail profile and rail grade) on the track/rail/weld performance (wear, RCF and failure mechanisms). The interaction between rail

(and weld) and wheel are more dependent on axle load, speed of the wheel and the friction between rail and wheel. Thus a large matrix of possible test conditions can be created. A detailed evaluation of the performance of the HAZ in comparison to the unaffected rail steel or weld metal should be the scope of future investigations, especially with new rail grades aiming for higher hardness and thus making the HAZ eventually more critical for the failure mechanisms mentioned.

### Post weld treatments

It is generally possible to achieve improved properties in an aluminothermic weld and the adjacent HAZ by additional treatment of the weld after the welding process.

Two methods have been introduced within the INNOTRACK project (see [2]): a mechanical post weld treatment (UIT method – Ultrasonic Impact Treatment) and a thermal treatment executed after the welding process. The first method focussed on a mechanical treatment of the weld collar of the finished weld in order to improve the fatigue properties (see Figure 5.6.1-2). The second method was applied to change

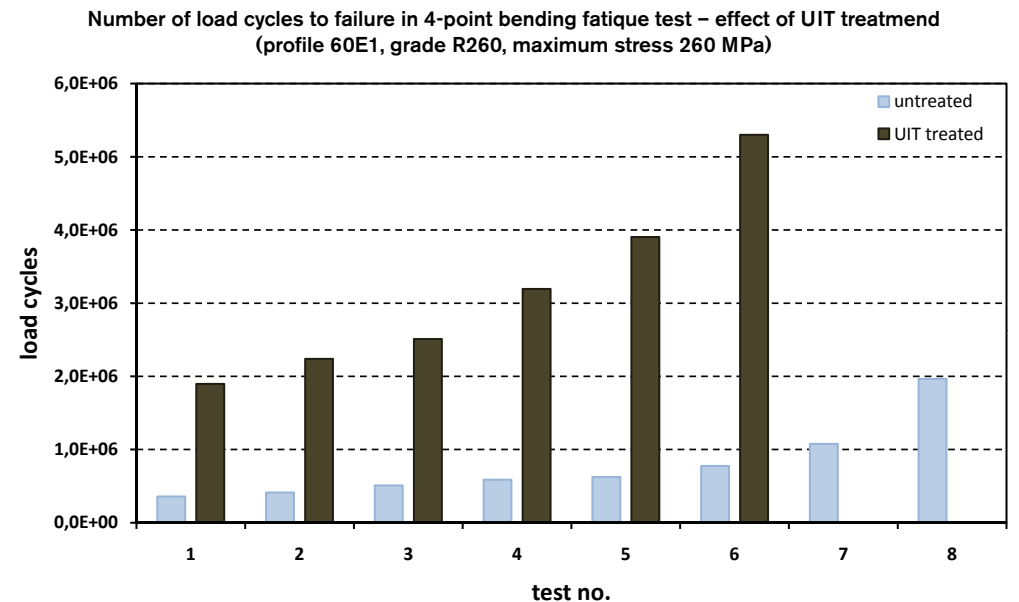

Figure 5.6.1-2: Results of fatigue tests of aluminothermic welds (rail grade R260).

the microstructure and to soften the base and web of the finished weld in order to increase the properties (deflection) during the static bend test.

Beside the thermal treatment mentioned above, another heat treatment can be executed in order to modify the weld properties. This so-called HC-treatment causes the formation of a very fine pearlitic microstructure and an increase of hardness. This second heat treatment covers the HAZ that has been created by the initial welding process. A new, small HAZ will be formed at the borders from the area that is affected by the post heat treatment. This process requires additional pre-heating equipment and it needs to be executed on the finished rail after fine grinding.

There are also other methods available – mechanical as well as thermal treatments that can be applied to the weld. However, none of these processes have gained acceptance as standard processes to be used in track. The additional costs and the additional time required to execute the post weld treatment are the most relevant reasons why these methods are not used.

For certain track conditions, e.g. heavy haul lines, special post treatments might be beneficial (UIT-treatment) if fatigue life is the limiting factor. This is not the case for European mixed or high-speed traffic. However, these methods need to be homologated and find acceptance by the railway authorities before operational usage.

#### High performance weld (HPW)

An innovation in aluminothermic welding is the HPW process (see [1]). Here, a selective alloying system results in that (for head hardened rails) the head of the

weld gets a high hardness whereas the web and the foot remain soft. This is a hardness distribution comparable to that of the bulk material of the head hardened rail. This welding principle leads to improved fatigue properties of the weld due to a higher ductility in the rail foot, and higher fracture toughness in the railhead.

The HPW method can also be used for welding standard rail grades (none-head hardened). The HPW process reduces logistical effort (and thus lower costs) regarding the handling and provision of consumables. However, the promotion of HPW process is currently focused on heavy haul tracks but, as yet, its use has been very limited.

Within the INNOTRACK project the HPW welding process and its applicability in track will be studied in detail during a track test [3]. One track test started in December 2009 in Germany and will be monitored in detail for two years

#### References

1. INNOTRACK Deliverable D4.6.1, The influence of the working procedures on the formation and shape of the HAZ of flash butt and aluminothermic welds in rails, 19 pp, 2008
2. INNOTRACK Deliverable D4.6.2, Report on the influence of the working procedures and post treatment on static and dynamic fatigue behaviour of aluminothermic welds, 13 pp, 2008
3. INNOTRACK Deliverable D4.6.6, Weld performance in track test – supervision of weld properties in terms of rail profile, rail straightness and neutral temperature (preliminary report), 42 pp, 2009

## 5.6.2 Flash butt welding

Vijay Jerath and Jay Jaiswal, Corus

More information can be found in deliverables D4.6.1 and D4.6.6.

The fatigue strength of factory flash butt welds is very similar to that of plain rail and the solid phase welding process imparts high internal integrity. The resulting robust quality of this welding process is reflected in the almost complete absence of any failures in track. However, the two key modes of degradation associated with flash butt welds are:

- Weld “cupping” – differential wear across the Heat Affected Zone (HAZ).
- Weld “dipping” – loss of longitudinal alignment over a short distance but extending beyond the weld.

The INNOTRACK project has responded to the challenge through the development of a narrow HAZ flash butt welding process that is covered by a Corus patent.

#### Development of narrow HAZ flash butt welds

A two-fold approach was adopted to achieve the desired aim of producing a factory flash butt weld with an HAZ width significantly narrower than those of standard production welds.

- As low a heat input as possible to achieve adequate weld consolidation.
- As low a conduction of heat away from the weld interface into the body of the rail as possible.

The achievement of the above objectives required close examination of the standard welding parameters and lead to the following key changes to arrive at a narrow HAZ weld:

- A slightly longer initial flash duration giving a longer localised heating cycle.
- A considerably lower number of preheats aimed at reducing the total heat input.

- Significant reduction in the durations of the preheat “on” and “off” periods aimed at reducing both the overall heat input and the total time for the heat to be conducted away from the weld interface.
- A shorter final flash duration giving a shorter localised heating cycle and reducing both the heat input and the heat conduction time.
- Lower forging (upset) distances – this is a direct consequence of the significantly reduced heat input levels.

#### Weld properties

1. The bend test loads of the welds produced by the new process were similar to those observed in welds made using the standards process but with greater deflections.
2. The width of the Heat Affected Zone (HAZ) has been significantly reduced as shown in the Figure 5.6.2-1.
3. As shown in the Figure 5.6.2-2 the hardness profile across the HAZ is more consistent and imparts wear resistance similar to the parent rails.
4. Fatigue strength of the narrow HAZ welds is slightly better than that of standard flash butt weld, see Figure 5.6.2-3.

#### Key advantages of narrow HAZ flash butt welds

- The process results in a narrower heat affected zone with a consistent hardness profile that provides uniformity of wear resistance to prevent “cupping”.
- The principles of controlled heat input employed in the process make it more suitable for the welding of premium grade steels produced either by micro alloying and/or heat treatment without the need for post weld controlled cooling.

- The shorter weld cycle times lead to greater productivity at the welding plant.
- The control of heat input results in an appreciable energy saving for the welding plant together with reduced wear and tear of the equipment.

### Open questions

There is little in-service degradation data with particular reference to “cupping” and “dipping” of flash butt welds. It is therefore recommended that a comprehensive programme of monitoring of inservice performance of pedigree welds is undertaken. Particular emphasis should be placed on the susceptibility of the main types of welds to “cupping”, “dipping” and the occurrence of rolling contact fatigue defects associated with the weld.

Hardness variation across the HAZ is the only material property assessment included in the major flash butt welding specifications. It is recommended that the resistance to wear and rolling contact fatigue be undertaken for the material within the heat affected zone.

### References

1. INNTRACK Deliverable D4.6.1, The influence of the working procedures on the formation and shape of the HAZ of flash butt and aluminothermic welds in rails, 19 pp, 2008
2. INNTRACK Deliverable D4.6.6, Weld performance in track test – supervision of weld properties in terms of rail profile, rail straightness and neutral temperature (preliminary report), 42 pp, 2009

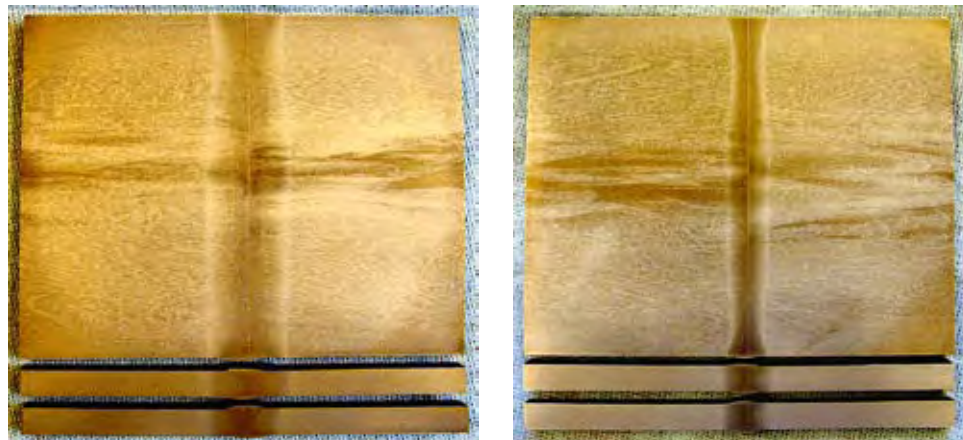

Figure 5.6.2-1: HAZ profiles for R350HT 60E1 rail

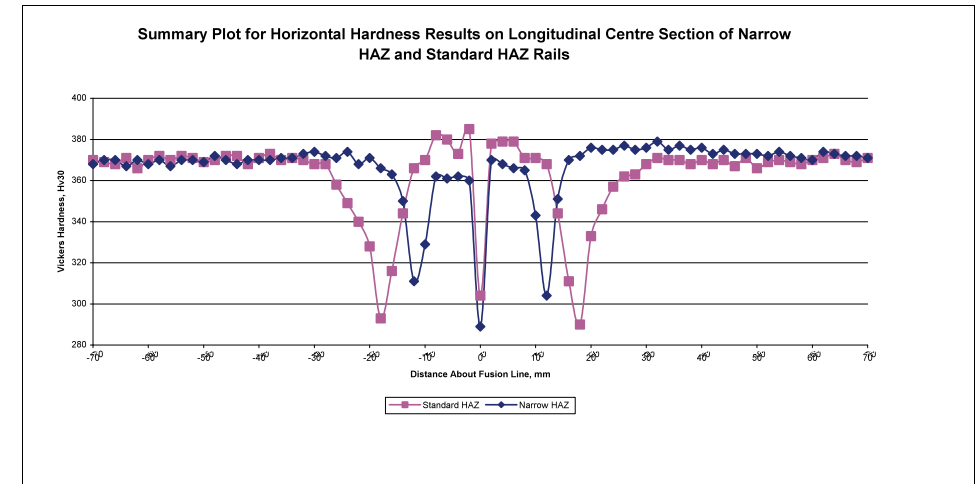

Figure 5.6.2-2: Hardness profiles of standard and narrow HAZ welds – R350HT 60E1

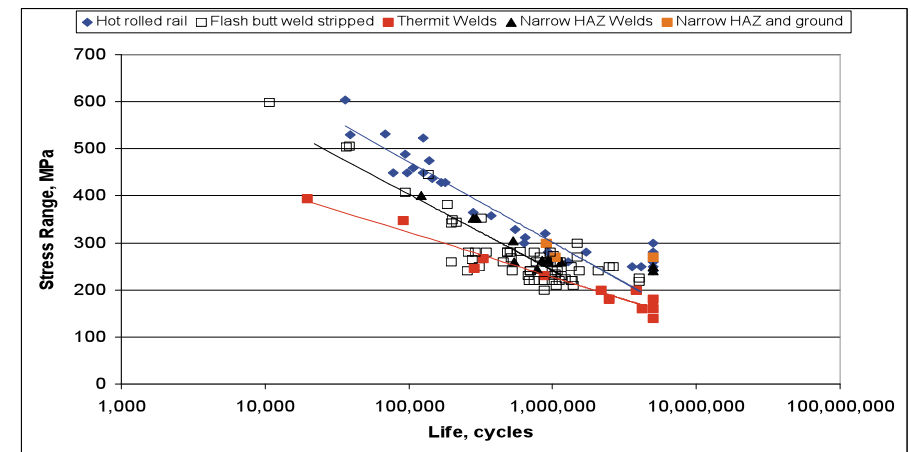

Figure 5.6.2-3: Fatigue lives at different stress ranges (S-N curves)

Position	HAZ Width (mm)	
	Standard Weld	Narrow HAZ Weld
Rail running surface	37	26
20 mm below rail running surface	35	21
86 mm below rail running surface	37	23
20 mm above rail foot base	38	20
rail foot base	38	23
rail foot tips	32, 36	24, 24

## 5.6.3 Gas pressure welding

Robert Gehrman, Elektro-Thermit

More information can be found in deliverables D4.6.4 and D4.6.5.

Gas pressure welding is a solid phase welding process that is used widely in Japan but has not yet gained acceptance in Europe. This welding process can be used in track in a manner similar to that of mobile flash butt welding. The basic difference between the two processes is the method of heating of the rails.

The work undertaken on gas pressure welding within the INNOTRACK project has focused on experimental set-up and the evaluation of properties of the welds produced employing this technique, [1]. A second report on the properties of gas pressure welds using a more suitable and advanced welding equipment has also been prepared, see reference [2].

It has been shown that gas pressure welds with good properties can be produced. The welding equipment and the welding process still need to be optimized in order to achieve a welding process that is comparable with (mobile) flash butt welding. The gas pressure welds presented in the INNOTRACK reports did not fully meet the requirements for flash butt welds, particularly with reference to HAZ width

and weld geometry. However, the results achieved indicate that gas pressure welding has the potential to become a reliable welding process. Although, gas pressure welds show a wider HAZ than flash butt and aluminothermic weld, the wear resistance of the HAZ region was found to be similar to that of parent R260 Grade rail. However, the applicability of this process for welding of harder heat treated grades has yet to be established particularly in view of the wider HAZ.

The welding process and the equipment needs to be optimized following which process approval to the requirements of a European standard (comparable to that of mobile flash butt welding, EN 14587-2) needs to be undertaken.

### References

1. INNOTRACK Deliverable D4.6.3/D4.6.4, Analysis of equipment design and optimisation of parameters for gas pressure welding, 32 pp (and 3 annexes 1+2+5 pp), 2008
2. INNOTRACK Deliverable D4.6.5, Gas pressure welding – Quality of test welds, 15 pp (and 3 annexes 8+23+10 pp), 2009

## 5.7 Main influencing variables on the logistics chain of rail supply.

Robert Baier, Albert Joerg, voetsalpine Schienen

The logistics chain of rail supply is one of the most important issues when logistics of rails is considered. In order to optimise the delivery of rails an exact understanding of the logistics path of a rail from the rolling mill to the installation site is strongly required. As there exist several delivery alternatives and associated needs, these different possibilities have to be considered in a detailed evaluation regarding economic impacts.

### Rail length

The length of the rail represents a key parameter concerning the logistics of rails. It defines the number of required weldings in track: the longer the rail produced in the rail mill, the less the required welds in field, or in a welding plant. This leads to a corresponding decrease in total welding cost and logistics expenditure not only during the installation process of rails in track. The utilisation of long or ultra-long rails provides significant LCC-reductions also during the operation period, since the majority of rail deficiencies and about 50 percent of rail breaks occur in weldings. These obvious benefits created by the use of long rails in track have determined several rail manufacturers to convert their rolling mills to enable the production of long rails. This is however related to huge investments in both production and finishing lines as well as to major logistical process adjustments.

### Rail welding

Generally two different methods for rail welding are currently available (aluminothermic welding and flash-butt-welding). These are executed in track and also in special welding plants (flash-butt-welding).

In order to produce continuously-welded-rail tracks, weldings can be accomplished on the one hand in tracks only and on the other hand as a combination of welding in plants and in-track welding. In the second case welded rail strings with lengths up to 400 meters or more are produced in welding plants and must then be transported by special long rail units (LRU) to the site, where the remaining welding is performed. In this context also the capital cost of the welding plant and of the LRU's must be considered.

### Transportation

Concerning railway transportation of rails two types can be distinguished: “interrupted transport” and “direct transport” (see Figure 5.7-1). Taking into consideration logistic processes and logistics related costs “direct transport” should be favoured whenever possible.

Additionally a just-in-time transportation of rails to the construction site allows a further minimization of manipulation actions as well as stock keeping and provides extraordinary advantages regarding logistics costs.

Depending on the lengths of rails different kinds of railway transportation modes

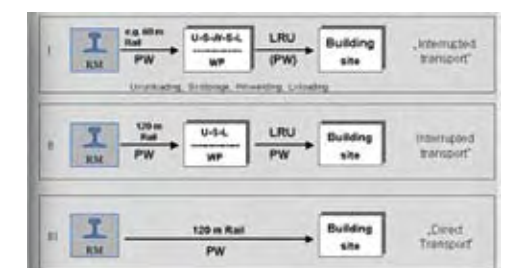

Figure 5.7-1: Transportation modes (RM: Rolling Mill, PW: Public Wagon, WP: Welding plant, LRU: Long Rail Unit)

are used: For shorter rails transportation can feature standard flatbed cars (pw in Figure 5.7-1) whereas special custom built long-rail-units, but also several connected standard flat cars (pw's that are generally available) are coming into operation for the transportation of long rails.

#### **Manipulation**

Rail manipulation is a part of the supply chain that can be eliminated for direct rail installation in track, but is unavoidable when rail delivery follows the interrupted transportation mode and also for repair workshops. The manipulation requires human resources for the operation of the machines, associated maintenance activities, and all other actions connected to railway shops.

#### **Stock keeping**

Stock keeping requires plants and associated areas with appropriate railroad connections and available human resources. It ties capital, which leads to additional costs without increasing the value of the rails.

The variables influencing the logistic chain of rail supply listed above are all reflected in the total logistics costs of rail supply. Depending on the mode of delivery these cost may differ considerably. In any circumstance they must be considered in addition to the pure material costs. Such an analysis will reveal benefits from new approaches towards logistics of rails (use of long rails, direct just-in-time transportation etc). This will yield significant contributions to the minimization of logistic related costs and consequently a general LCC reduction. To facilitate such analyses, deliverable D5.5.2 [1] includes calculation templates.

#### **References**

1. Innotrack Deliverable D5.5.2, Final report on the logistics of rails, 18 pp (and 1 appendix 8 pp), 2009

# SWITCHES & CROSSING 6



# SWITCHES & CROSSINGS

## 6.1 Optimisation of switches and crossings

The work in INNOTRACK on optimisation of switches and crossings can be summarized as follows:

### a. Identification of the major cost factors



### b. Optimisation via simulation:

- frogs (geometry and stiffness) and
- switch rails (horizontal and vertical stiffness, geometry)



### c. Optimised results (to be) realised as demonstrators



### d. Validating the benefit via LCC

### e. Parallel measures:

- Benchmark of frog materials on a test rig
- Stiffness measurements with RSMV car at DB

### 6.1.1 Identifying the major cost factors of switches

Gunnar Baumann and Wolfgang Grönlund, DB

More information on the identification of the major cost factors of switches with data input from DB and BV is available in deliverable D3.1.1.

#### Background

For optimizing the track related performance of s&c their key parameters have to be identified. The optimisation of s&c to reduce their LCC further requires the key parameters and constraints to be defined and the associated cost factors established. This leads to the following procedure:

1. In the first step the track related components of s&c are to be identified followed by the compilation of the general cost factors which result from maintenance activities. This gives an unvalued overview over all possible factors.
2. In the second step real cost factors based on the analysis of maintenance costs are to be identified.
3. Putting the results of steps one and two together gives a valued overview over the parameters that have the greatest impact on costs and are therefore of greatest importance in the track related optimisation of s&c. These are consequently the key parameters for track related optimisation of s&c.

(This approach explains the merging of the planned deliverables D3.1.1 and D3.1.2 in a single document.)

Data for analysis of cost factors have only been available from DB and BV. Due to insufficient infrastructure databases for getting data of costs for maintenance activities representative lines have, as far as possible, been selected for the cost factor analysis.

#### Increased knowledge, implementable results and related cost reductions

An analysis of the selected high-speed line of Deutsche Bahn (DB) featuring UIC 60

s&c, mixed traffic with about 17.5 MGT/year (average) and 458 chosen s&c identified the following key parameters:

- a. 50% of overall costs are for inspection, service and test measures. These are thus the main cost drivers overall at the selected DB line.
- b. Excluding inspection/service/test the main cost drivers (65% in total) are renewal of a half set of a switch (35%), large elements<sup>1</sup> (17%) and frog renewal (13%).  
Other activities like welding, corrective maintenance (e.g. minimal repair), tamping, etc., sum up to “only” 35% on the selected line.
- c. The first results from another DB analysis confirm these conclusions in general but show that the costs for renewal of switch rails are roughly equal to the costs for renewal of frogs.

The analysis of the maintenance costs of the selected line of Banverket (BV) with mixed traffic (about 25% passenger and 75% freight traffic) and an assumed 18 MGT/year, has identified the following key parameters:

The main cost drivers, excluding inspection/service/test, are

- Short-range planned actions after inspections with 30% (mainly including adjustment, build up welding and minimal repairs as actions after inspection)
- Long-range planned actions after inspection with 26% (including replacement of frogs, switch rails and check rails as part of the condition based maintenance)
- Costs for inspections & predetermined maintenance with 17%.

<sup>1</sup> The data bases do not include detailed specifications of the category 'large elements', but this category includes large components like frogs, switch rails, check rails etc.

The costs for these measures sum up to 73% with the amount for other activities (failure, grinding and tamping) being 27%.

### Open questions

Since the breakdown of maintenance costs by the detailed activities of short- and long-range planned actions and failures is not yet available, further analysis is required to break down the costs types of s&c and their

components, and associated maintenance activities. The differences between such costs for DB and BV should also be investigated.

### References

1. INNTRACK Deliverable D3.1.1/D3.1.2, Definition of key parameters and Report on cost drivers for goal-directed innovation, 37 pp, 2008

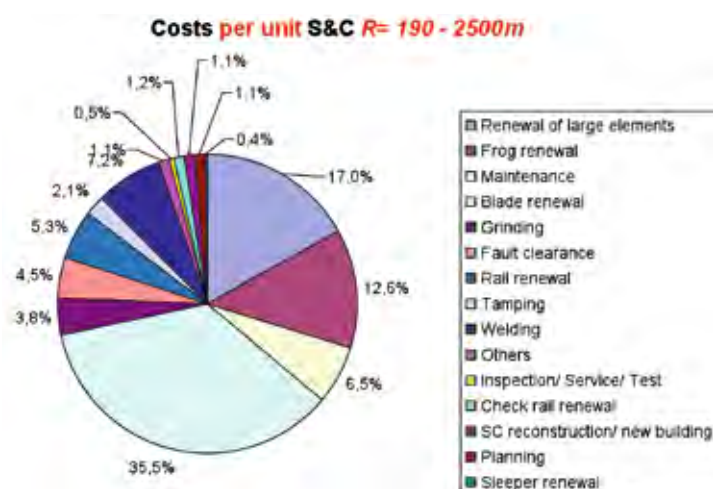

Figure 6.1.1-1: Cost driving maintenance activities for S&C on a selected line (DB)

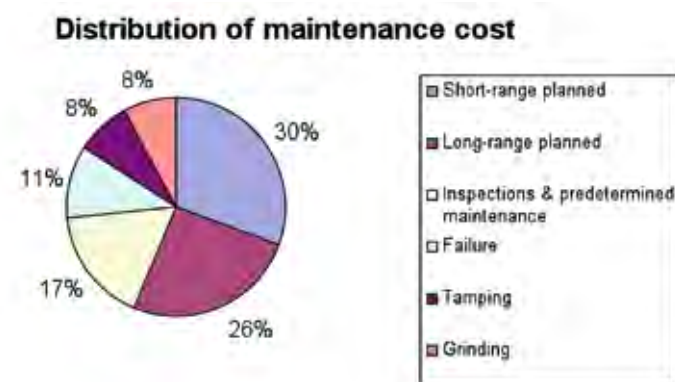

Figure 6.1.1-2: Distributed cost for maintenance of S&C on line 119 (BV)

## 6.1.2 Optimisation of switches and crossings

Jens Nielsen and Magnus Ekh, Chalmers. Elias Kassa, and Simon Iwnicki, Manchester Metropolitan University. Dirk Nicklisch and Wolfgang Grönlund, DB

More information on the benchmarking of models for simulation of dynamic interaction between vehicle and switch, and the subsequent optimisation work, is available in deliverables D3.1.4, D3.1.5 and D3.1.6.

### 6.1.2.1 Switch panel – stiffness and geometry

#### Background

It has been observed that railway vehicles often experience significant lateral displacements, sometimes leading to wheel flange contact, when running on the through route in the switch panel of railway switches. This often creates increased wheel and rail wear and on some occasions rolling contact fatigue (RCF) problems on the rails, requiring increased supervision and maintenance and reducing the life of the components.

The transfer of the wheel–rail contact load between the curved stock rail and the switch rail takes place a few metres after the wheelset enters the curved path. An artificial increase of the track gauge takes place on this side of the switch, and therefore a rolling radius difference is generated between the two wheels, which induces a lateral movement of the wheelset towards the switch rail. When the load is finally transferred to the straight switch rail a sudden reduction of the gauge takes place, which again causes the wheelset to be out of the central position. To minimise the effect of this phenomenon on the performance of the switch, a number of possible solutions have been proposed, as for example the MaKüDe system developed by DB Systemtechnik. One of the solutions is applying a dynamic (prescribed) variation of the track gauge by modifying the straight stock rail.

Further, the continuous variation in rail cross-section along the switch panel

leads to a continuous change in track stiffness, which has been confirmed by track receptance measurements at several locations in an s&c at Härad in Sweden. These measurements show that the rail (and rail pad) stiffness at 9.1 m from the front of the switch is 40% higher than the corresponding stiffness measurement at 4.5 m, and that the stiffness was further increased to 70% higher at 21.85 m.

#### Optimisation of geometry

The work of INNTRACK aimed at answering the following questions:

- what is the optimal way of designing the dynamic gauge widening so that wheel–rail forces and track damage can be minimised?
- what benefits can be expected in terms of reduced track damage?

In this study, the dynamic gauge variation was defined by three parameters (see Figure 6.1.2-1):

- The diverging stock rail is curved with a given radius  $R_C$  (corresponding to the diverging route). Initially, the same radius  $R_C$  is used for the straight stock rail.
- The second variable  $R_{Out}$  represents the curvature of the straight stock rail after the wheel–rail contact is transferred from curved stock rail to switch rail (at  $L_{Jump}$ ).
- The third variable  $L_{Total}$  defines the total length of the dynamic gauge variation from the start of the switch.

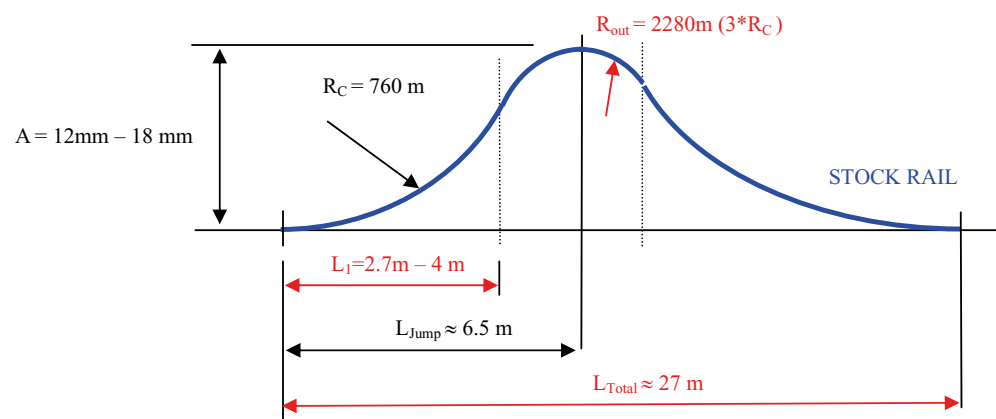

Figure 6.1.2-1: Parametric representation of optimal gauge variation on the straight stock rail

The optimisation study was carried out using a freight vehicle with  $\gamma 25$  bogies in the laden condition. This is expected to be more damaging to the track than passenger vehicle operations. For the nominal switch design, vehicle dynamics simulations were performed with 18 different measured wheel profiles. The results in terms of normal and tangential wheel-rail contact forces and contact point positions on the rail were then compared with those obtained for a modified switch design. After the optimal shape for the dynamic gauge was established, a validation study was carried out using two different vehicles and more wheel profiles: a laden  $\gamma 25$  freight vehicle with 18 different measured wheel profiles, and a typical EMU (modelled using the parameters defined in a parallel workpackage of INNOTRACK) with another set of 18 measured wheel profiles. The performance was assessed in terms of the wear index  $T\gamma$  and by the shakedown diagram (contact stress versus traction coefficient), which represents a measure for RCF. The optimal values chosen for the dynamic gauge increase are shown in Figure 6.1.2-1.

On the basis of the analysis, the following guidelines are proposed:

- The amplitude of the gauge increase (here represented by  $A$ ) is the most critical design criterion. The optimal value for  $A$  is not obvious as minimum tangential

forces are obtained for high amplitudes of the dynamic gauge. However, large values for  $A$  may lead to peaks in contact stresses and cause the wheelset trajectory to overrun to the opposite side. At distance  $L_1$ , a dynamic gauge widening of around 0.5 times the maximum gauge amplitude seems to give a good compromise.

- The other design parameters are less relevant to the behaviour. However, it would be recommended to have a smooth curvature in the transition from the maximum amplitude back to the normal gauge. A longer dynamic gauge increase seems to perform a little better but obviously care should be taken not to interfere with the crossing nose.

A significant reduction of the risk of RCF taking place is apparent with the optimised gauge. The traction coefficients are effectively reduced with optimised switch designs with a maximum gauge increase of 12 mm or 18 mm amplitude. There is also a reduction in the contact stresses but this is less significant. The main benefits obtained by the proposed new designs are:

- A significant reduction in wear, represented by  $T\gamma$ , at all locations analysed along the switch. Also, more consistency in the  $T\gamma$  results when using different wheel profiles.

- A significant reduction in traction coefficient at all times, and therefore improved behaviour in terms of RCF.
- Only very small or no reduction of contact stresses. In this respect, it would be advisable to carry out the dynamic gauge optimisation along with an optimisation of the shape of the rail profiles.

#### Optimisation of stiffness

Two track models with varying vertical track stiffness parameters along the switch panel have been developed and their receptances have been compared with measured values. Compared to the track model that was tuned based on the track receptance measurements, the values of the rail/rail pad stiffness ( $k_p$ ) and the sleeper/ballast stiffness ( $k_b$ ) were optimised as follows:

- The rail pad stiffness ( $k_p$ ) is arranged so that the stiffness increase between a location at 4.5 m and a location at 21.85 m is about 8 %. This can be achieved by placing stiffer rail pads starting from some distance before the front of the turnout and softer rail pads close to the switch heel.
- The ballast stiffness ( $k_b$ ) value is increased by 20 % at 4.5 m, reduced by 10 % at 9.1 m and reduced by 20 % at 21.85 m from the nominal values, corresponding to 39 MN/m, 41 MN/m and 47 MN/m, respectively.

The optimisation was performed for one load case. The vehicle model was simulated in the facing move of the through route and with different track stiffness arrangements which included the nominal and optimised variations. A large reduction in wear index is obtained when optimised  $k_p$  and  $k_b$  stiffness values are used in combination. The reduction is seen for both the stock rail and the switch rail contact points. At the stock rail contact point, the maximum wear index is reduced by 50 % from 18.9 N to 9.5 N. The maximum wear index at the switch rail contact is reduced by 80 %.

#### Open questions

The gauge optimisation presented here was based on the position of the contact point jump location for one type of load case. A more thorough analysis that includes other load cases and scatter in load conditions should be considered in the optimisation process. Other types of gauge widening geometry, with more design variables, could be investigated. A more detailed damage analysis could also provide a more accurate quantification of the achievable benefits in terms of extension of life of the components and reduction of the maintenance costs.

A more advanced track model, based on a finite element model (FEM) that can describe all the different flexible components and better represent the stiffness variation along the turnout is required to carry out a comprehensive track stiffness optimisation exercise. An optimisation of lateral track stiffness could also be performed, mainly for the diverging track. The simulation work in INNOTRACK was based on rails with no inclination. However, different countries adopt different rail inclinations in turnouts and the influence of rail inclination could be investigated to identify an optimum inclination.

## 6.1.2.2 Crossing panel – stiffness and geometry

### Background

One objective of the work in INNOTRACK was to optimise the transition geometry and the supporting elasticity of the superstructure in order to minimise the material degradation induced by wheels passing the frog (crossing nose and wing rails). For this purpose, the influence of different system parameters on the impact loads on a German standard crossing EH 60-500-1:12 has been studied. In addition, several alternative frog geometries have been investigated to find an optimal geometric design for the crossing nose and wing rails.

The simulations were carried out using a LOCO BR 101 and an ICE-T coach (BR 411) modelled in the commercial multibody dynamics software SIMPACK. Three different wear states of the wheel profiles were used: nominal S1002, medium-worn and hollow worn. The track was represented by a finite element model (FEM) consisting of elastic rails and elastically supported elastic sleepers. Because of the higher speed and consequently higher impact loads compared to the diverging route, only the through route of the turnout was considered.

The investigation was based on the assumption that the maximum normal wheel-rail contact force is representative for the material degradation on the crossing. To verify this approach, it was decided to use Kalker's CONTACT program for additional calculations of the maximum contact stresses for some selected load cases. The result of Kalker's linear-elastic material model is the three-dimensional stress state within the discretised contact patch from which the equivalent von Mises stress has been determined.

### Increased knowledge and implementable results

The results of the investigation regarding track stiffness showed that a reduction of

track stiffness from 500 kN/mm to 85 kN/mm by the use of elastic rail pads leads to significantly lower normal contact forces. Further, this effect increases with increasing speed. Also for the case with one unsupported sleeper below the transition area of the crossing, slightly reduced impact loads could be observed. Thus the modification of track stiffness in the crossing area shows a high potential for the reduction of material degradation of frogs. However, it has to be considered that the softening of the elastic foundation has to be limited to avoid fatigue of the rail foot caused by bending.

Regarding the optimisation of the transition geometry of non-movable crossings, two general approaches have been discussed. The first one has the target to prevent the wheel from making contact with the crossing nose at a section being too weak to withstand the impact loads. The second approach aims at smoothing the vertical wheel movement during the transition between wing rail and crossing nose to reduce the impact loads. Based on these approaches, the following designs were investigated by numerical simulations:

- Reduction of the flange-way width between crossing nose and wing rail in order to delay the transition area to a thicker cross-section of the crossing nose.
- Profiling of the frog by using a kinked ramp to decrease the gradient of the vertical wheel movement after transition to the crossing nose (optimisation for facing move).
- Superelevation of the wing rail and profiling with a negative wheel shape to reduce the vertical wheel movement (MaKüDe).

Examples of the improved vertical wheel movement compared to what is obtained for the nominal frog geometry are shown in Figure 6.1.2-2.

Initiated by the known problem of damaged wing rails due to hollow worn wheels

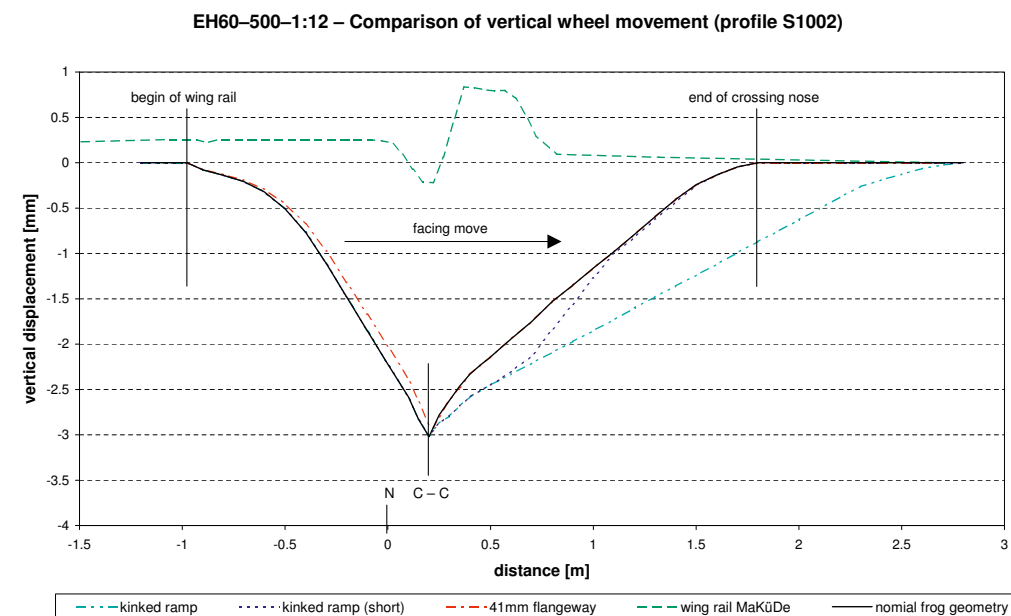

Figure 6.1.2-2: Comparison of vertical wheel movement for different transition designs (wheel profile S1002). Point N indicates the tip of the crossing nose (distance = 0 m), C-C is the theoretical point of wheel transition

passing in the trailing move, another modification of the design was further investigated. In the trailing move, the outer section of the hollow worn wheel arrives too deep and hits the gauge corner of the wing rail. To avoid this, a small chamfer was added on the rail flange to reduce the contact angle when the wheel is transferred to the wing rail.

The results from the numerical simulations illustrate that it is difficult, if not impossible, to find a solution which leads to a contact force reduction for all wheel profiles occurring in service. Nevertheless, the MaKüDe design developed by DB Systemtechnik showed the best performance especially for mean worn wheel profiles for both running directions (facing and trailing moves). In connection with reduced support stiffness, this crossing design will lead to a significant reduction of the impact loads and consequently provides a high potential for LCC reduction.

### Open questions

The investigation of contact stresses on crossings calculated by means of Kalker's CONTACT program has demonstrated the limited usefulness of linear-elastic material models in this field of application. On the other hand, considering only maximum contact forces with regard to material degradation on frogs could lead to wrong conclusions. Before carrying out expensive in-field tests, the most promising crossing designs could be investigated by means of the simulation methodology developed by Chalmers (see section 6.1.2.3) to compare crossing degradation due to plastic deformation and wear under the same operating conditions.

### 6.1.2.3 Crossing panel – material selection based on simulations and lab tests

#### Background

Important material requirements for a rail steel are to withstand rail profile degradation (due to wear and plastic flow) and fatigue cracking. The requirements on the rail material in a switch are in general higher than for normal rail track due to the high tractions and impact loads in the wheel–rail contact. To investigate the performance of different rail materials, laboratory tests and simulations have been carried out.

Laboratory tests for four different materials R260, B360, Mn13 and R350HT have been performed to determine their tensile strength and fatigue behaviour. The steels have also been investigated metallographically, including chemical analyses, hardness measurements and microstructural studies. Simulations have been performed in order to predict the actual performance of materials in switch components. The modelling of the material behaviour was based on the laboratory test results. The actual stress-strain conditions were obtained via dynamic simulations in multibody dynamics software and nonlinear finite element simulations.

#### Increased knowledge and implementable results

Based on the laboratory tests, an ordering of the materials from a tensile strength point of view gives in descending order B360 followed by R350HT and R260, see Figure 6.1.2-3 (left). Mn13 has the lowest tensile strength but the longest elongation to rupture. This indicates that the manganese steel can accumulate significant plastic deformations before fracture.

The constant strain amplitude fatigue tests show the difference in cyclic plastic deformation behaviour of the steels, see Figure 6.1.2-3 (right). The pearlitic R260 and R350HT soften somewhat initially, but harden slightly during the latter part of their life. The bainitic B360 softens continuously during the life, while the austenitic Mn13 shows distinct initial hardening followed by softening. From these tests, the bainitic B360 performed the best, followed by R350HT, R260 and Mn13. However, the test results for Mn13 material do not agree with the observed good experience in track. The reason is that the cyclic tests were conducted at alternating tensile and compressive stresses, while the loading in

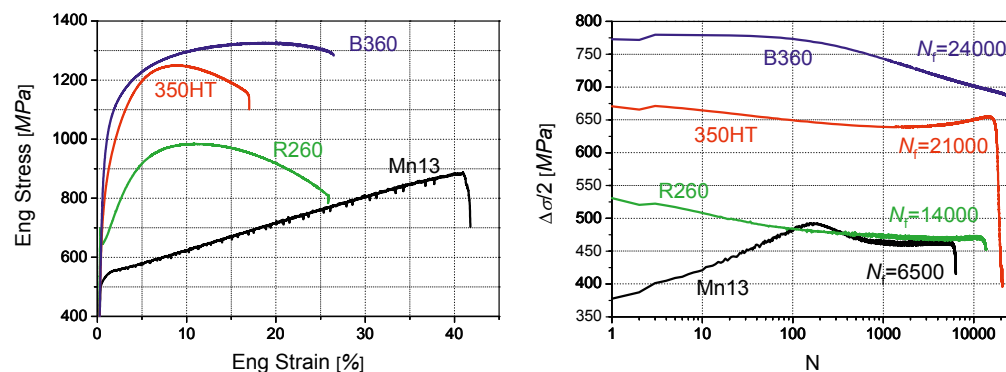

Figure 6.1.2-3: Tensile tests at room temperature with a strain rate of  $10^{-4} \text{ s}^{-1}$  (left). Fatigue tests with stress amplitude development at 0.4% strain amplitude (right)

track is mostly compressive which is more favourable for Mn13.

A methodology for predicting damage (material degradation) of s&c components via simulations has been developed. The methodology involves an integration of several numerical tools as described below. For a given s&c design (curve radius, crossing angle, steel grade, etc) with a nominal set of rail profiles, the methodology includes the following three main steps:

1. Vehicle dynamics simulations, taking into account a mixed traffic situation, to calculate wheel–rail contact forces, creepages and contact positions.
2. Wheel–rail contact simulations for each load cycle to determine non-Hertzian wheel–rail contact patches taking into account the elasto-plastic material behaviour.
3. Finite element simulations and wear simulations for a large number of load cycles to predict the plastic deformations and wear of the material.

The new set of updated (degraded) rail profiles are then used as input in further simulations of vehicle dynamics with the same sets of stochastic vehicle input data. A validation of the simulation procedure has been performed for a crossing nose made of R350HT and subjected to a mixed traffic situation at Haste in Germany.

Good agreement between simulated and measured profiles after five weeks of traffic was observed, see Figure 6.1.2-4.

#### Open questions

In order to investigate the compressive behaviour of Mn13, a new experimental procedure needs to be designed. Only experimental data for the steel grades R260 and R350HT were available sufficiently early in the project. These steel grades are not used for the same type of switch components and therefore simulations have not been performed to compare/optimize the steel grades. Instead the main result in this part of the project was the development of the simulation methodology itself, which in future work can be used to choose/optimize the steel grade.

#### References

1. INNOTRACK Deliverable D3.1.4, Summary of results from simulations and optimisation of switches, 38 pp (and 4 annexes, 16+13+25+21 pp), 2009
2. INNOTRACK Deliverable D3.1.5, Recommendation of, and scientific basis for, optimisation of switches & crossings – part 1, 30 pp (and 2 annexes, 12+12 pp), 2009
3. INNOTRACK Deliverable D3.1.6, Recommendation of, and scientific basis for, optimisation of switches & crossings – part 2, 20 pp (and 3 annexes 10+14+16 pp), 2009

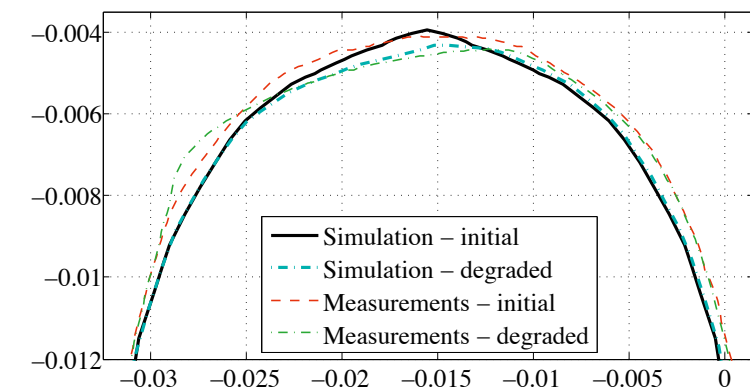

Figure 6.1.2-4: Measured and simulated crossing nose profiles at Haste before and after five weeks of traffic. Dimensions in metres

## 6.1.3 Optimised results used in demonstrators

Wolfgang Grönlund, DB

A draft specification of the S&C demonstrator is available in deliverable D3.1.3. The results of the demonstrator tests at DB and BV will be available in the deliverables D3.1.8 – 3.1.10.

### Background

The main cost factors that acted as the motivation for optimising frogs and switch-blades have been identified in an earlier section (6.1.1). The process of optimisation has been based on numerical simulations as this approach permits parametric evaluation of all key factors to arrive at the optimised configuration. The final validation of the optimised design parameters will be undertaken through in-service demonstrations and these are detailed in this section.

It should be pointed out that this approach is a first of its kind in which optimised track related components of a switch have been developed employing scientific assessments and simulation tools in a

European wide collaboration of suppliers, infrastructure managers and universities instead of the a time consuming approach of 'learning by trial and error.'

### Increased knowledge, implementable results and related cost reductions

The choice of demonstrator test sites is a compromise between waiting for the ideal s&c site with representative European duty conditions and the more pragmatic approach of choosing a site where the s&c is already planned for renewal within a short period. This is the reason for a slightly late start of some demonstrators.

The demonstrators are scheduled as follows:

FROG DEMONSTRATORS (CROSSING PANEL)			
Testsite	Location	Demonstrator	Starting
DB	Haste	1 frog with optimised geometry "kinked ramp"	in May 09
		1 frog with optimised geometry "MaKüDe"	in May 09
	Worms	6 frogs with optimised vertical stiffness	beginning of 2010
BV	Eslöv	2 x 2 frogs with optimised (lower) vertical stiffness	October. 2009

Table 6.1.3-1: Schedule of frog demonstrators

SWITCH RAIL DEMONSTRATORS (SWITCH PANEL)			
Testsite	Location	Demonstrator	Starting
DB	Frankfurt,	3 switches with test of horizontal stiffness	Easter 08
	Wirtheim		
BV	Eslöv	4 switches with test of vertical stiffness (incl. gauge widening in the switch panel)	October 2009

Table 6.1.3-2: Schedule of switch rail demonstrators



Figure 6.1.3-1: DB test site Haste (left) and BV demonstrator switch in Eslöv (right) Switch rail demonstrators (switch panel)

### Measuring on site

All demonstrators are evaluated by a number of measurements. So far the following measurements have been taken into account:

- Force measurement by instrumented wheel sets
- Force measurement by strain gauges on the rail
- Vibration/acceleration-measurements to study the deflection of the rail
- Stiffness measurement by vehicle
- Measurements of geometrical behaviour and changes
- Stiffness measurement by hammer impact

DB, BV, Vossloh and VAE are involved in the demonstrator activities. Collaboration between the participants to ensure the comparability of the (measurement) results has been assured.

### Open questions

The first results of the demonstrator tests outlined here are expected about a year after the start of the test. Past experiences has shown that validated results can normally be expected 1.5 years after the start of the test.

The results from the demonstrators will be incorporated in LCC evaluations to show the economical benefits of the innovative solutions.

### References

1. INNTRACK Deliverable D3.1.3, Draft specification of the s&c demonstrators, 19 pp, 2009
2. INNTRACK Deliverable D3.1.8, Results from field testing of frog materials in Haste, *to be delivered in December 2010*
3. INNTRACK Deliverable D3.1.9, Results from field testing of switch panel support stiffness in Frankfurt and Wirtheim, *to be delivered in January 2011*
4. INNTRACK Deliverable D3.1.10, Results from field testing of s&c support stiffness in Eslöv, *to be delivered in May 2011*

## 6.1.4 Parallel measures

In the work on switches & crossings in INNOTRACK, the need for additional measurements not initially planned was recognized. One such issue was the testing of different frog materials in a test rig to rank different frog materials and support test and validation data to numerical simulations.

Another issue was the track stiffness of switches & crossings, which was identified in the numerical simulations as a very im-

portant parameter. Through full-scale measurements, the track stiffnesses of several s&c's were established. In addition to the increased knowledge, this data is of high importance in improving the numerical simulations and ultimately in optimizing the s&c's further.

### 6.1.4.1 Benchmark of frog materials on a test rig

Andreas Zoll, DB

The results of the benchmark of frog materials will be available in deliverable D3.1.7.

#### Background

The initial problem in INNOTRACK has been that installations of “new materials” i.e. in frogs need approval of national railway authorities. This requires time consuming and complex investigations to get all data necessary for the homologation process. As an estimate this takes roughly one year. This approach did not fit well in the 3-year time limit of INNOTRACK. In addition, testing of materials at field sites is in itself costly and time consuming. It was therefore decided to carry out a comparison of frog materials in the Kirchmöser test rig, while the parallel demonstrator tests (as described in the previous section) focused on optimised geometry and stiffness.

#### Increased knowledge, implementable results and related cost reductions

The advantages of a benchmark on the test rig are:

1. Short test times.
2. The results are comparable (ranking)
3. The tests need no approvals from national authorities.

The benchmark tests on the test rig consist of:

- Long-term tests with frog test pieces for duty conditions (forces) which correspond to operations at speeds of 160 km/h. The duration is about 1.5 weeks per material (equal to 12 million gross tonnes)
- Additionally, for each material there is an investigation of:
  - Macro cross-sections
  - Micro cross-sections
  - Hardness distribution
  - Tensile strength

The tests cover the following materials:

- Bainit B360 (Vossloh)
- Mn not hardened (VAE)
- Mn explosion hardened (VAE)
- Mn variation (VAE)

The reference material is fine pearlite.

#### References

1. INNOTRACK Deliverable D3.1.7; Results from laboratory testing of frog materials in Kirchmöser, to be delivered in September 2010



Figure 6.1.4-1: Test rig for frog materials at DB in Kirchmöser (left) and test specimen (right)

## 6.1.4.2 Stiffness measurements with RSMV car at DB

Wolfgang Grönlund, DB and Eric Berggren, Banverket

More information about the stiffness measurements in switches is available in deliverable D3.1.11.

### Background

Until now the real stiffness of switches is largely unknown with only few measurements undertaken. The objectives for the INNOTRACK stiffness measurements were:

- Continuous measurement of vertical stiffness in the switch
- Optimisation of stiffness in the frog and switch rail area in order to decrease wear and increase operational life resulting in LCC reductions

In addition, measurements of stiffness of switches will be useful input data for future simulations.

### Increased knowledge, implementable results and related cost reductions

Continuous stiffness measurements with the RSMV car from Banverket have been carried out between April 15 and 17, 2009 on switches in Borkheide (near Berlin), on the high speed route Berlin–Hannover, and on switches in Haste and Minden.

These switches comprise:

- concrete sleepers
- timber sleepers
- slab track (high speed line)
- ballasted track
- transition slab track to ballast track
- elastic rail bearings
- normal rail bearings

The speed of the measurement train was about 5 km/h while passing the switch. The excitation frequency was 10 Hz.

Some example results are presented in Figures 6.1.4-2 and 6.1.4-3.

Figure 6.1.4-2 shows a stiffness of about 70 kN/mm in the switch rail panel and about 90 kN/mm in the other panels of the two switches W4910 and W4911. This low stiffness is due to the elastic support stiffness (pads) of 30 kN/mm. It is noticeable that the s&c units are softer than the surrounding track, where the stiffness is about 170 kN/mm. This is caused by the rigid support stiffness of 600 kN/mm used in the track.

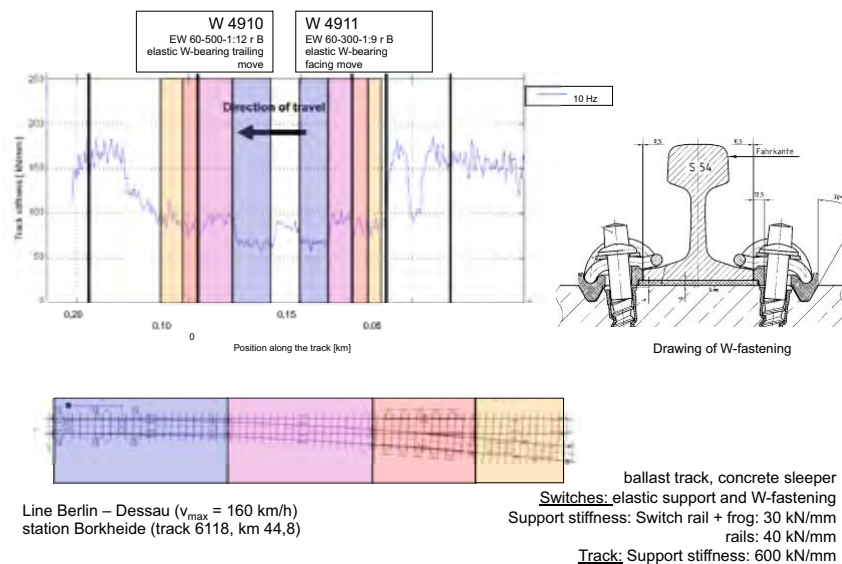

Figure 6.1.4-2: RSMV stiffness measurements at DB: normal switches UIC 60-500 / -300

Figure 6.1.4-3 shows a stiffness of about 50 to 70 kN/mm in the switch, while the surrounding slab track has a stiffness of about 120 kN/mm. This can be explained by the very elastic support stiffness employed both in switch and track. As seen from a comparison with Figure 6.1.4-2, the measured slab track stiffness is lower than for the ballasted track.

(with respect to operational life and LCC costs) for ballasted track, slab track and switches follow.

### References

1. INNOTRACK Deliverable D3.1.11, Results of continuous RSMV stiffness measurements on switches at DB, 16 pp (and 7 annexes 1+1+1+1+1+1+1 pp), 2009 [confidential]

### Open questions

Based on the results of these measurements, a discussion on optimised stiffness

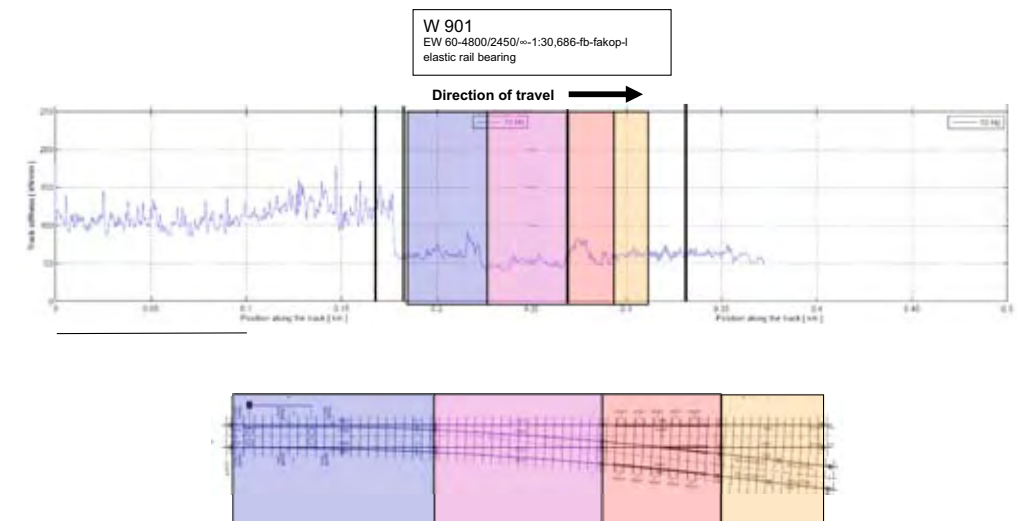

High speed line Berlin – Hannover ( $v_{max} = 250$  km/h)  
station Rathenow (track 6185-1, km 169,0)

slab track  
Switch: elastic rip-plate support (ERL) on slab track,  
support stiffness: ERL: 17,5 kN/mm  
Track: support stiffness: 22,5 kN/mm

Figure 6.1.4-3: RSMV stiffness measurements: normal switches UIC 60-4800/2450, slab track



## 6.2 Control and monitoring of switches and crossings

---

The work in INNOTRACK on control and monitoring of switches and crossings had several objectives. One was to start the work on an open standard interface for electronic interlocking. Some aims of this work was to harmonize the different interfaces that exist in Europe today, and to employ standard components to decrease LCC. Another strive towards standardization was the development of a hollow

sleeper. This work has now been passed on to the CEN. A third objective in INNOTRACK was to specify which requirements that can be prescribed for an actuation system. This also relates to switch monitoring systems that can be able to detect faults before they become critical. The work on these topics in INNOTRACK is described in this section.

### 6.2.1 Functional requirements for an open standard interface for electronic interlocking

Andreas Ziemann, ConTraffic

More information is available in deliverable D3.2.3.

---

#### Background

The interface between the interlocking system and the trackside equipment has developed historically with the components and the interlocking technology. Therefore very different interfaces exist in Europe today, depending on the installed components and the applied interlocking technology. There is no single standard. All solutions show a dedicated analogous connection for controlling and driving track components like signals, track vacancy detection and switch actuators.

For the control of switches, two principal designs can be differentiated. In the first design the power supply of the drive and the position detection of the switch are realized by separate wires, requiring at least a 6-wire cable. In the second design cable cores are used by change-over processes in the interlocking system for both power supply and position detection.

The latter is the case with the “4-Drahtschaltung”, which is common in German-speaking countries. This solution was developed in the 1930s in order to reduce the copper requirement of cabling a route, since this circuit operates with fewer wires than any other similar switching circuit.

An objective of INNOTRACK was to specify a European standard for a modern switch interface with clear benefit for the railway infrastructure companies, regarding functionality and life cycle costs, as compared to the status quo. For this reason, attention was given to creating the necessary room for innovative steps to break from current practice. The standardization effect promises additional scale effects with respect to cost reduction

within Europe. A change of the competition environment in the supply industry, which may be implied by the standardization, is not in the focus of the INNOTRACK project. However, INNOTRACK can support the process.

The INNOTRACK project is focussed on track sections with medium to high volumes of traffic, since these have the most economical relevance for the infrastructure operator.

#### Proposed open standard for electronic interlocking

During the INNOTRACK project an approach was developed to simplify installation and standardize the interfaces. The basic concept is the use of Industrial Ethernet as a communication standard.

The sensor and signalling components are separate from the power source (see Figure 6.2.1-1).

This concept enables:

- Easy installation of field elements such as switch machines into the interlocking system.
- Implementation of remote monitoring and diagnosis of the switch.
- Implementation of preventive maintenance concepts based on remote monitoring.
- LCC reduction due to reduced inspection costs, enhanced availability and reduced delays.
- Use of standardized and cost reduced components.

The implementation of an open standard is a must to achieve significant cost reduction.

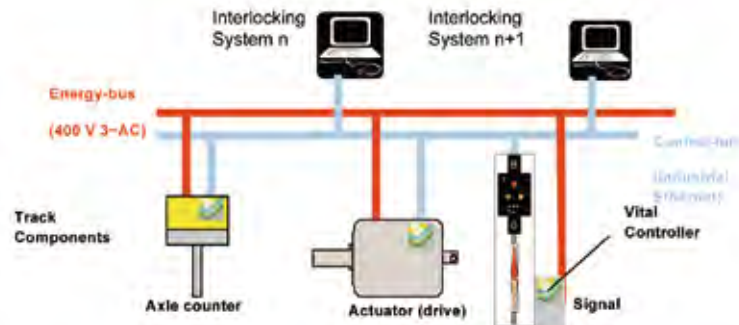

Figure 6.2.1-1: Schematic view of a future interlocking interface for trackside equipment

The benefits of the proposed interface are:

- Separation of control and power cables.
- Standardized interface for all track components.
- Significant reduction of installation costs.
- Decentralized controller, enabling self-diagnosis of track components.
- Condition based maintenance can be realized economically.

The summarized recommendation for the interlocking interface is shown in Figure 6.2.1-2.

#### Further work

The results of the project need to be discussed further in order to find more advo-

cates for the obvious benefits of an open protocol interface.

Next steps are:

- The transfer of INNTRACK results into an functional requirement specification
- The development of prototypes and installation of a significant number of systems under real traffic conditions
- A migration strategy for the introduction of new solutions.

#### References

1. INNTRACK Deliverable D3.2.3, Functional requirements for the open standard interface for electronic interlocking, 13 pp, 2009

	Recommendation	Comment
<b>Communication architecture</b>	Master/slave	
<b>Architecture</b>	Ring or redundant tree	For high availability
<b>Bus-system base</b>	Industrial Ethernet	Standard solution with long-term availability
<b>Safety</b>	Signalling safety protocol	Specific enhancement in Layer 6 of ISO-reference to fulfil the safety requirements
<b>Physical medium</b>	Fibre-optic along track	Media-converter in sub-stations for distribution plug-in of the trackside-components with RJ45 electrical connection
<b>Telegram</b>	Standard data scheme with specific data fields depending on the track component functionality	Unified interface for all trackside equipment
<b>Data transfer</b>	Time-critical processes on realtime channel Other operational data and diagnosis on regular Ethernet data flow	One network for all applications needed for operating the railway infrastructure

Figure 6.2.1-2: Recommendations for an interlocking interface

## 6.2.2 Hollow sleeper

Andreas Ziemann, ConTraffic

More information is available in deliverable D3.2.2

### Background

For many decades no standard for hollow sleepers has been valid throughout Europe. Due to this lack of standard, different national solutions, which are not compatible with each other from a geometrical point of view have been developed and accepted.

The work in INNTRACK is to establish a proposal for a future European standard. The standardized hollow sleeper has to fulfil the following functions:

- To accommodate one or more switch locks
- To accommodate one or more switch mechanisms
- To accommodate heating unit for the DLD components
- To accommodate monitoring elements for monitoring the limit position of the switch
- To accommodate the electronic / control unit for the switch mechanism or for inspection units
- To protect the components from mechanical damage.

### Proposed hollow sleeper specification

The present specification/proposal is based on the requirements of European railway operators to applications of integral switch settings and monitoring systems. The specification is intended as a basis for a European standard.

In specifying the geometrical requirements maximum importance has been

assigned to assuring small dimensions (compact components) so that, especially for the switch setting systems, no restrictions shall apply with regard to mounting, layout and transport. Nevertheless the mounting space should be determined in such a way that the majority of the existing solutions for setting system components can be integrated into the hollow sleeper without difficulty. Preferably UIC 60 stock rail and switches are to be used which is the scope of the INNTRACK project. However, the proposed hollow sleeper can also be used or adapted to other profiles.

The specification/proposal covers in detail:

- Geometric specifications of the hollow sleeper (see Figure 6.2.2-1).
- Functional requirements
- Requirements in terms of availability and reliability
- Description of required tests.

### Further work

Following the work performed in INNTRACK a new project has been started within CEN workgroup WG 16 in order to define a European standard for hollow sleepers based on the INNTRACK results.

### References

1. INNTRACK Deliverable D3.2.2, Functional requirements for hollow sleepers for UIC 60 and similar types of switches, 12 pp (and 4 annexes, 4+1+4+1 pp), 2008

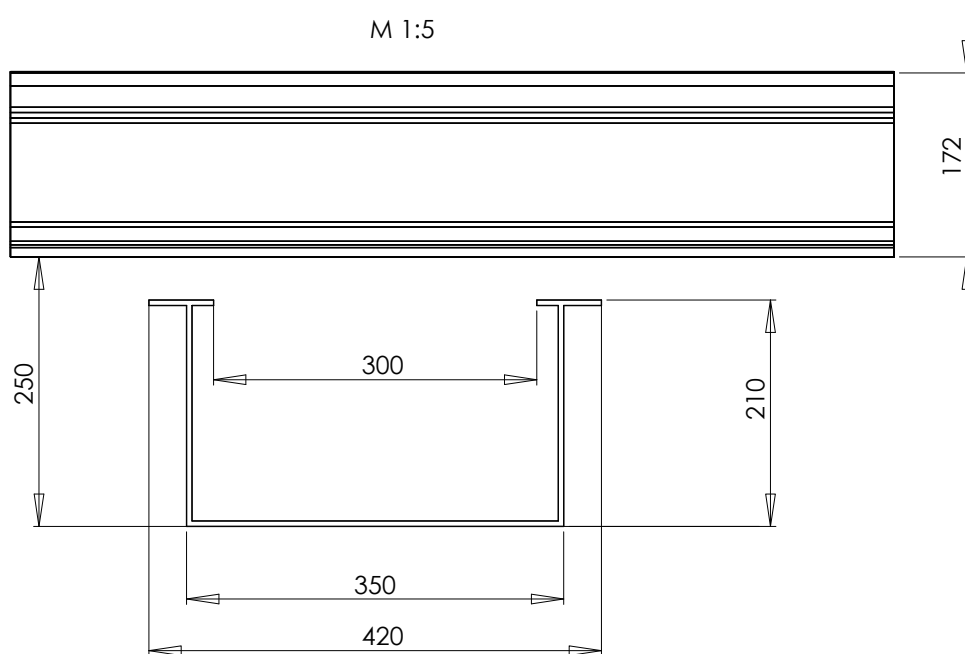

Figure 6.2.2-1: Basic dimensions of the hollow sleeper proposal

## 6.2.3 Technical and RAMS requirements/ recommendations for actuation systems

Andreas Ziemann, ConTraffic

More information is available in deliverables D3.2.1 and D3.2.5.

### Background

Major cost driver for switches & crossings (s&c) are:

- Preventive maintenance
- Corrective maintenance

The components used in Europe to actuate s&c have different performance in terms of Reliability, Availability, Maintainability and Safety (RAMS). Different concepts are used to drive s&c. The position of the actuation points, the requested forces and the types of locking devices vary from country to country.

The work within INNOTRACK aims to collect requirements and detail best practices in order to reach the INNOTRACK target of 30% life cycle cost (LCC) reductions.

### Proposed technical and RAMS requirements

The proposal focuses on UIC 60-300/ 1200 switches. It contains the technical and RAMS requirements listed in Tables 6.2.3-1 and 6.2.3-2.

The position of actuation and detection devices on s&c are defined based on the experience of railway operators and component manufacturers.

### LCC benefits

LCC calculations based on data from two network companies (DB and Banverket) have revealed differences between them. The LCC at Banverket is higher. For both companies a major portion of the LCC cost is spent on maintenance.

An LCC calculation for a target configuration including all driving and locking device (DLD) components with a much higher mean time between failures (MTBF)

and also a higher initial investment shows an LCC cost reduction of 41%. This exceeds the INNOTRACK project goal of 30% reduction.

From this target configuration, the details of the DLD component requirements can be defined:

1. MTBF of DLD components  $\geq$  250,000 hours
2. Service interval = 12 months
3. Regular service time = 1 hour (2 workers)

The LCC target can be achieved by investing in more reliable and less maintenance intensive equipment. For example the position detector (which has the lowest MTBF of all DLD components) could be a fully encapsulated solution integrated into a hollow sleeper. Position detectors with a similar approach are already available (VAE IE 2010). The specifications for such components need to be adapted to the target figures in order to start the development of LCC minimized components.

The actuator used by Banverket was designed and introduced in 1973. The use of equipment designed to fulfil the target configuration has the potential to reduce the LCC of the DLD components by 30%, in line with the objective of INNOTRACK.

### References

1. INNOTRACK Deliverable D3.2.1, Definition of acceptable RAMS and LCC for DLDs, 24 pp (and 1 annex, 4 pp), 2008 [confidential]
2. INNOTRACK Deliverable D3.2.5, Technical and RAMS requirements/recommendations for the actuation system, the locking and the detection device for UIC 60- 300/1200 switches, 17 pp (and 1 annex, 1 pp), 2009

Description	Benefit/Motivation
Auto-diagnostic system with monitoring of operational parameters	Extended maintenance cycles Condition based maintenance concepts possible
3-phase brushless asynchronous motor	Low cost, industry standard motor
Clear separation between power and signal lines	No nuisance trapping on signal line, no switching, higher functionality
Stroke adjustable from 60 mm to 1200 m	Needed for multiple drive points, size UIC60-500 up to 220 mm
Switch not trailable	Simplified driving and locking device (DLD) design, improved safety, harmonized requirements in Europe
Defined and tolerated actuation force	Damage protection of switch blades
Closed switch rail with no gap to stock rail	Safety, less or no inspection, less wear, enhanced mean time between failures (MTBF)
Automatically temperature compensation of the tongue movement (-40 – 70°C)	Allow for tongue movement of ± 25 mm
Open protocol interface	Enabling of condition based maintenance strategies, increased independence from the interlocking system supplier, standardization of components, simplified installation and commissioning of systems

Table 6.2.3-1: Technical requirements

Description	Benefit/Motivation
DLD components integrated in the standardized European hollow sleeper	LCC reduction
Regular inspection intervals	Inspection cost reduction
Inspection time for complete drive	Inspection cost reduction
Automatically tampable switch components	Maintenance cost reduction
No greasing and adjustment of DLD components	Maintenance cost reduction, enhanced availability
No manual operation	Complexity reduction, investment reduction
Each DLD component to be individually replaceable within 30 minutes	Maintenance cost reduction
Switch with DLD assembled, adjusted and tested in the workshop	Installation cost reduction
Locking at the switch blade tip (driver position 1) redundantly mechanical	Safety
Availability on Component level: MTBF > 50 years	Maintenance cost reduction, LCC
MTBF of DLD > 10 years	Maintenance cost reduction, LCC

Table 6.2.3-2: RAMS requirements

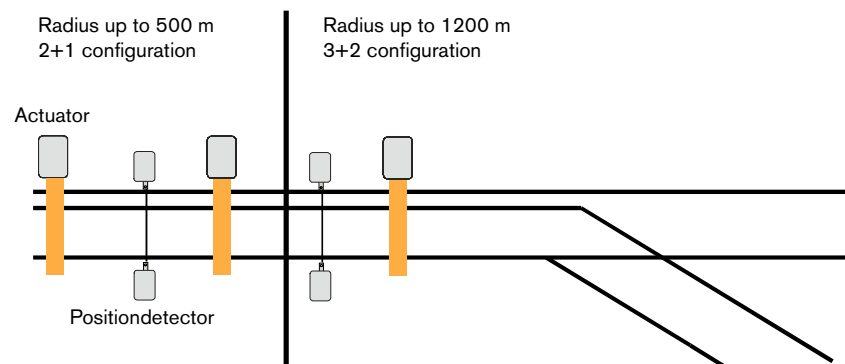

Figure 6.2.3-1: Illustration of the positions of actuators and detection devices

## 6.2.4 Switch monitoring systems

Clive Roberts, University of Birmingham.

More information is available in deliverables D3.3.1, D3.3.2, D3.3.3, D3.3.4, D3.2.4/D3.3.5 and D3.3.6.

The purpose of the work in INNOTRACK was to investigate current and future methods for the condition monitoring of switches and crossings, and to quantify the LCC benefits of using these methods.

### Identification of the key parameters for S&C monitoring

A detailed description of the work is available in deliverable D3.3.1.

Before carrying out detailed work on condition monitoring, it must be acknowledged that it is not practical or economical to measure every single relevant parameter for a relatively complex mechanical system such as an s&c system. By establishing a systems model which expresses the connection between components and functions, it was possible to trace failures through the system to the parameters most likely to show changes when those failures occur.

The following process was followed in order to identify the key parameters:

- Carry out physical and functional decomposition of the s&c system
- Assign functions to components
- Quantify failure impacts by considering failure mode criticality and frequency of occurrence
- Choose failures with the highest impact
- Determine which functions are failing when these failures occur
- Link back from the failing functions to the components which perform them
- Identify the parameters which govern these components

The resulting parameters are all continuous variables which can be sampled at high frequency whenever the switch oper-

ates, resulting in data sets which can be plotted against time and analysed further. The parameters force, displacement, throw time and (for electric actuators) motor current were identified as being critical to the operation of a s&c system.

### Available sensors for S&C condition monitoring

A detailed description of the work is found in deliverable D3.3.2.

Given the key parameters, some suitable sensors were chosen for each one and trialled in the field on the ALSTOM 'HW' type switch actuator, which is commonly used in the UK. It is DC-driven, with integrated locking and detection subsystems. Drive force, switch displacement and motor current were all measured. Some common faults were simulated, and the results plotted to assess the effectiveness of measuring the parameters.

The conclusions of this work were that it is possible, with relatively cheap sensors, to measure significant variation in key parameters during the onset of common faults. 39% of faults reported on this actuator type showed variation in the key parameters when simulated. Not all faults could be simulated because some are abrupt breakages or fractures which would have resulted in damage to the actuator during the test.

### Requirements and functions for S&C monitoring

A detailed description of the work is found in deliverable D3.3.3.

In the interests of providing guidance to infrastructure managers and equipment manufacturers, there was extensive discus-

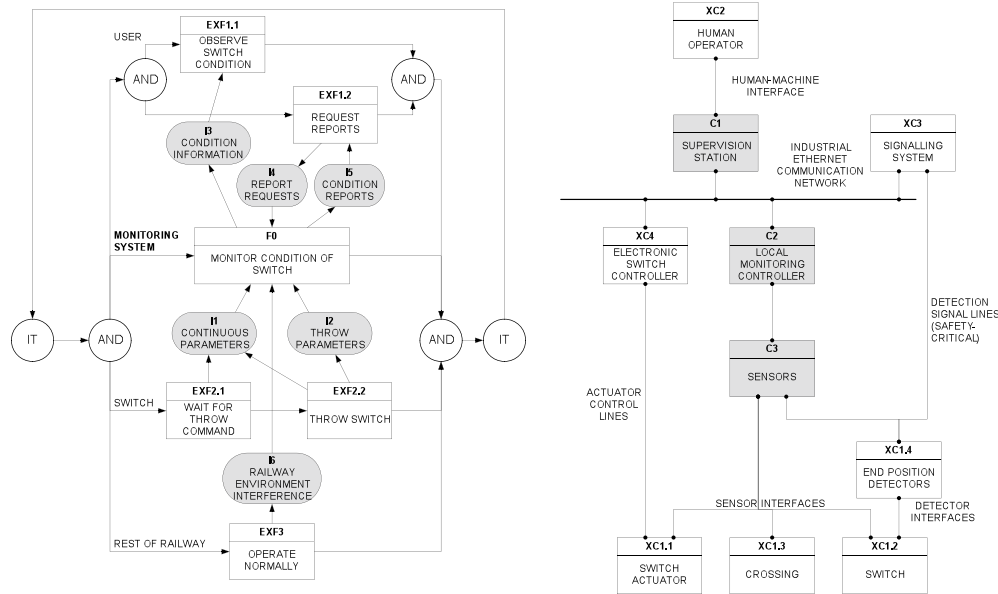

Figure 6.2.4-1: Functional (left) and physical (right) contexts for s&c monitoring systems

sions on a generalised structure for condition monitoring systems. This resulted in a generic specification, consisting of a list of requirements, a functional context definition and a corresponding physical context definition, conforming to the vision of a reduced level of line-side cabling through the use of shared communications media and power feeds. Figure 6.2.4-1 illustrates these standardised contexts, which provide a framework for more detailed design, whilst ensuring some level of compatibility between systems procured by different infrastructure managers, or manufactured by different companies.

#### Algorithms for the detection and diagnosis of faults on S&C

A detailed description of the work is found in deliverable D3.3.4.

There are dozens, if not hundreds, of methods, which have been tried and tested for fault diagnosis of various physical systems, including chemical plants and valve actuators. s&c monitoring has a very specific set of requirements, including human factors such as the need to ensure that

technical staff can understand the system's reasoning and use it as an assistive tool. Fault diagnosis literature was thoroughly reviewed. D3.3.4 contains a general introduction to the field of advanced condition monitoring, followed by a detailed examination of the more established methods. The algorithms currently in use on the railways are also reviewed. Some faults can be detected perfectly well with these simple methods. It is important not to over-complicate monitoring systems by using complex algorithms where simple ones are adequate.

Following on from this review, a new algorithm was developed to address the problem of incipient faults at an early stage of development. This algorithm uses qualitative and quantitative trend analysis to pick out changes to the shape of waveforms from measurements of key parameters. The algorithm was tested on data measured from a s700k switch actuator, a type widely used throughout Europe. The results were very promising, showing a strong ability to detect early trends towards faulty conditions.

#### Requirements for the INNOTRACK demonstrator monitoring system

A detailed description of the work is found in deliverable D3.2.4/D3.3.5.

In conjunction with the work on switch controllers, requirements were developed for the monitoring systems to be installed on the demonstrator switches at Hohen-Neuendorf and Birkenwerder, north of Berlin.

The monitoring system and the switch controller were, to some extent, part of the same physical component and it was therefore appropriate to merge the specifications for these together. As well as functional requirements for the measurement of key parameters, some physical interface specifications were made to ensure that the monitoring system is compatible with the envisaged open standard interface of an Industrial Ethernet (for communications) and a three-phase AC power bus.

#### Quantification of benefits from the monitoring of S&C

A detailed description of the work is found in deliverable D3.3.6.

It is important to be able to accurately quantify the benefits of installing monitoring capability on a switch. For rarely-used switches, it is not likely to be as beneficial to install a high level of monitoring capability as it might be on a critical switch on the approach to a busy station, for example.

A set of capabilities was developed, which defines progressive levels of condition monitoring functionality. These are listed below:

0. The ability to detect when a switch has failed (this is usually part of the signalling system)
1. The ability to detect if a switch is operating out of normal parameters (i.e. fault detection)
2. The ability to determine the type of fault condition present (i.e. fault diagnosis)

3. The ability to calculate the time left until the fault causes the switch to fail (known as fault identification)
4. The ability to schedule maintenance automatically to prevent all failures (condition-based maintenance)

The higher the capability level, the more complex the monitoring system and therefore the higher the cost. An infrastructure manager may choose to match condition monitoring capability to the criticality of failures on a particular switch. For example, a little-used switch on a rural line may only need level 0 or 1 capability to reduce LCC by an acceptable margin; on the other hand, an unreliable switch at a busy junction may need level 4 monitoring in order to reduce disruption, delay minutes and LCC.

It is clear that an infrastructure manager will need a quantitative tool to assist in making these decisions, in order to achieve the optimum deployment of limited investment funds. Two tools were examined in this sub-project, and presented in D3.3.6. Both of these tools were established in Microsoft Excel as spreadsheet calculations.

First, a straightforward LCC calculation tool was developed. It is based on the costs of installing a switch, maintaining it and replacing critical parts when they reach the end of their life. This model was presented by Banverket. The case study for this tool was the INNOTRACK demonstrator switch at Eslöv, Sweden. The LCC of the switch with and without monitoring were compared.

Secondly, a cost-benefit analysis tool, using Net Present Value (NPV) as a measure of cost-effectiveness, was developed around the progressive condition monitoring capabilities. The tool allows the modelling of condition monitoring systems with different levels of capability and with different reliability; that is to say, if it is only capable of diagnosing faults 70% of the time, that can be modelled in the tool

against the reliability of achieving level 2 capability. The tool calculates the number of delay minutes saved over a typical switch lifetime. Since delay minutes form part of the LCC of a switch, the NPV calculation at the end of the monitoring system's lifetime will be positive if the monitoring system has saved enough delay minutes to justify the expense of installing it. This tool can assist an infrastructure manager to experiment with different levels of capability for each switch in the asset base, and an individual solution can be tailored according to the reliability and mission-criticality of each switch.

#### References

1. INNOTRACK Deliverable D3.3.1, List of key parameters for switch and crossing monitoring, 17 pp (and 7 annexes 14+5+2+2+1+1+1 pp), 2008
2. INNOTRACK Deliverable D3.3.2, Available sensors for railway environments for condition monitoring, 28 pp (and 1 annex 8 pp), 2009
3. INNOTRACK Deliverable D3.3.3, Requirements and functional description for s&c monitoring, 22 pp (and 1 annex 5 pp), 2009
4. INNOTRACK Deliverable D3.3.4, Algorithms for detection and diagnosis of faults on s&c, 35 pp (and 1 annex 9 pp), 2009
5. INNOTRACK Deliverable D3.2.4/D3.3.5, Draft requirement specification for the DLD and monitoring demonstrator, 16 pp, 2009
6. INNOTRACK Deliverable D3.3.6, Quantification of benefit available from switch and crossing monitoring, 21 pp, 2009

## 6.3 Benefits from innovative switches & crossings

---

This section evaluates the LCC benefits of the innovative solutions regarding switches & crossings that have been developed in INNOTRACK. It further discusses how the logistics of construction, delivery, installation and maintenance of switches &

crossings can be optimized. These are two key components for any infrastructure manager in implementing the INNOTRACK results. As shown in this section the LCC savings can be substantial if this is done in a correct and controlled manner.

## 6.3.1 LCC evaluation of innovative S&C solutions

Wali Nawabi and Wolfgang Grönlund, DB. Arne Nissen, Banverket  
More information can be found in deliverable D6.5.3

### Background

Regarding switches and crossings, three LCC-calculations have been made. The calculations are based on the same nominal s&c compared to the innovative solution. The estimation is based on an s&c of the type UIC60-760-1:15 (standard s&c for Banverket) or similar. Data for input are based on statistics from Banverket (Sweden), DB

(Germany) and SNCF (France). Traffic data, loading condition and related RAM (reliability, availability and maintainability) figures vary both within one country and between different countries depending on which track section is studied. The given figures are approximations as they represent a mixture of experience from several countries and track conditions.

### Basic data used in the calculations

LCC-Input	Value	Source
<b>General data</b>		
Traffic data	20 MGT/year (Million Gross Tonnes/year)	1
Technical Life Time	500 MGT (25 years)	2
<b>Maintenance activities</b>		
Failure rate	1.5 Failure/year	1
Preventive maintenance	20 maintenance actions/year	1
Mean time to repair (MTTR) for corrective maintenance	0.5 h	1
Mean time to repair (MTTR) for preventive maintenance	1 h	1
Mean Waiting Time (MWT) for corrective maintenance	1 h	1
Mean Logistic Delay Time (MLDT) for preventive maintenance	1 h	1
Replacement of crossing	240 MGT	3
Replacement of switch blades	160 MGT	3
Tamping interval	120 MGT	3
Grinding interval	80 MGT	3
<b>Unavailability data</b>		
Probability for train stop	33 % per failure	1
Train delay cost	80 €/min	1
<b>Cost data</b>		
Investment material cost	125 000 €	1
Investment installation cost	53 000 €	1
Worker cost	50 €/h	
<b>Net present calculation</b>		
Discount rate	5 %	1
Inflation rate	2 %	
Rate used in calculation (1-1.02/1.05)	3.1 %	
Calculation period	25 Years (See Technical Life Time)	

1) Agreed within SP3      2) Litterature: (Zwanenburg 2008)      3) Swedish data

Table 6.3.1-1: Input data for LCC calculations proposed by SP 3, Switches and Crossings

Invention	Investment	TLT*	Corrective Maintenance	Train delays	Preventive Maintenance	Operation	Inspection
Design and material	+ 6%	+ 20%	- 30%	-30%	-30%	---	0%
Driving and locking device	+ 9%	0%	- 80% <sup>1</sup>	-80% <sup>1</sup>	-60% <sup>1</sup>	---	0%
Condition monitoring	+ 4%	+ 20%	-20% <sup>5</sup> -50% <sup>6</sup>	-20% <sup>5</sup> -50% <sup>6</sup>	+20% <sup>2</sup> -15% <sup>3</sup>	+0.3k €/year	-49% <sup>4</sup>

\* Technical lifetime (TLT)

- 1) Only control device and switch device
- 2) Small activity maintenance (adjustment and small repair) increases due to more available condition data
- 3) Larger repair and replacements
- 4) The effect on inspection will be very dependent on each countries legislation
- 5) Only control device
- 6) Only switch device

Table 6.3.1-2: Changes of input data due to invention proposed within INNTRACK.

### LCC models

LCC models are designed for three different cases:

- Design and material
- Driving and locking device
- Condition monitoring

For modelling the three cases, the assumptions in Table 6.3.1-1 are made.

#### Input regarding design and material

Material tests and development of new designs are evaluated in INNTRACK. Results from demonstrator tests will be presented in 2011. Therefore only preliminary data can be used for developing a LCC model. Deliverables D3.1.5 and D3.1.6 have more information on findings and probable outcome of future work:

– By lowering the stiffness in the whole s&c area, wear index and dynamic impact forces can be lowered in the order of 30 – 50%.

In the LCC calculation a reduction of 30% in frequency of maintenance has been used together with an increased technical lifetime (TLT).

#### Input regarding driving and locking devices

Each country has developed their own requirements on locking and driving devices. Therefore many different designs exist today. In deliverable D3.2.1 the designs for Sweden and Germany are described. One finding was that the Swedish DLD was more expensive both in investment and in maintenance. It is stated in the report that a new design will improve the reliability and lower the need for maintenance for both countries. Examples of more reliable component designs already exist, but not yet fully integrated as proposed in the report.

In the LCC calculation a reduction of 60% in frequency of preventive maintenance for the driving and locking device is used. For the corrective maintenance 80% reduction is anticipated as many of the failures are due to narrow tolerances for adjustment, which can be avoided by new design.

#### Input regarding condition monitoring

Experience for different kinds of monitoring equipments has been gained in several European countries. These experiences have not been directly studied in INNTRACK.

Instead the idea has been to extend the possibility to measure different types of conditions and to evaluate measurement data in a new way. The introduction of condition monitoring will deliver benefits for the infrastructure owner but will also add costs for more equipment and for analyzing the acquired data. A general conclusion is that this type of equipment is most beneficial for s&cs where the traffic is intense and the consequence of a failure is high. Deliverable D3.3.6 describes the situation in general and for Network Rail in particular:

- If the consequential cost for a failure is very high then, in general, the most cost effective systems are those that can deliver not only alarms before failures but also schedule preventive maintenance actions based on the condition data and the knowledge of failure modes (fully automated condition based maintenance)
- It is not economical to install the same level of condition monitoring capability on all switches throughout the network. A method for assessing benefits and costs is needed, so that the individual nature of each switch can be examined and the best condition monitoring solution can be chosen.
- Based on data from Network rail, the report states that it is possible to reduce the number of failures by 53%

In the LCC calculation, a reduction of corrective maintenance of 20% for the control device and 50% for the switch device is used. An 20% increase in the small activity maintenance is assumed but for larger replacements and technical lifetime it is assumed that the maintenance is done with better knowledge and therefore the interval of replacement will be longer. The decrease of inspection is based on the assumption that condition data can be used to double the interval between the visits. Condition monitoring also will add a cost for operating the new equipment.

Case	Reduction in LCC-value
Design and material	- 14.9 %
Driving and locking device	- 13.4 %
Condition monitoring	- 5.9 %
Total	- 28.9 %

Table 6.3.1-3: Output from LCC models

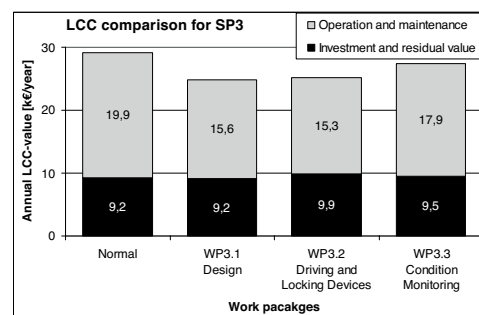

Figure 6.3.1-1: Deterministic output from the LCC-model

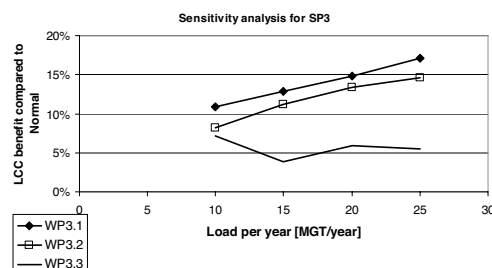

Figure 6.3.1-2: Sensitivity analysis for three different types of S&C inventions

### Output from the LCC model

The output of the LCC is a deterministic value (one value) and is shown in Table 6.3.1-3 and Figure 6.3.1-1. The output for total LCC assumes that the benefits from each innovation can be added, this is not a fact and needs to be checked during the demonstrator period of the project.

In Figure 6.3.1-2 a sensitivity analysis based on the input parameter “Load per year” is shown. The analysis has been clustered to three groups (WP3.1, WP3.2 and WP3.3), see D6.5.3 for details. Unlike those for WP 3.1 and WP 3.2, the magnitude of LCC benefit as a function of load carried (MGT/year) does not show a smooth and contin-

ued increase. Instead the relationship is disjointed since switchblades are renewed (re-investment) once if the load is 10 mgt/year and twice if the load is 11 mgt/year and the LCC calculations are based on the number of reinvestments during the calculation period. Such a situation is better handled by a probabilistic input, which can be used together with Monte Carlo simulations.

The LCC-model is an aid to find cost drivers. Cost drivers can be regarded as either subsystems or maintenance actions. The conclusion so far is that there are at least six areas that can be addressed to lower the LCC of s&cs;

- The technical life time (TLT) should be more than 500 MGT
- The switch device has high cost arising from annual and periodical preventive maintenance and from failures
- The replacement of crossings and switchblades should not be more than one during the TLT
- The cost for grinding and tamping (considered as a periodical preventive maintenance cost) should be analysed to see if it can be lowered

- The cost of inspection is rather high and could be lowered by the use of the proposed solution
- The investment cost is high but the manufacturers could lower their costs and prices through a move towards standardisation amongst users in European countries.

### References

1. INNTRACK Deliverable D3.1.5, Recommendation of, and scientific basis for, optimisation of switches & crossings – part 1, 30 pp (and 2 annexes, 12+12 pp), 2009
2. INNTRACK Deliverable D3.1.6, Recommendation of, and scientific basis for, optimisation of switches & crossings – part 2, 20 pp (and 3 annexes 10+14+16 pp), 2009
3. INNTRACK Deliverable D3.2.1, Definition of acceptable RAMS and LCC for DLDS, 24 pp (and 1 annex, 4 pp), 2008 [confidential]
4. INNTRACK Deliverable D3.3.6, Quantification of benefit available from switch and crossing monitoring, 21 pp, 2009
5. INNTRACK Deliverable D6.5.3, Comparable LCC analysis for SP2 to SP5, Comparable LCC analysis for SP2 to SP5, 35 pp (and 6 annexes 8+4+2+4+4+1 pp), 2009 [confidential]

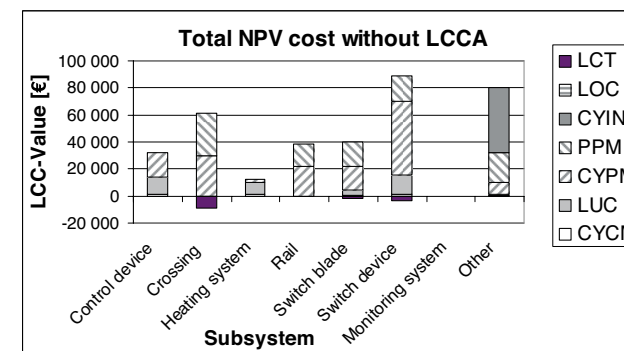

- LCT – Termination cost (=Residual values)
- LOC – Operation
- CYIN – Yearly inspection
- PPM – Periodical preventive maintenance (3 – 30 years interval)
- CYPM – Yearly preventive maintenance
- LUC – Consequence cost (train delays)
- CYCM – Yearly corrective maintenance

Figure 6.3.1-3: LCC-values employed to analyse cost drivers. Each bar stands for one subsystem and the height of the bars for different maintenance actions.



## 6.3.2 Optimised logistics for S&C renewal – contribution to LCC reduction

Paul Richards, Network Rail.

More information can be found in deliverables D3.1.1/D3.1.2, D5.4.1 and D5.4.2

### Background

Novel switch and crossing (s&c) construction and logistics methods have the potential to improve both the rate and quality of installation and to reduce the subsequent need for maintenance, thereby contributing to life cycle cost (LCC) reduction. This work analysed each step of the s&c installation process, with particular focus on the supply chain from component production to final installation. Benefits from optimisation and simplification of the installation process would also be accrued through reduction of the time needed for track closure during s&c renewal. The methodology followed the four phases detailed below:

1. Review of current practice by European IM's for s&c maintenance and renewal logistics, with identification of best practice and logistics work volume baselining;
2. Determination of logistics requirements for novel s&c renewal and predictive s&c maintenance methodologies;
3. Comparison of logistics work volumes for novel s&c maintenance and renewal solutions with baseline for conventional maintenance and renewals;
4. Recommendations for optimisation of s&c logistics strategy to minimise costs of installation, whilst maintaining both the quality of initial installation and lowering the rate of subsequent lowered deterioration under traffic.

Current best practice for s&c renewal and maintenance was established based on the findings from the IM questionnaire programme I combined with more detailed studies of s&c maintenance and renewal practices at Banverket, Network Rail and

Deutsche Bahn, including the logistics required to support these. This was taken as the baseline against which the logistics requirements for novel s&c methodologies were compared, i.e. modular s&c renewal technologies such as pre-assembled s&c panels and half-panels, and pre-assembled slab s&c technologies such as the Corus Steel Slab. LCC reductions were then quantified by comparing the resources needed both for renewal techniques and personnel, plant and possession logistics for the following categories:

- Pre-renewal and preparation activities;
- Removal of old s&c and site preparation;
- Installation of replacement s&c;
- Post-renewal activities;
- Time penalties from possession requirements.

### Increased knowledge, implementable results and related cost reductions

The initial results [2] showed that assembly of s&c adjacent to the worksite is current best practice (and was thus taken as the baseline), with 70% of renewals undertaken by IM's being of this type. A number of fundamental advantages of this technique over piecemeal s&c renewal exist, these being:

- On acceptance of the s&c at the factory, disassembly, transport and reassembly near the renewal site is relatively straightforward;
- s&c can be constructed near to the worksite and installed with minimised disturbance to traffic;
- The quality of components and installed geometry is known to be good upon

commissioning, unlike piecemeal renewals which can result in s&c units with components of varying age and condition.

In identifying the benefits from adoption of novel s&c renewal techniques, it was determined that implementation of a strategy based on the use of the modular s&c renewal technologies studied would have the potential to further reduce s&c logistics costs compared with the baseline through:

- Improvement in the initial quality of installation together with subsequent benefits from reduction in track geometry and component degradation;
- Reduction of life cycle costs;
- Manpower savings;
- Reduction in possession times;
- Immediate restoration of full line speeds;
- Modal shift from road to rail for delivery of components and s&c units;
- Shortening of delivery timescales.

The subsequent analysis [3] provided quantification of the LCC savings that may be realised from implementation of modular s&c renewal techniques, and showed that for the renewal of a single standard switch of type UIC60-EW-500-1:12 on a typical 160km/h conventional line, the LCC savings that could be achieved are:

- 51% reduction in labour hours required;
- 63% reduction in possession times;
- 30% reduction in plant costs.

Additionally, IM's that are implementing modular renewal of s&c are anticipating that the improved installed quality achievable can reduce the rate of service affecting failures by nearly 30%.

### Open questions

Some IM's are already implementing renewal of s&c using the modular renewal technique, and have quoted anecdotal evidence of the potential for s&c life extension through higher installed quality. However, the limited experience and the relatively short timescales since the introduction of modular s&c renewals suggest that further data are required to substantiate the claimed potential for life extension.

Further, it has not been possible to accurately quantify the benefits from reduction of the time needed for line closure during modular renewals. Also costs related to the magnitude and duration of temporary speed restrictions (TSR's) imposed following reopening to traffic are uncertain as wide variations exist in the track access charging and penalty regimes imposed by member states.

### References

1. INNTRACK Deliverable D3.1.1/D3.1.2, Definition of key parameters and Report on cost drivers for goal-directed innovation, 37 pp, 2008
2. INNTRACK Deliverable D5.4.1, First report on the logistics of s&c, 16 pp, 2009
3. INNTRACK Deliverable D5.4.2, Final report on the logistics of s&c, 16 pp (and 2 annexes 1+1 pp), 2009

# LOGISTIC IMPROVEMENTS AND IMPROVED RELATIONS BETWEEN IMs AND CONTRACTORS 7

# LOGISTIC IMPROVEMENTS AND IMPROVED RELATION BETWEEN INFRASTRUCTURE MANAGERS AND CONTRACTORS

Frédéric Le Corre, ALSTOM

The work in INNOTRACK considers logistics from a broad perspective. The term “logistics” then needs to be interpreted in a broad sense since the logistics related LCC costs of an innovative solution includes aspects such as the sourcing practices of the infrastructure managers (IM’s) and the regulatory framework in addition to more core logistic topics such as transportation and assembly.

There have been two main objectives with the work in INNOTRACK. The first objective was to evaluate the current interaction between contractors and infrastructure managers and identify potentials for improvement. The second objective was to analyze the innovative solutions of INNOTRACK in the light of these identified potentials for improvement. More information on this work and the outcome is given in this chapter.

## 7.1 Potential cost savings related to organisational cost drivers

Recent changes, mainly due to a more international approach in the European railway landscape have modified the relation between IM’s and contractors. As a consequence, the scope of each of these actors field of activities has undergone a major evolution. The IM’s scope has shrunk while the supplier scope has expanded.

Figure 7.1-1 gives a schematic overview of this evolution: An increased portion of development work is now requested from contractors and suppliers as compared to the historic situation.

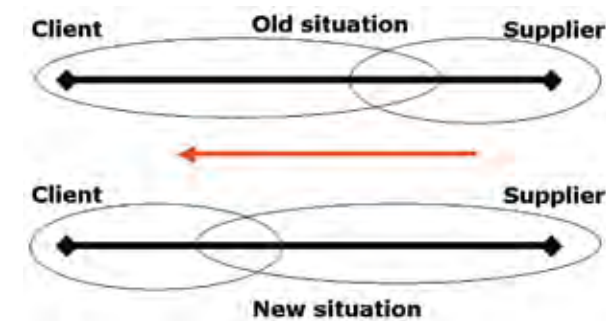

Figure 7.1-1: Evolution of the scopes of development of IMs and contractors

As a result of this change contractors and suppliers cannot limit their scope to the mere execution of work tasks or the supply of standalone products. They now have to integrate their products in a system-wide context and provide related services and guarantees.

In parallel the IM’s have had to adopt a more contractual approach towards contractors and suppliers. This implies a lesser involvement and prescription design of railway products. As indicated in Figure 7.1-1, an intersection between these two scopes remains: there is room for exchange of information and common development.

Since the role of the suppliers now includes a need to ensure and demonstrate the performance of their products in the

entire railway system, their knowledge and understanding of the railway system must increase. In parallel, the IM’s scope will be changed towards a specification of verifiable functional demands, which is a much more complicated task than the traditional role of drafting design specifications. Thus, also the knowledge and understanding of the IM’s needs to be expanded and adopted.

If these requirements are not met, the consequences are illustrated in Figure 7.1-2 where there is no common scope for information exchange. In such a situation the

supplier will not be able to meet the client’s requirements. Such a situation is certain to result in increased cost and reduced efficiency. It is therefore of utmost importance that changes in the market are introduced in a planned and controlled manner. The IM’s, in their role as customers, have to be active and drive the market situation. An illustration of the evolution of the role of an IM is given below based on experience from Banverket.

Banverket is convinced that there is a large potential to do things even better, e.g. by better integration of various disciplines.



Figure 7.1-2: A situation where the decreased involvement of IMs in detailed development is not matched by an increase in the supplier’s involvement.

Banverket now aims for “functional contracts” rather than paying contractors for doing specified work. The underlying rationale is to make sure that contractors are being paid for keeping the infrastructure in a “healthy” condition and to have incentives for contractors who are doing this.

Whilst contractual logic was formerly based on activities, emphasis is now put on “*effects and results*”. In Banverket’s view this reorientation in contract philosophy is not an entirely “*black-and-white*” option, it is somewhat difficult to define merely output-oriented rules and bv still takes some contractual risks, but by-and-large sourcing is now driven by a different logic.

Given Banverket’s experience it is essential to understand the different contractual and supply-chain logics for “*projects*” on one hand and “*maintenance*” on the other. “*Maintenance*” requires more of a partnership approach and a much higher degree of on-going interaction.

For contractors this provides opportunities to establish a presence in a local market, where untypical business may develop towards a situation that originates 50% of revenue from contracts and another 50% from add-ons. For the IM, efficiency arises from the fact that the contract-logic starts encouraging the contractors to do (preventive or even corrective) activities out in the field once teams are out there anyway.

Together with the fact that Banverket has centralized work programming and planning, the new approach has brought some substantial overcapacity of resources (e.g. heavy equipment) to the surface. Local capacity management was, it was found, “*a recipe*” for under-utilization.

Sweden has a good presence of British, Dutch and German contractors (e.g. Balfour Beatty, Strukton, Volker Rail, Leonhard Weiss) and is positive about their contribution to the market vitality.

There is an active longer-term oriented evaluation by Banverket of contractors’ performance, which helps monitor relations.

Contracts now are typically agreed for periods of 5 ( $\pm 1$ ) years. In order to organize the supply-chain in an efficient manner, Banverket follows a policy to have contracts signed 12 months before actual work inception. The maintenance track possessions are also planned a year in advance.

Tendering has started with lower traffic density sections but is now gradually moving closer to denser populated areas. Currently 60% of track-lengths are already contracted under competition.

Regarding funding, Banverket does not have a formal backing by the Swedish government in terms of a multi-year contracts. However there is a valid broad consensus on longer-term needs and Banverket makes commitments accordingly, albeit taking some risks. This is however not seen as really problematic.

New investment is funded on a year-by-year basis, for re-investment – however Banverket can rely on the working hypothesis that funding is stable on established levels. Nevertheless Banverket would agree with the view that long-term contracts could improve efficiency further.

#### The current situation regarding logistics constraints

The previous section gave an overview of currently on-going changes. This section aims at giving a picture of the present situation in order to identify possible ways of improvements. It will focus on the identification of logistics constraints and ways to overcome these. Information on the existing situation was collected from web questionnaires and face-to-face interviews.

The responses obtained indicate that the state-of-the-art for maintenance and renewal logistics practices in European Railways is as follows:

- The majority of IM’s adopts central purchasing of rails, sleepers, ballast and switches & crossings (s&c).
- Most materials are supplied by rail.
- The majority of IM’s make use of call-off contracts for supply of rails, sleepers and s&c. In some countries where crushed stone is widely available, ballast is bought on the ‘spot’ market from the supplier nearest the work site.

- The majority of IM’s use ‘just-in-time’ supply techniques and hold low levels of component stocks as a result.
- The majority of IM’s try to balance planned work against available resources. The majority of IM’s recover used track components and use them again, but with differing degrees of enthusiasm. It can be difficult to make the financial case for recovery.
- All IM’s have responsibility for identifying and specifying the maintenance and renewal work required.
- The great majority of maintenance and renewal work is done in ‘white periods’, when there is no train service. Long blockades of the line do not seem to be common.
- After work has been completed the normal practice seems to be to open the line to traffic with a temporary speed restriction.
- The majority of IM’s work with their contractors to decide what method of work should be used.
- The majority of IM’s will use a track renewal possession to carry out maintenance work as well.
- The majority of IM’s use programmes of rail grinding and rail lubrication to extend track life.
- The majority of IM’s carry out maintenance in-house.
- The majority of IM’s use private contractors for renewal work.
- The majority of IM’s use training courses and examinations to improve and test the competence of their staff.

IM’s identified the following constraints affecting logistics:

- Fluctuating levels of funding from governments, adversely affecting the ability to plan long-term

- The loss of skilled staff through retirement and a shortage of suitable new people willing to join the industry
- The variability of track condition resulting in relatively small and inefficient packages of work unsuitable for high-output methods of working
- A limited number of component suppliers resulting in resource shortages and poor competition.

#### Relations between contractors and infrastructure managers

The interaction between contractors and infrastructure managers has a significant potential for increasing the efficiency of track maintenance and renewal works. The performance of the contractors’ works can be improved by a more collaborative, partnership-based approach with infrastructure managers, aimed at optimizing the use of the available possession times, reducing the costs and/or delivering more for available budget and thus increasing the efficiency of providing railway infrastructure for operators in general.

European practices vary considerably between countries and benchmarking of unit costs (UIC project on ‘Long-lasting Infrastructure Cost Benchmarking’ – LICB) indicates that there is considerable room for improvement. Adopting best practice is therefore crucial for reducing costs and increasing performance of track maintenance and renewal.

The variation in maintenance and renewal costs has been related to outsourcing, yet this is only one of many factors. One of the aims was to see if standardization and the use of a more collaborative approach to logistics can help achieve lower costs, among a very heterogeneous set of European railways.

The numerous findings resulting from the processing of interviews were finally grouped in the following seven clusters, see Figure 7.1-3.

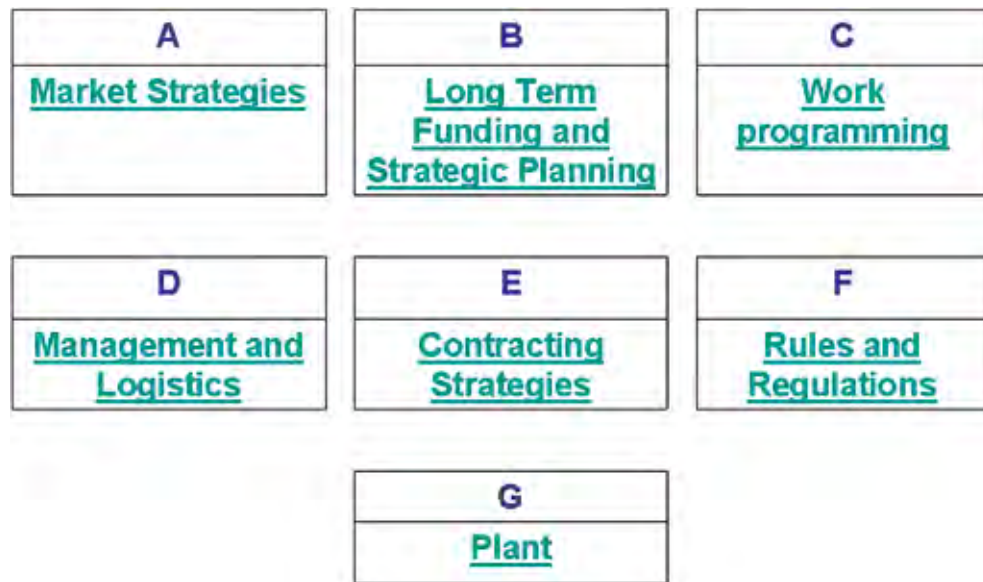

Figure 7.1-3: The seven success-critical areas

There is consensus that the above clusters are success-critical areas for both IM's and contractors but it must be pointed out that there are various degrees of commonality due to some country specific aspects, which may affect the efficiency of potential transfer/implementation of best practices and innovative proposals.

The key findings for each area are summarized as follows:

#### Cluster A – Market strategies

The overarching importance for the contractors is to know the overall strategies of the infrastructure managers to exploit the market for maintenance contracts and renewal projects.

IM's are responsible for make-or-buy decisions i.e. to decide which parts of a contract they wish to perform in-house and which parts they want to outsource/subcontract. However, there are various approaches among infrastructure managers in this regard with little clarity about make or buy decisions. It creates an environment where contractors cannot tailor their capacity to the market until there are clear decisions of IM's to what extent they

will use their own staff and which parts of a contract will be out-sourced.

Current statutes on market openings and degrees of out-sourcing are of great importance to contractors. It differs very much from country to country with some IM's out-sourcing almost all track renewal and maintenance works, while others still execute a great volume of the works (in particular the maintenance) by in-house resources. The opening of market for contractors in Europe is in its infancy and needs a decisive push. Functioning and competitiveness of markets, handling of market-entry barriers are other issues that are limiting the contractors' ability to respond with high productivity and efficiency. As suggested by some interviewees, system partnership business models could improve the current situation.

Active supply market development among equipment suppliers is the other issue which may contribute to the cost reduction of heavy machinery used for track maintenance and renewal.

Finally, from the discussion with IM's and contractors and a joint workshop, it became evident that there is a strong need

for strategic steps in structuring markets. There is no point in IM's and contractors competing for position. A relationship where tasks are done by those who add the most value must be established. Both IM's and contractors expressed needs for openness of dialogue for a true understanding of long-term costs and thus improve the overall efficiency and performance of track maintenance and renewal works.

#### Cluster B – Long-term funding, planning and contracting

In a back-to-back approach, infrastructure managers need long term funding commitments from governments:

- To be able to invest efficiently into the development and maintenance of the infrastructure.
- To meet the demands of the operator/ railway undertaking (RU) for availability of efficient and reliable infrastructure.

IM's need this long term commitment for provision of infrastructure to the RU, and contractors need it to deliver services to the IM's. Simply put "planning stability is at the heart of efficient processes" for all parties concerned.

Long-term planning is fundamental for contractors and infrastructure managers to determine their capacity / machinery and staff for the anticipated market needs. It is very important to avoid over-sized fleets of costly machinery (sometimes by a factor of two) and to assure that highly skilled and trained staffs are available when needed, because recovery of this staff or resourcing for peak capacity may be very costly with serious impact on the costs of works.

It is also vitally important that plans are reliable: they need to be realistic, and accurately delivered.

Current financial planning and budgeting cycles in most of European countries are inappropriate for efficient work programming.

#### Cluster C – Working programming

Understanding of basic economies of resource deployment (machinery and staff) is fundamental to the optimisation of the supply chain. Optimisation of the supply chain interface with contractors (including project risk analysis) is crucial to avoid unpleasant surprises. Hence, transparency and dialogue between IM's and contractors needs to be established at an early stage to develop programmes together with the objective of:

- Building the foundation for the most efficient use of the most important cost drivers
- Addressing risk before it arises rather than resorting to legal disputes afterwards
- Optimising the industry's long-term cost

The fundamental building blocks for good economics of resource deployment with a substantial impact on unit cost are:

- Plant and staff deployment during track possessions
- Well programmed project pipeline and sequencing of plant and staff deployment (logistics from work-site to work-site)
- Minimum disturbance strategies and procedures for assessing the overall costs of the intervention into the track

It is, therefore, vital that framework plans are translated into dependable mid-term work programming.

This should include:

- Consistent sequencing of all works over time and geographically
- Coordination and bundling of activities
- A well programmed pipeline of major projects leading to a "clockwork" approach to worksite logistics and work execution
- Avoiding large programme changes resulting in increase of costs both for supply-side and the execution of work
- Careful attention to all details in planning process and work programming

IM's approach in this regard is a key to create a cost efficient framework, for the execution of works by contractors primarily by:

- mid-term planning and work programming
- consistent sequencing of work
- logistics and execution dependability
- an even workload distribution over the year

According to contractors, the great majority of mistakes occurring during the performance of work are the result of failures during planning. These can be avoided if above principles of work programmings are jointly followed by both IM's and contractors.

There is a high commonality between contractors concerning the above statements on work.

#### **Cluster D – Project management and logistics**

Multiple interfaces on site between IM's and suppliers/contractors introduce cost and undermine responsibility to deliver efficiency. Maintenance and renewal work is often carried out by various parties (e.g. staff of the IM for worksite protection, contractor's staff for work execution) that increases the number of interfaces and the effort required for coordinating work. The currently high variability in working time per possession / output can be improved by step change in both processes and technology.

Due to the fragmentation of work without clearly defined responsibilities for project management, the contractors cannot influence sufficiently the overall efficiency of the project. Moreover, they often have to take the risk for delay in the execution of the work and thus cost due to the disturbances in the logistics, which are beyond their control.

It is therefore vital that project management is clearly defined and assured by a body/person authorised by client and agreed with contractor. Logistics also has to be carefully designed in the overall work programming in a joint effort between IM's

and contractors at a very early stage. All changes in project management and logistics have to be agreed with contractors and risks properly allocated.

#### **Cluster E – Contracting strategies**

Current contracting mechanisms (such as "cost plus", "ad-hoc") often do not include incentives to increase efficiency. Long-term output oriented contracts are a way to enable contractors to dimension their capacities accordingly and to increase efficiency as a result of a steeper learning curve.

Formal, complex, and sometimes unrealistically short tender procedures drive cost in the supply chain. Communication between the contracting parties can be improved so that the scope of work and the risk allocation is facilitated ("open partnership in competition").

Risk allocation and reward sharing is a major area of concern, which can be tackled and improved by appropriate contracting strategies.

The most efficient contracts for IM's and their contractors will tend to be:

- Longer term
- Output oriented
- Incentivised to drive efficiency
- Share risk and reward allocation equitably
- Based on open and honest communications
- Based on fair tender procedures that include sensible timescales and documentation of adequate quality; depending to some extent on individual markets.

As quoted both by IM's and contractors the contracting strategies may have an important impact on the overall costs of the works resulting in up to 10 to 30% reductions.

#### **Cluster F – Rules and regulations**

The differing rules and regulations across Europe are a key entry barrier for contractors to market their services interna-

tionally. Cross-acceptance of certifications for machinery (technical and process) and for innovations would enhance competition and ensure that efficiency gains are rolled-out more easily.

Opening of the market will also affect current overcapacity positively. A more open market would produce more efficient prices, more efficient sizing of capacity and better utilisation.

Sometimes rigid rules for worksite protection and logistics can have a very substantial impact on productivity and costs. Moreover, requirements may be related to the highest technology, safety and staff qualification criteria hindering the cross-acceptance and market opening. They can be also onerous in proportion to the benefits. So there is a need for a harmonisation of rules and standards based on 'good practice'. This would lead to simplification and added value

Furthermore, long-term and obsolete standardisation is an obstacle to innovations. Consequently, there is also a need for processes that encourage innovations rather than obstructing them.

In conclusion, the objective should be to assure wide-ranging cross-acceptance of machinery, works and staff based on a simple and efficient certification processes with far lower costs as present and with reduced time-scales.

#### **Cluster G – Plant**

The cost for moving equipment (logistics) is often very high; it consumes considerable time, often as a consequence of improper planning

Coordination between infrastructure managers and contractors in purchasing and specifications of heavy equipment is essential to avoid over-sized and over-specified fleets.

There are only few manufacturers of heavy machinery on the market. This may also have an impact on costs of contractors' plants.

Some other important issues, partly covered by the previous key findings under

Cluster A to F, but very relevant for the interface with use of plant and machinery are as follows:

- Cost are not just related to the plant, but also to specialist labour force
- Rules and regulations should reflect (or be adopted to regard) both the variability of work-sites and the appropriateness for various conditions
- IM's and contractors competing for production capacity are unlikely to secure best value from a limited number of producers
- Client specifications may also inhibit use of valuable existing plants

The way to further cost reduction of heavy machinery may lay in drafting joint specifications for future fleet, improving in planning of the needs, purchasing policy and homologation/cross acceptance of machinery.

#### **Conclusions and recommendations**

The examples from the comparison of current practices in European countries show that savings between 10 to 30 % are realistic; in some cases the savings may be even higher.

With regard to LCC and in situations where more and more railway networks have problems in achieving their capacity requirements, it is important to emphasize that not only the direct cost of maintenance intervention can be reduced but that also the opportunity costs of train operations can be decreased. Through better utilization of track possessions capacity can be released for train operations through higher process efficiency and increased performance of the contractors. Among the many aspects that were consistently raised in the interviews and underlined by empirical evidence, the major area for improvements can be summarized as follows:

- Contracting strategies of infrastructure managers are vital for efficiency, e.g. long term planning, dependability, economies

of scope and scale, output orientation (innovation, LCC-aspects), terms of employment/build-up and continuity of skills

- Track possession policy is a hot and “efficiency-critical” issue (re-orientation is necessary, vast potential for process-innovation to make better use of availability windows)
- Industrial engineering of processes and worksites should be a prime area of management attention (good practice knowledge management),
- Fleet utilisation for heavy plants is often too low which causes high capital costs and has consequences for initial direct costs of track maintenance and renewal. This is a consequence of that the fleet size of some very expensive machinery is often far above real needs.

- Rules and regulations, particularly in safety and logistics (worksite protection and material supply) have a massive impact on productivity and LCC. In a number of cases there is significant room for improvement on the national level.
- Process efficient friendly European harmonization will add further value through the opening of the market and through standardization and cross acceptance of equipment and practices.

All the key findings and conclusion as summarized above originate from interviews of both infrastructure managers and contractors. Key conclusions were tested and double-checked in joint work sessions with representatives from both sides.

## 7.2 Evaluation of logistics of innovative solutions

### Introduction

As stated above, there is significant potential for increasing efficiency of track maintenance and renewal works by improving the interface between contractors and infrastructure managers. Further, the performance of the contractors’ works can be improved by a more collaborative partnership-based approach with infrastructure managers aimed at optimising the use of the possession times available, reducing the costs and/or delivering more for available budget and thus increase the efficiency of providing railway infrastructure for operators in general. A problem in INNOTRACK has been to find the right organisations within the different IM’s where these questions are dealt with. Since the question is wide there are often several different parties who are handling parts of the question.

### Validation criteria ratings

Detailed evaluation of logistics of INNOTRACK innovations is presented in Chapters 4, 5 and 6 while an overview assessment is presented below. This assessment of the logistics of innovative solutions developed within INNOTRACK was done with reference to the seven clusters considered critical for success. They were crosschecked with each work-package related to the technical sub-projects of INNOTRACK, financial impact and the difficulty of implementation of each Cluster area (A to G) critical-to-success were then analysed and assessed.

This work has highlighted the different aspect covered by each of these seven success critical areas. Some are related to political aspects like A, B, E and F. Some are related to commercial aspects while others are related to a combination of logistics and engineering aspects.

	WP 5.3–Support		WP 5.4–S&C		WP5.5–Rail	
Seven Success Critical Areas	Financial impact	Difficulty of implementation	Financial impact	Difficulty of implementation	Financial impact	Difficulty of implementation
A-Market strategies	M	L	H	M	H	M
B-Long term funding and strategic planning	H	M	H	M	H	M
C-Work programming	H	M	H	M	H	M
D-Management and logistics	M	L	M	M	M	M
E-Contracting strategies	M	L	M	M	M	M
F-Rules and regulations	H	M	H	H	H	H
G-Plant	M	L	H	H	H	H

Table 7.2-1: Financial impact and difficulty of implementation rated as High (H), Medium (M), Low (L).

In conclusion the combination of financial impact and difficulty of implementation for the different sub-projects was found as:

- High financial impact – Low difficulty of implementation: 0 cases
- High financial impact – Medium difficulty of implementation: 9 Cases (Blue)
- High financial impact – High difficulty of implementation: 4 Cases (Red)
- Medium financial impact – Low difficulty of implementation: 4 Cases (Yellow)
- Medium financial impact – Medium difficulty of implementation: 4 Cases (Green)

#### Findings and way forwards

One of the key objectives of INNORACK was a reduction of life cycle costs with 30%. Most of the interviews with both contractors and IM's show possible cost reductions in this order solely from logistics related issues. However, since the statements made in the interviews are not verified and often referring to specific activities it is not possible to draw more precise conclusions.

Within INNORACK, the study has been focusing on success-critical areas, which have a relation and an impact on the logistics and engineering aspects. These are:

- C – Work programming,
- D – Project management and logistics,
- F – Rules and regulations
- G – Plant

Theses have been investigated and reported in deliverables D5.3.2 Final report on the logistics of support, D5.4.2 Final report on the logistics of s&c and D5.5.2 Final report on the logistics of rails. The conclusions in these reports clearly show the potentials of cost reduction.

From the joint workshop held in Paris on 18 June 2008, European Rail Infrastructure Managers (EIM), European Federation of Railway Trackwork Contractors (EFRTC) and Community of European Railway and Infrastructure Companies (CER) have formed joint working groups with the

objectives of addressing the areas which are rather concerning strategic and management levels. Each joint group formed by EIM/CER and EFRTC works on one of the agreed priorities:

- A – Market strategy
- B – Long term funding, and strategic planning
- E – Contracting strategy
- F – Rules and regulations

A major problem is that European practices vary considerably between different countries. The situation is also very complex within most countries. A large number of national practices and laws regulate the situation in each individual country. This means that the transformation process will be much longer than expected. The intention from INNORACK was to address these questions to IM's and industry so that the results of the work on logistics would become a basis for future work and not an interesting "shelf warmer".

The statement of a possible 30% cost reduction, though qualitative, is based on a tangible reality and thus a reasonable estimate. One must also have in mind that benchmarking of unit costs indicates that there is considerable room for improvements. Only in adopting the current best practice there is a significant potential in reducing costs and increasing performance of track maintenance and renewal.

Another conclusion is that a follow up project of the work on logistics in INNORACK is well motivated and needed if different European Union directives like Directive 2004/17/EC of the European parliament and of the council of 31 March 2004 shall have a chance to become a reality in the future.

The work carried out in INNORACK has also improved the understanding among the track contractors of the IM's situation and vice versa. This is perhaps one of the most important outcomes of the work on logistics in INNORACK.

#### References

1. INNORACK Deliverable D5.1.5, Final report on existing states-of-the-art for construction, maintenance and renewal activities and assessment of logistic constraints, 21 pp (and 9 annexes 4+2+4+5+2+2+3+2+6+50), 2008 [confidential]
2. INNORACK Deliverable D5.1.6, Final report on conduct of interfaces between contractors and infrastructure managers and means of improvement, 34 pp, 2009 [confidential]
3. INNORACK Deliverable D5.1.7, Public report on construction, maintenance & renewal activities – conduct of interface between infra managers and contractors and suggested improvements, 14 pp, 2009
4. INNORACK Deliverable D5.2.1, Documented validation procedure, 20 pp, 2009
5. INNORACK Deliverable D5.3.2, Final report on logistics & support, 18 pp, 2009
6. INNORACK Deliverable D5.4.2, Final report on the logistics of s&c, 16 pp (and 2 annexes 1+1 pp), 2009
7. INNORACK Deliverable D5.5.2, Final report on the logistics of rails, 18 pp (and 1 appendix 8 pp), 2009
8. INNORACK - Joint Workshop IM's / Contractors held on 18th June 2008 in Paris.



# TECHNICAL AND ECONOMICAL ASSESSMENT 8

# TECHNICAL AND ECONOMICAL ASSESSMENT

Burchard Ripke and Wali Nawabi, Deutsche Bahn. Anton Lamper, ProRail and Jonathan Paragreen, Network Rail  
 More information can be found in deliverable D6.5.4.

The life cycle cost (LCC) of an asset is one of the most important key values in the decision making process. Life cycle cost analyses (LCCA) at different levels of detail should be the fundamental basis for

- strategic decisions
- decision between different alternatives
- selection of appropriate solutions regarding products and processes
- optimization of existing systems.

LCCA enables a system approach since it includes, besides all costs at all relevant phases, also the technical behaviour of the product as described by RAM(s) – Reliability, Availability, Maintainability (and Safety).

Traceable decisions are only possible with coherent rules. This chapter therefore addresses these rules and describes the procedure of how to carry out LCC and RAMS analysis in a practical way. It picks up important questions and gives recommendation for relevant parameters like discount rate and time horizon. Also the documentation of the LCCA, that is important for traceability of results and further actions, are discussed in this chapter.

Concerning capital budgeting techniques it was shown that the Net Present Value (NPV i.e. Total Present Value in Life Cycle Costing) is the most accurate key value for decision support. A combination of techniques and indicators can also be advisable as a complement to NPV results, particularly estimation of annuity, total costs, break-even or in some cases internal rate of return (IRR) can bring additional useful indications.

The installation of the methodology in the decision process of companies and the use of RAMS and LCC analyses in projects requires knowledge of the experts and the decision-makers about the methodologies. The INNOTRACK guideline for LCC and RAMS (deliverable D6.5.4) addresses different target groups from the top management – responsible for strategic decisions – to the specialists – responsible for technical decisions. For a broader picture of LCC and RAMS analysis it is recommended to also read this guideline.

## 8.1 RAMS and LCC analysis for rail infrastructure

An evaluation regarding the state of the art indicated a low regularity of use of RAMS and LCC and no common understanding of different RAMS and LCC techniques. In the frame of INNOTRACK the methods of life cycle costing (LCC) and RAMS technology are defined and implemented with respect to the infrastructure. INNOTRACK has established a harmonized LCC calculation method at European level, which enables to identify cost drivers, assess the track components/modules and to make cross-country comparisons.

Optimization of track constructions or track components regarding technical and economic requirements is essential for railway companies to fit the market and to compete against other means of transportation. Due to the long lifetime of the track and the track components – ranging between 20 to 60 years – pre-installation technical and economic assessments are necessary to optimize the track construction and get the return on investment (ROI) in a manageable timeframe. LCC and

RAMS technologies are two acknowledged methods for assisting in this optimization process.

LCC is an appropriate method to identify cost drivers and to gather the costs of a system, module or component over its whole lifetime. This includes development, investment, maintenance and recycling costs. Different views and evaluations allow the comparison of different systems and deliver necessary information for technical and economic decisions.

In the field of railways, LCC methods are starting to be implemented and will provide a definite advantage to the IM's in helping calculate costs for the implementation of innovative technologies.

### Why and when to use RAMS and LCC?

An optimization of an existing system or the assessment of an upgrade or an innovation ultimately has to be based on the basis of costs. But these costs are at least related to the (initial) investment, the cost for operation, for maintenance and for

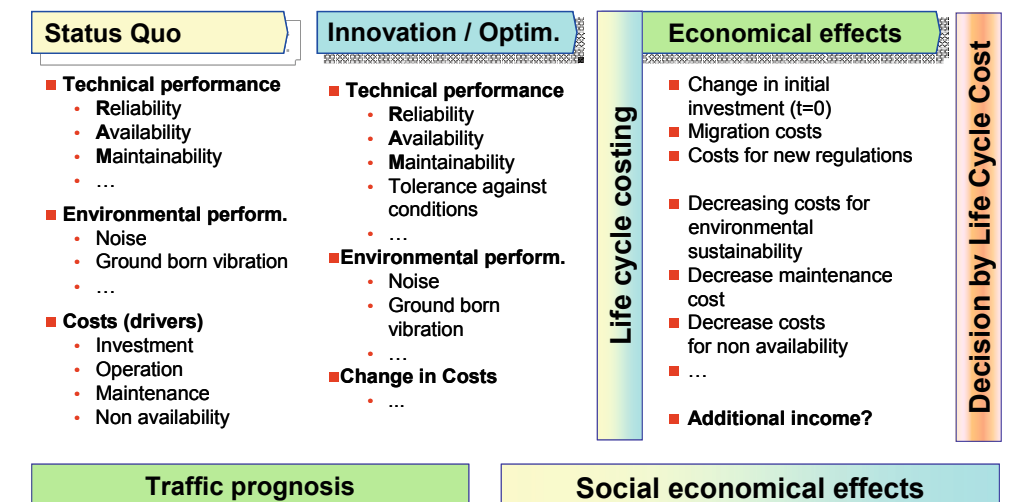

Figure 8.1-1: RAM(S) and LCC analysis for assessment of innovations

non-availability. In case of funding by the government also social economics needs to be considered. The relation between technical and economical aspects together with future requirements often makes a traceable assessment difficult in such a situation.

A structured procedure starting from the technical and economical requirements and the analysis of the status quo using RAM(S) and LCC management and analysis gives goal oriented indicators for the optimization. The assessment of the innovation should employ the expected RAM(S) performance and the resulting LCC as a basis for the decision, see Figure 8.1-1. The straight forward optimization of an existing system requires not only mean values for the life time or failure rates of the different components but the distribution of the long-term behaviour. Often the first appearance of failures is most relevant for the non-availability or needed maintenance of the system. Employing mean values of component lives leads in such cases to an underestimation of the life cycle costs. In addition to the first occurrence of the failure also the shape and spread of the probability density function are important in an optimization, see Figure 8.1-2. In case of a wide spread in the probability density function a technical analysis and improvement is necessary to improve the system behaviour.

The collection and analysis of RAM(S) relevant (key) parameters – the RAM(S) management – is the basis for the technical optimization since it filters out under-designed, over-designed or badly designed components. Together with an LCC analysis the most important cost drivers and necessary improvements can be identified. This structured process guarantees a fast implementation of the improvements and avoids a situation of trial and error.

Another important question is how to achieve the required availability of the system. The availability depends on the technical performance of the system (or

the component) and the repair rate.

Figure 8.1-3 shows as an example of the influence of the repair rate on the availability of a system.

However, both the technical performance and the repair rate influence also the life cycle costs of the system. Therefore the decision whether to change the technical performance of the component or to adjust the repair rate or to do both should be based on an LCC analysis.

Also the question of the economical relation between maintenance and lifetime of the components is important in an economical optimization. In Figure 8.1-4 the influence of the repair rate on the lifetime of the rail is shown. The technical optimum (longest life time of the rail) will be achieved for a repair rate of 0.007. A higher or lower repair rate leads to a decreased life time.

The economical optimum is not necessarily related to the technical optimum. Only a RAM(S) analysis in conjunction with life cycle cost analysis (LCCA) can predict the optimum repair rate taking into account the system requirements and costs.

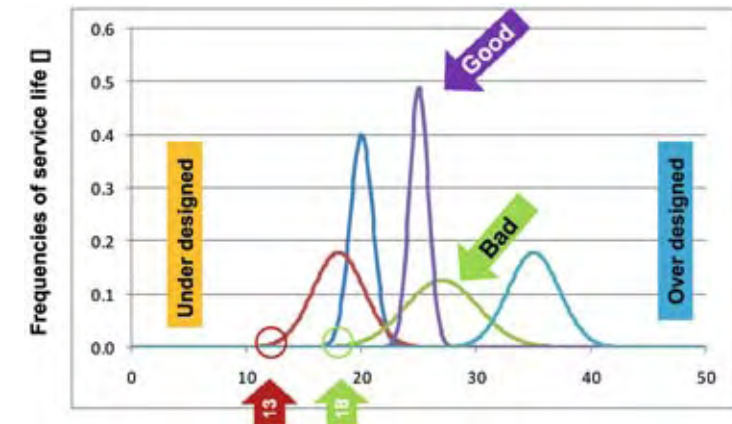

Figure 8.1-2: Probability density functions for service life (years) of several track components

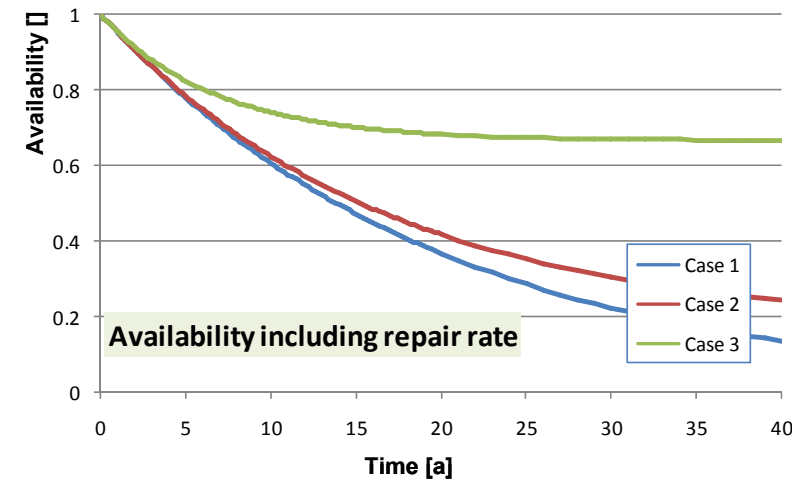

Figure 8.1-3: Influence of repair rate on availability

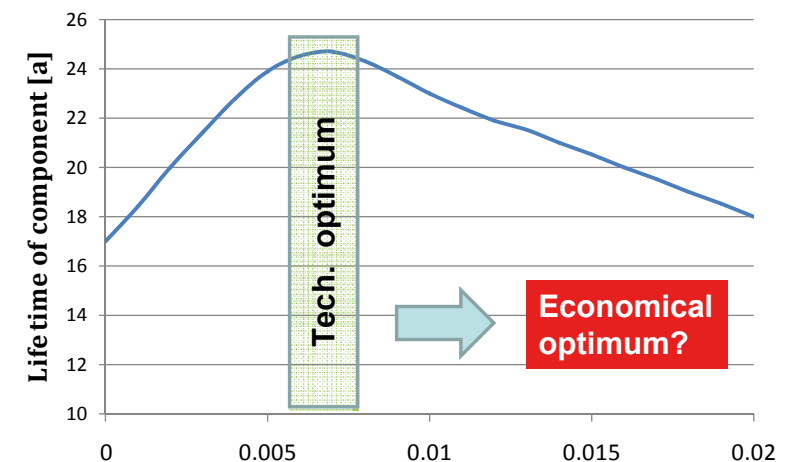

Figure 8.1-4: Influence of repair rate on lifetime of component

## 8.2 RAMS technology

RAMS technology is a recognized management and engineering discipline for the purpose of predicting the specified functionality of a product over its complete life cycle. RAMS technology keeps the operation, maintenance and disposal costs at a predefined accepted level by establishing the relevant performance characteristics at the beginning of the procurement cycle and by monitoring and controlling their implementation throughout all project phases. The RAMS characteristics determine essential parameters of the system such as the usability and acceptability of the system, the operation and maintenance costs, and the users' safety and health risks when operating the system.

RAMS according to EN 50126 is an abbreviation describing a combination of Reliability (R), Availability (A), Maintainability (M) and Safety (S):

- Reliability is defined as the probability that an item can perform a required function under given conditions for a given time interval.
- Availability: the availability of an object being in a condition in order to fulfil a required function under given terms and given period or during an alleged span of time provided that the required auxiliary materials/external tools are available.
- Maintainability: the feasibility that a certain maintenance measure could be executed for a component under existing boundary conditions within a defined span of time, if the maintenance will be made under defined conditions and defined process and auxiliary materials will be used.
- Safety: the non-existence of an unacceptable damage risk.

The EN 50126 (Railways applications – The specification and demonstration of reliability, availability, maintainability and

safety (RAMS) describes the engineering, construction, use and demolition of a railway system from the perspective of RAMS. Rail infra projects executed by infrastructure managers must meet the standard EN 50126.

### The V-model according EN 50126

The V-model (or VEE model) is a systems development model designed to simplify the understanding of the complexity associated with developing systems. In systems engineering it is employed to define a uniform procedure for product or project development.

The V-model is a graphical representation of the systems development lifecycle, see Figure 8.2-1. It summarizes the main steps to be taken in conjunction with the corresponding deliverables within a computerized system validation framework. The downward line of the V-Model contains the project definition, a constant interchange of user and functional requirements, configuration and technical specifications. This is a decomposition from the global level until a detailed design is eventually generated. The upward line reverses the sequence of project test and integration (installation, validation and acceptance of the system including the acceptance by the maintenance department). Continuing with monitoring of the systems performance and the modification, the model ends with the disposal after the end of the lifetime of the system.

### Setting up a RAMS analysis

The starting point of a RAMS/LCC analysis is to establish which question that has to be answered with the analysis or, alternatively, which questions that have to be solved and how can they be solved.

In general, the target of a RAMS analysis consists in:

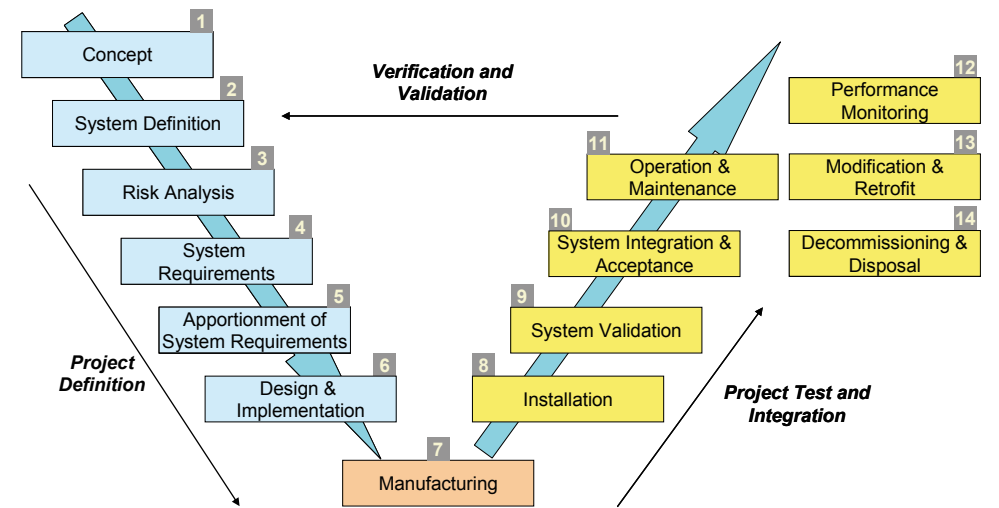

Figure 8.2-1: V-model according EN 50126

- prediction of reliability by failure rate analysis and
- prediction of serviceability and availability by maintainability analysis

The components determining the system functionality are defined by the requirements of the customers, which in turn are described by the RAMS parameters. They will affect the reliability and total performance of the system. In a narrower sense, all requirements are greatly influenced by the reliability. It is therefore essential to define the RAMS and LCC specifications very clearly and to fix these in contracts with manufacturers and contractors as far as possible.

Thus a project starts with a set of functional requirements. The right key parameters have to be described and identified. The defined specifications and the key parameters are project specific and serve to solve the questions of the concerned project, e. g. to predict the future performance and costs or to select the solution which best meets the requirements/needs of the customer.

The aim of defining the specifications is to define the problem to be dealt with. A

procedure to answer the overall question “Which RAMS parameters are taken as a basis and which goals should be achieved by the RAMS analysis?”. could be to:

- first find out how to obtain RAMS specifications
- secondly to define RAMS specification starting at a top level
- then proceed with detailed specifications in each ongoing phase

By the determination of the RAMS objectives, the parameters taken from the system requirements/specifications have to be stated more precisely. Usually requirements are described in reference to Mean Time Between Failure (MTBF) and in terms of different availability parameters (e.g. measured in hours of train delays). If there are no detailed specifications regarding the RAMS parameters, the following questions could be helpful as a starting point:

- Availability: To what extent is the system/track available for the operation/use? This can for example give a guarantee of track availability without traffic interruptions, i.e. that maintenance activities are carried out outside of operating times.

- **Reliability:** What kind of failures occur and how often? Provides knowledge of the system/track behaviour to be analysed regarding failure rates and wear implying impact on operation and lifetime of the system/product/component.
- **Maintainability:** How good is the system/track maintained? Helps to identify an optimal maintenance strategy.
- **Safety:** What consequences do the failures have? Identifies safety relevant functions.

At the end of the analysis a reference should be made to the specifications fixed before the analysis. For the example the reference for the case described above could be:

- **Availability:** The availability of the system/track is assured, since there are no operational disturbances, which cause limitations of track operations.
- **Reliability:** The amount and nature of the failures are identified. Based on this further conclusions can be made.
- **Maintainability:** An optimal maintenance strategy could for example be an indication regarding the grinding interval.
- **Safety:** The focus is here not primarily on safety issues, but on an LCC and RAMS analysis since we assume that the railway uses suitable and safe devices

In the next section there is a summary of commonly used parameters for RAMS specifications.

#### Parameters for Reliability

Parameters in common use are failure rate ( $\lambda$ ), Mean Time Between Failure (MTBF), Number of failures per month/per year, and Number of failures influencing train operations.

Failure rate ( $\lambda$ ) is the probability of failure per unit of time of items in operation; sometimes estimated as a ratio of the number of failures to the accumulated operating time of the components. The failure rate is usually time dependent, and thus the rates change over time ( $t$ ) during

the expected life cycle of a system.

$$\lambda(t) = \text{failures} / \text{time unit}$$

The failure rate is thus the frequency with which an engineered system or component fails, expressed for example in failures per hour. In the special case when the likelihood of failure remains constant with respect to time, the failure rate is simply the inverse of the Mean Time Between Failure (MTBF), expressed for example in hours per failure.

Mean Time Between Failure (MTBF), is a basic measure of a system's reliability. It is typically represented in units of hours. The higher the MTBF number is, the higher the reliability of the product.

Related reliability parameters are MTTF (Mean Time To Failure), MTBM (Mean Time Between Maintenance, which is used for preventive maintenance), MTTF (Mean Time to First Failure).

#### Parameters for Availability

Each infrastructure manager has its own key performance indicators regarding availability. The availability can be measured for example in train delay (hours), total train delay, train delay caused by infrastructure, train delay caused by a specified infrastructure asset, and the punctuality of passenger and freight train.

A definition of train delay could here be if the train is more than 5 minutes late. A primary delay is a delay that directly affects the train. A secondary delay is a delay caused by a primary delayed train. The terms knock-on delay and cascading delay are used synonymously with secondary delay.

It is generally very difficult to rate non-availability costs in an LCC model.

#### Parameters for Maintainability

Parameters in use are: Mean Time To Repair (MTTR), Mean Time Between Maintenance (MTBM), Mean Time Between Repair (MTBR), Mean Maintenance Hours (MMH), Mean Down Time (MDT) and Mean Logistic Delay Time (MLDT).

Mean Time Between Maintenance (MTBM) is the average time between all system maintenance actions. Maintenance actions may here be preventive actions or repair.

Mean Time Between Repair (MTBR) is the average time between corrective maintenance actions, which require the removal or replacement of a subsystem.

Mean Time To Repair (MTTR) is the sum of corrective maintenance times divided by the total number of repairs of an item. This measure indicates the average time to fully repair a failed system – it includes detection of failure(s), removal and replacement of the failed component(s) and final check.

MTBM, MTBR and MTTR are just basic measures of maintainability. Complex systems, like railway tracks (or railway infrastructure as a whole) usually need combinations of these basic measures and also other means of evaluation to assess the maintainability.

#### Parameters for Safety

Parameters in use are Hazard rate, Number of accidents, Number of derailments, Number of accidents due to external sources, Number of accidents due to internal sources, and Incidents that could have led to accidents/damage.

A quantitative analysis produces a quantitative measure of the safety level in terms of personal hazard (e.g. risk of fatality per time unit or per train kilometres) and/or social hazards (e.g. total number of fatalities per year or frequency of major accidents).

The safety aspect is largely outside the focus of this chapter. Nevertheless, the safety aspect needs to be considered in specifications for components and equipment.

#### Current state of RAMS practice

The use of RAMS analysis in track and structures is currently limited. Where it occurs it is in an early stage. This is in contrast e.g. to the signalling sector where RAMS is more employed. The reason is the complexity of the track system and the tradition of the

track and civil engineering. The complexity stems from several sources. One is the interaction of several railway areas (track, s&c, catenary, signalling, etc.). A second complication is the vast need of data for a proper RAMS analysis. This data is often hard to define and scattered between different databases and organisations. In other words, there exists a lot of measured data in the track sector, but this data is seldom easy to obtain and often difficult to compare between railways since they are defined/measured in different manners. Furthermore it is not obvious which data that is relevant for RAMS analysis. Additionally, geographical distribution of assets and various influences of the environment increase the complexity.

More basic development is therefore necessary before RAMS analysis can become fully functional in the railway community. Results from the analysis carried out within INNOTRACK identifies several areas where development is needed.

## 8.3 LCC analysis and models

Infrastructure managers and industry managers make a multitude of decisions that ultimately are cost related. Since decisions today have effects over centuries in the railway sectors it is important that the cost impact of these decisions are evaluated in a stringent manner. In this regard LCCA and RAMS are the appropriate methods. LCC analysis is primarily a method for decision making through economic assessments and comparisons of alternative strategies and designs.

Life cycle cost analysis (LCCA) is a structured method to assess all costs incurred within a given system during the technical life cycle considered for this system. The classic LCC phases of production are shown in Figure 8.3-1:

- concept and definition
- design and development
- production
- installation
- operation and maintenance
- disposal

### LCC cost elements

As visualized in Figure 8.3-2 the LCC model consist of a 3 dimensional matrix that includes:

- a breakdown of the product to lower indenture levels (PBS),

EN 60300-3-3	LCC Cost Matrix
Development	Procurement (incl. Disposal)
Construction (Prototype)	
(Test)	
Production	
Installation	Operation, Maintenance, Non-availability
Operation	
Decommissioning	see Procurement costs
Disposal	

Figure 8.3-1: Life cycle phases according EN 60300-3-3

- a cost categorisation of applicable resources such as labour, materials, equipment, etc. (CBS)
- a time axis or division in life cycle phases where each activity performed is allocated to a cost element

The CBS is a tree structure of duty and costs that occur during the entire life cycle of a product. The PBS is a hierarchical tree structure of components that make up a product. The PBS clarifies what is to be delivered by the project and can help build a work breakdown structure (WBS).

Setting out from EN 50126 the structure was changed to the cost matrix shown in figure 8.3-3. This standardised cost matrix for LCC is used as the basis for assessment in INNOTRACK and describes all costs. The main focus was here on the unification of the used terms, which allows comparisons of cost blocks between different calculations. Another important point is the standardized form of explanations of the LCC regarding data and uncertainties. The life cycle costing is carried out based on the defined cost matrix with predefined cost items.

### Discounted cash flow or present value method

Cash flow is an important measure in planning and controlling, and for checking financial budgets. The cash flow method accounts for the fact that there are other possibilities to spend the money. To be comparable, cash flows have to be discounted to the same instant in time, usually the starting point of the study period. The time before (time to market) could also be included to compare different alternatives.

The sum of the discounted costs is the net present value (NPV), see Figure 8.3-4 and 8.3-5. As can be deduced from the formula in figure 8.3-4, the chosen value of the

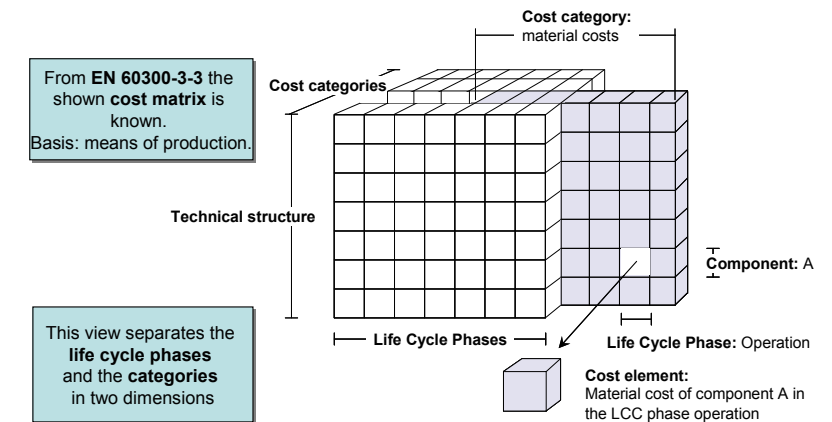

Figure 8.3-2: Dimensional cost matrix of LCC (cost element concept)

I. Procurement	II. Operation	III. Maintenance	IV. Non Availability
I.1 Preparation - one-time	II.1 Service	III.1 Inspection and service (track)	IV.1 Planned
I.2 Preparation recurrent project-specific	II.1.2 Energy	III.2 Maintenance - preventive	IV.1.1 Malfunctions
I.3 Investment		III.4 Maintenance - corrective	IV.1.2 Delays
I.4 Imputed residual value		III.7 Design and system support	IV.1.3 Serviceability
I.5 Decommissioning / retraction / sale / removal (tasks)			IV.2 Unplanned
I.6 Disposal / recycling			IV.2.1 Malfunctions
I.10 Other costs	II.10 Other costs	III.10 Other costs	IV.2.2 Delays
			IV.2.3 Serviceability
			IV.10 Other costs
V. Social Economics			
V.1 Energy consumption		V.3 Delay	
V.2 Environment		V.10 Other costs	

Figure 8.3-3: LCC cost matrix for railway infrastructure analysis

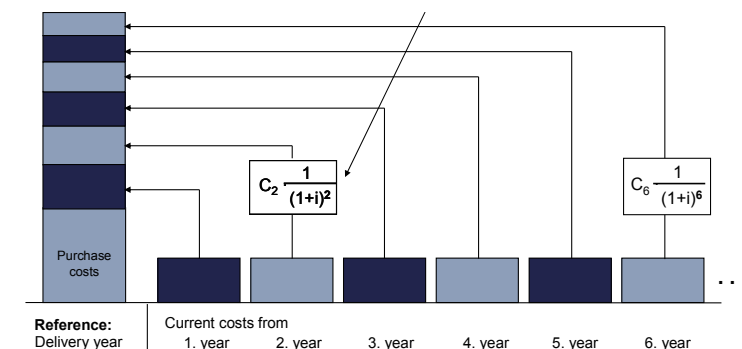

Figure 8.3-4: Annual costs

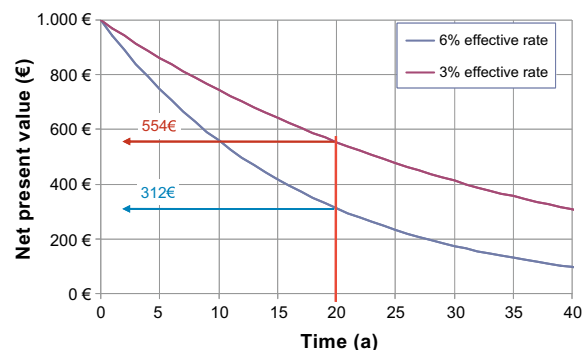

Figure 8.3-5: Discounted value of a payment of 1000 € at different periods for 3% and 6% discount rate

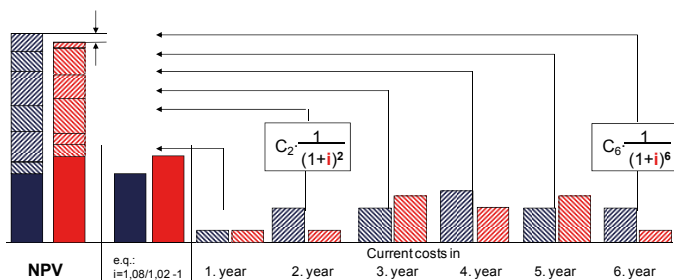

Figure 8.3-6: Annual costs for two alternatives, discounted with 5.9%

discount rate,  $i$ , has a serious impact on the result of an LCCA.

This effect of the discount rate on the net present value is shown in figure 8.3-5. For selected effective interest rates of 6% and 3%, an investment of 1000 € in year 20 results in a NPV of 554 € and 312 €, respectively. A payment in the first year will be not discounted and has therefore an important impact on the total LCC.

Calculating the yearly potential means to calculate the NPV for all alternatives, subtract the value of the reference alternative from the innovative alternative and calculate the annuity. One benefit of LCC is that cost blocks could be eliminated if for both alternatives time and costs are equal. If all annual costs should be used for budget planning, this simplification is not allowed.

In the case of comparison of two alternatives with large differences in initial investments the selected discount rate is mostly the key for the decision. Only in the case of a very significant reduction of maintenance cost in the first years the

higher investment will be balanced if a high discount rate is used (see Figure 8.3-6). In this case the version marked in red is favourable over the life cycle even for an effective discount rate of 5.9% despite the higher investment costs.

#### Discount rate and time horizon

Within an LCC analysis all payments – also future payments – will be referred to a reference date using the discount rate. The question within INNOTRACK was which discount rate and study period that should be used for the LCC calculations. As examples NR takes 6.5% as an effective discount rate for infrastructure, whereas DB uses 5.9%, see Figure 8.3-7.

As an altered discount rate may change a decision, it is important to adopt a correct discount rate in order to obtain a proper evaluation of innovative solutions. Taking into account the long service life of the railway infrastructure and the fact that investments risks in infrastructure are low, a discount rate that depends on the serv-

BV	4.0 %	
DB	5.9 %	For infrastructure
NR	6.5 %	
ProRail	4.0 %	
Public investor	≈ 4.0 %	
Private investor	5.0 % ++	Depending on risk
InnoTrack	≈ 4-5 %	For comparison

Figure 8.3-7: Discount rates in LCCA for different investors and IM's

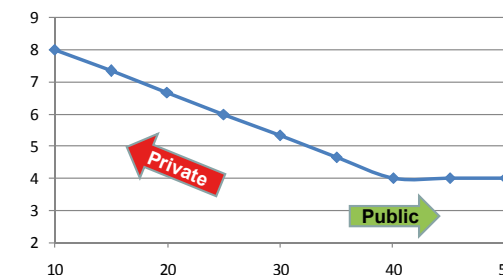

Figure 8.3-8: Proposed discount rate as a function of asset life

ice life of asset is proposed. Figure 8.3-8 shows an example where the discount rate has been established as a function of the service life of the asset. In general LCCA will be carried out with a constant rate for all components included in the analysis. The use of different rates for components with different service life is possible, but will increase the complexity of calculation and documentation.

In LCCA a high discount rate will tend to favour investment alternatives with low capital costs, short life cycle and high recurring costs. On the other hand, low discount rates will tend to favour high capital costs, long life cycle and low recurring costs. Due to the fact that also after an improvement the income will not increase an LCC motivation of innovative solutions is in general not possible at high discount rates. Figure 8.3-9 summarizes the results of an LCC analysis taking into account different effective discount rates. A break-even point between the reference and the innovative solution is given for an effective discount rate equal to or less than 4%.

For higher discount rates the higher investment cost for the innovation leads to an increasing gap to the reference.

Current experience in European infrastructure projects appraisal has shown that there are three other important key issues that strongly affect the results obtained. These are:

- The selection of appropriate discount rate (financial and social)

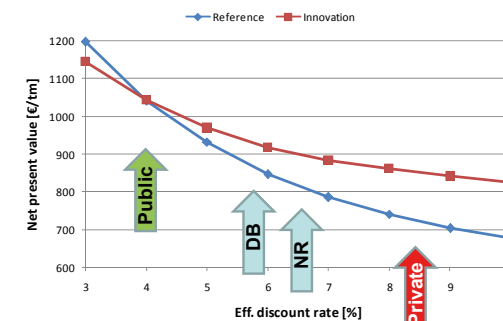

Figure 8.3-9: Influence of discount rate on NPV

- The definition of time horizon for the project
- The evaluation of the residual value of the investment

The accuracy of an economical evaluation is also very sensitive to the accuracy of the cost estimation (for both investment and operational costs). Improvement and homogenization of these techniques (e.g. at a European level) would bring further confidence in obtained results.

In the same way as for the rate of return, the choice of a correct period of consideration also highly affects the results of NPV calculation: Depending on the cash-flows distribution, a project can move from negative to positive NPV just by changing the project time horizon. In the same way, a project can become inferior or superior to another alternative simply by adjusting the period of consideration. Also in the case of this factor, important differences can be found over similar infrastructural projects.

An in-depth evaluation of current practices concerning discount rates and time horizons for infrastructure project appraisal was performed. Most recent bibliographies on the subject shows that, among the diversity of criteria and values adopted, there is a tendency to use reduced values for discounting combined with large periods of consideration. A detailed theoretical analysis led to the following decisions for INNTRACK:

- to consider a variation of 3% to 5% for the discount rate, with a reference value of 4%
- to consider a range of 30 to 40 years as time horizon, with 40 years as a recommended upper bound for larger investments on ballasted tracks assessed through LCCA (closely linked with an accurate estimation of the alternatives residual value).

The discount rate of 4% for long-term investments will ensure profit over the whole period and will give the innovation the chance to change the railway in a positive way.

The consideration of the residual value of investments is a key issue to avoid distortions due to different time horizon criteria. According to cost-benefit guidelines,

residual value is considered as a liquidation value of the project and should include the discounted value of all expected net revenues after time horizon. Therefore it should be calculated in two ways:

- Considering the residual market value of fixed assets, as if it were to be sold at the end of the time horizon considered – includes future net incomes generated by the project.
- Considering the residual value of any other current assets and liabilities.

Figure 8.3-10 illustrates an appropriate calculation of the residual value for two alternatives. The time horizon for the LCCA is 40 years. The technical life time of alternative A is 50 years and for alternative B 40 years. The financial value of the assets will be linearly depreciated over their technical lifetime. The residual value (RV) of the assets is calculated according to

$$RV = V_{Asset} \frac{TLT - TH}{TLT} = V_{Asset} \left(1 - \frac{TH}{TLT}\right) \quad (8-1)$$

Here  $V_{Asset}$  is the value of a new asset, TLT is the technical lifetime and TH the current time horizon.

In the case of variant A the residual value is 1/5 of the asset value and in case B only the scrap value where the costs for disposal have to be taken into account.

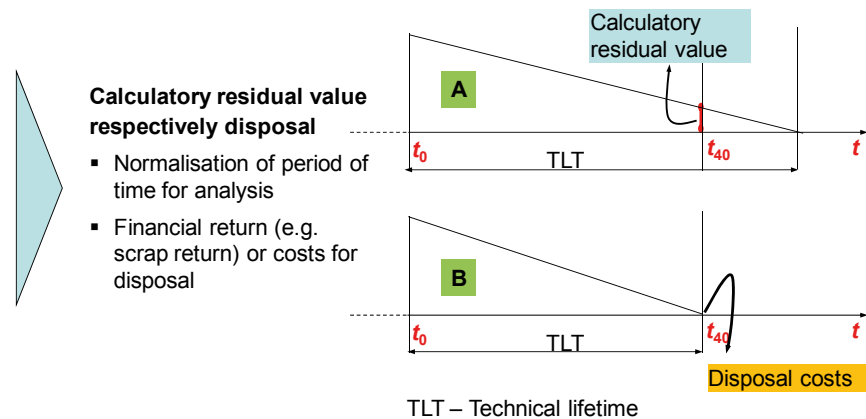

Figure 8.3-10: Residual value – principal approach; alternatives with different life times

## 8.4 Definition of boundary conditions

The identification and definition of the boundary conditions that will affect the chosen RAMS/LCC parameters is very important. A clear and standardized documentation of all assumptions and parameters is absolutely essential for a traceable analysis and for comparable results.

The defined boundary conditions can be visualized as an In/Out frame as described below. This frame clarifies the range and defines the base of the boundary conditions to be analysed. The more clear and accurate the boundary conditions are defined and documented, the better the LCCA.

In addition to the definition and assessment of relevant parameters, data collection and processing are the most important part of a RAMS and LCC analysis. It is also important that RAMS data are followed up.

The analysis within INNTRACK confirms that the use of key values for LCC and RAMS is in a development phase and that there is a need to develop measurable key values for RAMS and LCC.

### In/Out frame

The definition of the impact of each innovation should refer to what is new (general description) and an identification of which specific cost elements the innovation affects (including the breakdown of this effect) within a reference cost matrix. The result can be visualized in an In/Out frame (Figure 8.4-1) where one can identify the cost elements that will be part of the LCC calculation and therefore will require a detailed clarification and possibly breakdown.

The In/Out frame assures that the appropriate boundary conditions are fixed and the question of what is within the calculation and what is not is made clear. It also gives the possibility to put some fields on the frame. These need to be clarified during the LCC analysis.

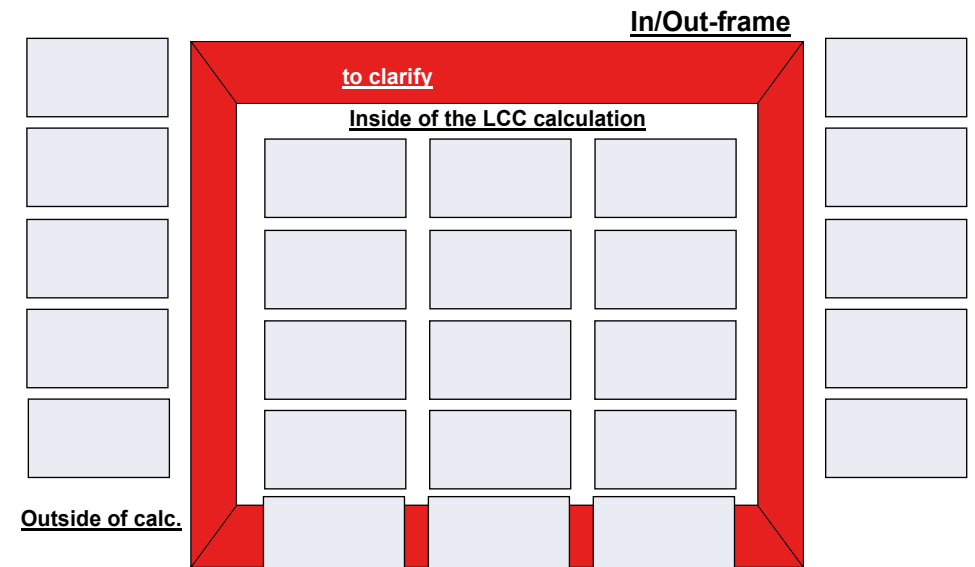

Figure 8.4-1: In/Out Frame for documentation of boundary conditions



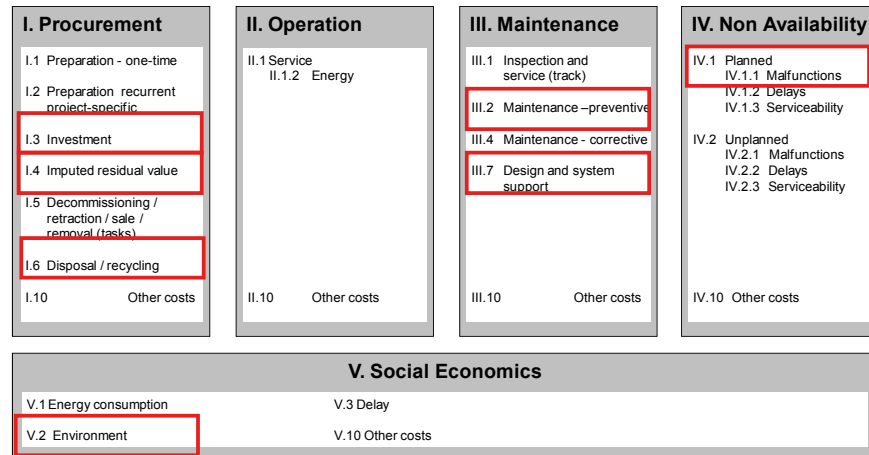

Figure 8.4-2: Visualization of used cost elements – top level

### Cost elements

Also the employed cost elements should be marked at least at the top level of the cost matrix to visualize the scope of the LCCA (see Figure 8.4-2).

### Important technical parameters

Technical parameters relevant for the analysis related to the technical performance and pertinent costs should be documented in a table as shown in Figure 8.4-3. This documentation also includes details about rates and time horizon.

### Important economical parameters

Economical parameters relevant for the LCCA should include details about costs, cycle of payments, source and quality. An example is given in Figure 8.4-4.

Parameter	Reference case	Innovation A
Technical Parameter 1		
Technical Parameter 2		
Technical Parameter 3		
Technical Parameter ...		
Technical Parameter n		
Remarks		
■ Nom. discount rate: ___ %	The nominal discount rate should be based on asset life	
■ Mean inflation rate: ___ %	The inflation rate should be estimated from the last years	
■ Effective rate: ___ %		
■ Time horizon: ___ years:		

Figure 8.4-3: Documentation of relevant technical parameters

Cost block	Data structure	Reference case	Innovation A
Investment	Euro Cycle Source Quality		
Operation	Euro Cycle Source Quality		
Maintenance Activity A	Euro Cycle Source Quality		
Maintenance Activity B	Euro Cycle Source Quality		
Maintenance Activity C	Euro Cycle Source Quality		

Figure 8.4-4: Documentation of relevant economical parameter

## 8.5 Processing and determination of LCC data

The most important part of an LCC calculation is the processing and determination of the LCC data. DB has defined a number of milestones for an LCC analysis. These are shown in Figure 8.5-1.

The first step of an LCC and RAMS analysis is to define the question or problem to be solved, to fix the boundary conditions and to conceptually formulate the goals/requirements of the analysis. The next step is to proceed with processing and determination of (LCC/RAMS) data. Data quality and data availability are here the major problems. It is also important that collected LCC and RAMS data are followed up.

From the LCC model based on the cost breakdown structure (CBS) and the product breakdown structure (PBS) an evaluation of the alternatives can be done. NPV, annuity and the break-even-point are here used as the primary key values for the decision making process and the base for formulating a recommendation.

Manufacturers and contractors can only be accountable for their product if the RAMS and LCC specifications are clearly defined and fixed in contracts with them. Therefore a contract implying mandatory LCC aspects is recommended. In this context monitoring and verification of LCC/RAMS results should not be neglected.

In the frame of INNTRACK methods for LCC and RAMS analysis are defined and implemented for infrastructure projects. The established LCC calculation method has been harmonized at a European level, which enables the identification of cost drivers, assessment of track components/modules and cross-country comparisons. The generated structures and the modular LCC models are a good base for further development in terms of LCC and RAMS analysis with focus on application and benefit of the methods. Basically a better – common –



Figure 8.5-1: Defined milestones of a LCCA at DB understanding of LCC and RAMS between IM's and industry has been achieved in INNTRACK.

As mentioned, the state-of-the-art analysis and further analysis in INNTRACK have shown that firstly LCC and RAMS are rarely used for decision making during the procurement process in the track and structure sector. Secondly, the decision makers (technicians, controllers) are not aware of the matter that especially decisions in the early phases of the product life are very important.

Costs that can be affected (e.g. by maintenance measures) throughout the product's life phases are defined in the early phases of the product life cycle; the literature mentions a range between 80–90%. RAMS and LCC analyses are not carried out for all life cycle phases, but mainly for the investment, operation and maintenance phases. As a consequence the potential LCC savings are not as high as in the earlier phases like construction and planning phases.

We need to notice the fact that the significant part of LCC is fixed before the installation phase. This is where the highest potential for savings exists. Thus the focus should be on the design and production phases when we want reduce the operational costs. Figure 8.5-2 shows the key phases for life cycle costs.

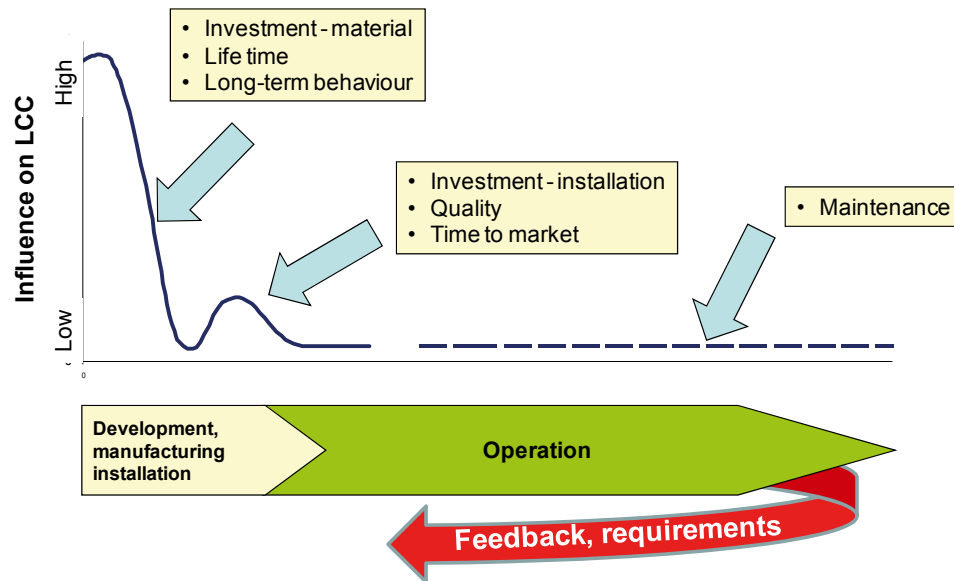

Figure 8.5-2: Key phases for reduced LCC

Very seldom suppliers of components or systems operate their products in advance. Therefore they do not have enough knowledge how their products behave in reality. To obtain better performing products in the railway system, it is therefore necessary to obtain high quality feedback from the operators to the supplier. This is a further reason why projects like INNOTRACK are so important.

#### Increasing loads

An LCC analysis should take into account and evaluate a system not only in terms of economic effects but also regarding the capability for significant improvements to address future needs, such as increasing loads in the near future.

The calculation is starting at the operational time for specific conditions. The load will govern e.g. maintenance intervals. Here, an increased reliability results in increased maintenance intervals that can be accounted for in the LCC model. The planner/ decision maker for a system has to take into account that the final solution lasts for a long period. For already existing systems it is the same procedure. The

standard recommends technical solutions; the selection has to handle the prognosis of increasing load, speed, etc.

In INNOTRACK increased loads and environmental effects have been taken into account in the LCC analysis. The influence of track loading on LCC has been demonstrated in the evaluation of the embedded rail slab track solution (BBERS). For higher loading, the LCC of slab track is relevantly lower than for ballasted track.

#### Uncertainty of parameters – sensitivity analysis

Not all the necessary parameters are well known. These uncertainties will influence future cash flows. There are different kinds of uncertainties, such as

1. unknown values of parameters due to missing data for existing systems,
2. uncertain values of parameters due to lack of experience with new components or systems,
3. parameters like life time of components, failure rates and maintenance intervals that are not constant but described by a probability density function (PDF)

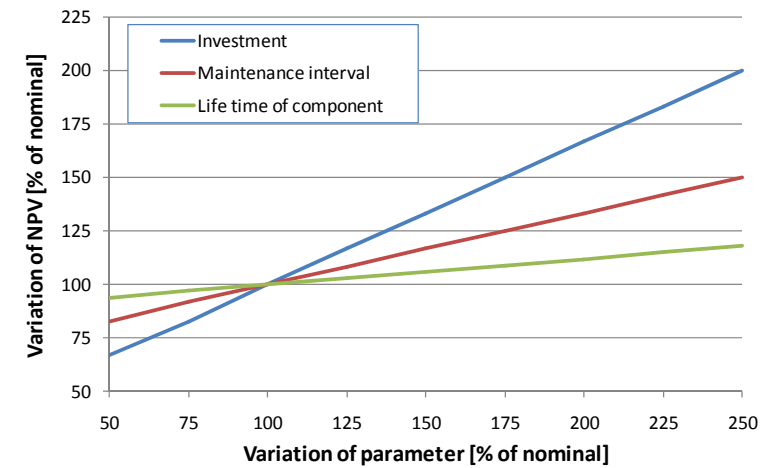

Figure 8.5-3: Example of sensitivity analysis for a specified maintenance parameter

For the first of these three cases a *sensitivity analysis* helps to identify the impact of the uncertainty and to focus the further analysis.

The idea is to vary the input parameters for the LCC analysis and to compare the results in relation to the input. Figure 8.5-3 shows as an example the change of NPV as a function of the variation of input parameters. The NPV and the variation of the input parameter are plotted in percentage of their nominal values (100%). In this example the investment cost and the maintenance interval have an important impact on the predicted life cycle costs. By contrast the unknown lifetime of the component has a negligible influence on the results in the analysed range of uncertainty.

These results indicate that more analyses are necessary to reduce the uncertainty of unknown values – in our example the investment costs and the maintenance interval. If it is not possible to achieve better input values for the LCCA it is necessary to carry out a set of calculations within the specified range of values.

This kind of calculation is also necessary if the values of the parameters can not be described satisfactory by mean values. In general maintenance activities or re-investments are necessary if a failure occurs.

If the failure rate is described by a probability (defined by a PDF), maintenance activities and hence related costs can also be specified by the PDF. If the model contains more than one uncertain parameter that is described by a PDF, a Monte-Carlo-simulation can be used to obtain the probability of different life cycle costs as described below.

#### Probabilistic approach - Monte-Carlo simulation

The Monte-Carlo is very powerful to manage uncertainties on the values of the input parameters in LCCA.

In the *first step* the technical and economical uncertainties have to be identified using expert estimations.

In the *second step* the impact on the predicted LCC should be analysed using a simple sensitivity analysis as shown in Figure 8.5-3. The result of this analysis helps to focus further work on relevant parameters.

In the *third step* the probability density functions that represent the probability of possible values have to be defined. Different distributions are possible such as triangular distribution, normal distribution, log-normal distribution, uniform distribution or Weibull distributions (see Figure 8.5-4).

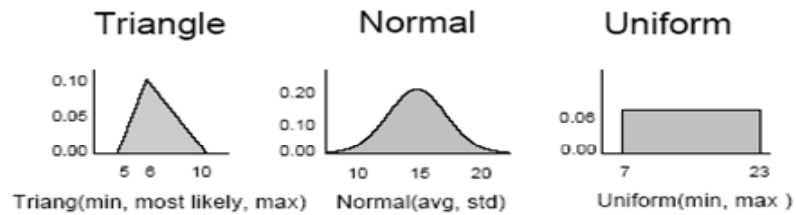

Figure 8.5-4: Examples of probability density functions

The definition of the distribution functions should be done on the basis of a RAM(s) analysis, data bases or expert estimations.

The *fourth step* is now to run the Monte-Carlo simulation with appropriate LCC tools like D-LCC. Figure 8.5-5 shows a schematic of Monte-Carlo simulation.

The *fifth and last step* is the interpretation of the calculated results (Figure 8.5-6). The results can be plotted in different views like

- probability distribution function of NPV for the different alternatives or
- cumulative probability distribution of NPV for the alternative.

As you can see in Figure 8.5-6 all variables of the calculation including the discount rate can be described with a PDF.

Depending on the PDF of the different technical and economical variables in the LCCA, the PDF of the resulting NPV differs between the alternatives. The probabilistic approach identifies risks and opportunities and also helps to focus on further data analysis or technical improvements.

#### Selection of LCC-model

In detail the following steps have been carried out in INNTRACK (see also deliverable D6.5.1):

- Definition of LCC and RAMS methodologies with focus on application and benefit of the methods:
  - CBS (Cost-Breakdown-Structure) with the cost matrix as a base
  - PBS (Product-Breakdown-Structure)
  - In/Out frame for definition of the boundary conditions

- Establishment of discount rate and study period for LCC calculations in INNTRACK
- As a result from a tool benchmark D-LCC was selected as the most appropriate LCC tool for the purposes of INNTRACK
- A framework for the development of modular LCC models to compare innovative solutions with reference configurations:
  - Definition of reference and innovative systems with fixed boundary conditions and relevant parameters
  - Development of the structure for building LCC models with the software D-LCC
  - Identification of global parameters and tables, and definition of a fixed structure by a consistent identification of included items
  - Definition of the technical structure (PBS) and identification of the relevant cost parameters (CBS) for the modular LCC models
  - Modeling of increasing requirements (load, tonnage) and environmental effects
  - Indication of LCC input data by using templates (global parameters, tables containing costs items, and technical parameters)
  - Import and incorporation of the template data into the LCC models
  - Technical validation of the innovative solutions
  - LCC calculations on the basis of the collected data

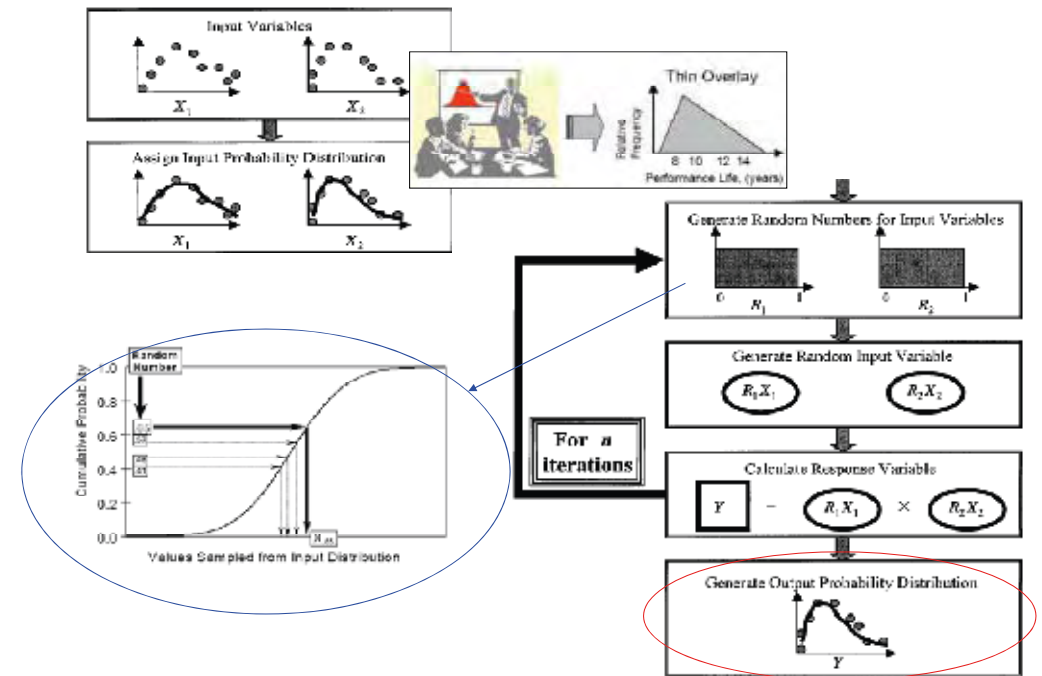

Figure 8.5-5: Schematics of a Monte-Carlo simulation

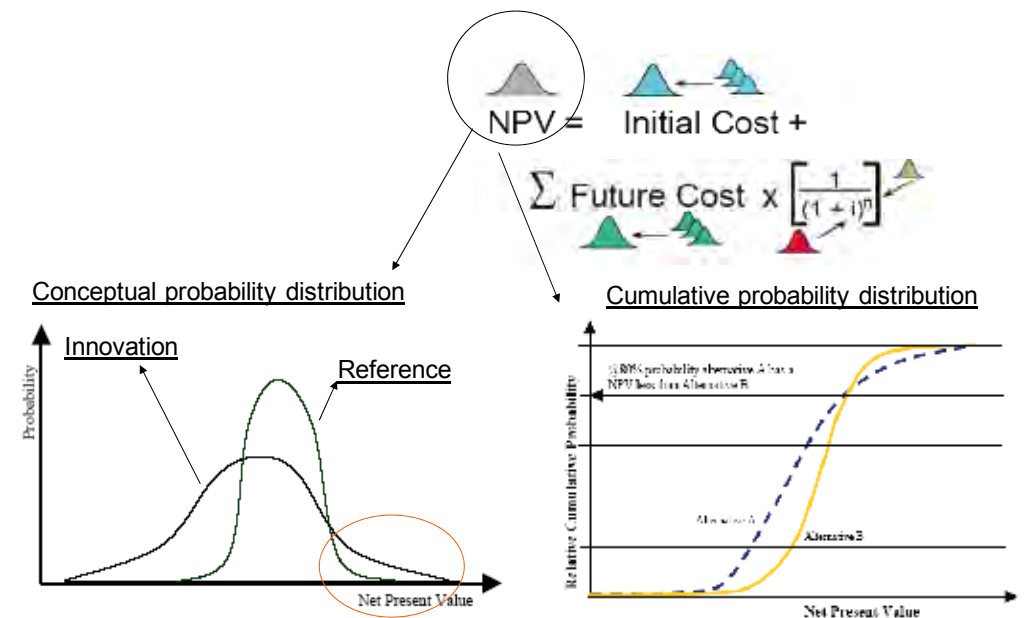

Figure 8.5-6: Schematic interpretation from a results of Monte-Carlo simulation

## 8.6 Technical verifications

---

As mentioned LCCA is strongly influenced by the technical behaviour of the studied system (in the reference configuration and with innovative solutions incorporated). The technical behaviour of an existing system for existing boundary conditions can be measured or identified using RAMS-management. More problematic are the cases of new/modified systems/components, or when there are changes in the boundary conditions such as faster trains or higher axle loads.

In these cases, where there is no practical experience, some systematic work has to be carried out before the LCCA. Looking at other industries several methods are available to minimize the risks of implementation and to maximize the knowledge about a new product or process. One good approach is the use of the failure mode and effect (and consequence) analysis (FME(C)A). This method supports a structured assessment process and a traceable documentation of the product and its

improvements. The active work of different experts in several workshops supports an open discussion and shares the knowledge about the new product or process in a good way. Depending on the question a system-FMEA and/or a product-FMEA and/or a process-FMEA can be carried out. Several standards for FMEA exist for example in the aircraft and automobile industry.

In this analysis the use of low and high resolution simulations, are very useful to characterise the technical behaviour of a new product and to identify open questions and possible technical risks. Especially the comparison between a known and a new system (or component) often leads to an acceptable accuracy in the simulation results.

## 8.7 Economical verifications

---

In general the economical verification of an LCCA is not possible in the short-term. To ensure a reliable LCCA the following steps are necessary:

1. Definition of relevant parameters and influences – if possible in a system approach
2. Documentation of all parameters including source and quality
3. Identification of the sensitivity of the results regarding the variation of the input parameters in front of the LCCA
4. Definition and implementation of a LCC-/RAMS-management to get LCC relevant data from operation
5. After the LCCA and the implementation of the selected solution, LCC management is necessary to provide LCC relevant data at different levels of detail. This LCC-and RAMS-management not only verifies the LCCA but also supports the infrastructure manager to identify cost drivers and related root causes.
6. A feedback loop between the LCC-/RAMS-management and the LCCA ensures validation and improvement of the employed databases and the quality of subsequent analyses.

Only the consequent comparison between planned and achieved behaviour of the system, module or component leads to a fast increase of traceable knowledge and guarantees the quality of an LCCA. Thus the implementation of LCC and RAMS as powerful strategic methods will only be successful if LCC-/RAMS-management is implemented too.

## References

INNOTRACK Deliverable D6.1.1, Incorporated rules and standards, 16 pp (and 13 annexes 25+1+1+1+1+1+1+1+1+1+1+1+1+4+2+1+2 pp), 2007

INNOTRACK Deliverable D6.1.2, Models and tools, 24 pp (and 2 annexes 7+2 pp), 2007

INNOTRACK Deliverable D6.2.1, Unique boundary conditions, 35 pp, 2007

INNOTRACK Deliverable D6.2.2, Benchmark of LCC tools, 28 pp (and 4 annexes 11+17+5+2)

INNOTRACK Deliverable D6.2.4, Database and requirements (as input for WP6.5), 29 pp, 2009

INNOTRACK Deliverable D6.3.1, Boundary conditions for RAM(S) analysis of railway infrastructure, 38 pp, 2009 [confidential]

INNOTRACK Deliverable D6.3.2, Requirements for RAMS analysis of railway infrastructure, 22 pp, 2009 [confidential]

INNOTRACK Deliverable D6.3.3, Necessary developments of RAMS technologies, 21 pp, 2009

INNOTRACK Deliverable D6.4.1, Key values for LCC and RAMS, 20 pp (and 1 annex 17 pp), 2009

INNOTRACK Deliverable D6.4.2, Models and monitoring methods for LCC and RAMS relevant parameters, 24 pp (and 5 annexes 2+4+2+8+1 pp), 2009

INNOTRACK Deliverable D6.5.1, Modular LCC/RAMS models for SP2 to SP5, 30 pp (and 4 annexes, 4+25+8+3), 2009

INNOTRACK Deliverable D6.5.3, Comparable LCC analysis for SP2 to SP5, 35 pp (and 6 annexes 8+4+2+4+4+1 pp), 2009 [confidential]

INNOTRACK Deliverable D6.5.4, Guideline for LCC and RAMS analysis, 101 pp (and 3 annexes 10+2+2 pp), 2009

EN50126, Railways applications – The specification and demonstration of reliability, availability, maintainability and safety (RAMS)

# OVERALL COST REDUCTION 9

# OVERALL COST REDUCTION

John Amore, Network Rail & Björn Paulsson, UIC

## Approach in overall cost reduction

The objectives of INNOTRACK are explained in detail in Chapter 2. Fundamentally the project set itself the goal of demonstrating a 30% reduction in life cycle costs (LCC) of track infrastructure. This chapter summarises the findings from an evaluation of the potential overall reduction in LCC that can be obtained through implementation of a range of INNOTRACK innovations.

A precise calculation of the savings achieved by implementing the innovative solutions from INNOTRACK is not feasible. There are a number of reasons for this. One major reason is that every infrastructure manager (IM) has a different maintenance policy. In addition, each route or track segment will have different degradation rates due to its traffic density and characteristics, the geophysical and environmental factors, the quality of original installation and the subsequent maintenance. This makes the establishment of references cases towards which the innovative solutions are to be matched very cumbersome. In addition, the cost of service disturbance due to infrastructure failure depends on the traffic volume and the time available for maintenance. These factors are route dependent. It further depends on the estimated cost per minute of delays, which in turn depends on the country and route.

The maintenance cost distribution in Figure 9-1 is derived from annual costs excluding investment extracted from the accounting system of Banverket. A full LCC analysis would cover all costs over the total lifetime of a system or product, including investments prior to operation. Such an analysis would be strongly dependent on the chosen discount rates. A complete LCC analysis of all costs on all lines in the network would be theoretically possible. However it would

require significant resources to obtain necessary data (if they are at all available). Further the required LCC model would need to be very complex. So far, such a complete analysis of all detailed costs has not been produced for any of the participating IM's. Instead a simpler approach has been adopted to estimate the overall LCC savings. This model is detailed in the INNOTRACK deliverable DI.4.8. The main idea is to scale up LCC from studies of selected INNOTRACK innovations to the whole network, and then compare the expected impact on the full system against actual cost data for the existing infrastructure. This approximate solution is valid unless there are significant differences in the capital investment required by the present and proposed technologies. Clearly if the innovative solution involves a significantly higher investment, an LCC saving can only be obtained if the innovative solution results in significantly reduced maintenance costs and/or a longer operational life.

Several of the innovative solutions from INNOTRACK have been assessed using a standardised LCC process that has been developed within INNOTRACK. This LCC calculation method is based on best LCC practices at a European level and has been assessed internally and externally. The work on applying the detailed LCC analysis for each innovation to a national network level as mentioned above had the objective of investigating the overall impact of INNOTRACK deliverables on the track infrastructure costs of four IM's. In addition, the study also provides the IM's with an overview that is a powerful tool in prioritising implementation of the INNOTRACK results.

The innovations that have been LCC evaluated in this overall study and the corresponding methods of analysis are shown in Table 9-1.

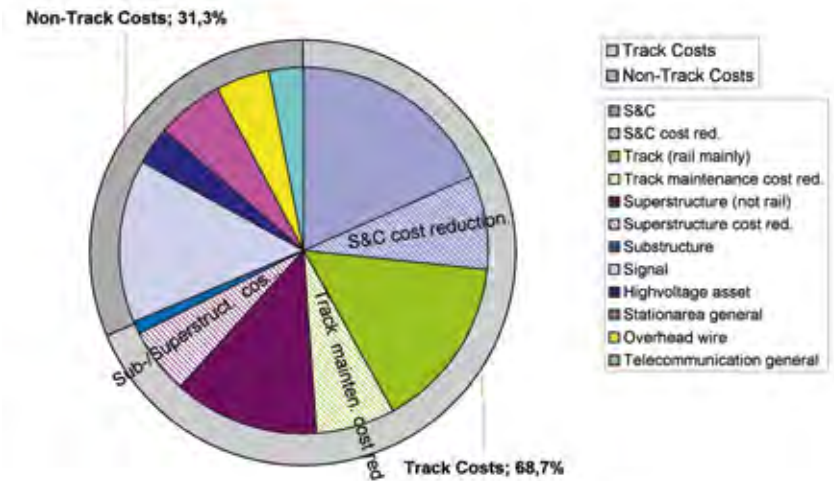

Figure 9-1: Example of maintenance cost distribution from Banverket. For simplicity a possible 30% cost reduction has been demonstrated by assuming an equal 30% reduction in annual maintenance cost of the largest cost groups.

Infrastructure Manager	Banverket	DB	NR	SNCF
INNOTRACK innovations considered	S&C – New designs hollow sleepers, RCM	Slab track	Premium rail grinding & lubrication	Sub grade treatments, soil strengthening
Method of analysis	INNOTRACK LCC model combined with qualitative analysis of benefits	INNOTRACK LCC model	NR RCF/Wear model and NR LCC analysis	Case study cost/benefit analysis using INNOTRACK LCC model

Table 9-1: Summary of the LCC analysis approach in the overall assessment of cost reductions

## 9.1 Savings in sub grade treatments, soil strengthening

In the following areas LCC calculations to assess cost savings have been adopted:

- Low bearing zone (France)
- Soil strengthening under existing railway embankment (Sweden)
- Transition zone (Spain)

The LCC savings achieved are reported in Chapter 4 and the deliverables referenced therein. Only the final results are reported here.

### Low bearing zone

The reference track is an existing double track section of the French National rail network within the Alps. Costly maintenance activities and repeated track leveling needed to be undertaken due to sub-soil problems.

A previous renewal of the superstructure did not have the expected effects, and the problem remained. It was then decided that subsoil improvements should be carried out to solve the problems encountered on the site. Site investigation resulted in special drainage construction that resolved the problem. The LCC evaluation of the solution demonstrated that without the implemented innovative solution the cost over the life cycle of 40 years would be more than double mainly due to the annual maintenance costs.

### Soil strengthening under existing railway embankment

In this case, the innovative solution consisted of soil strengthening of the embankment with inclined lime cement columns. To carry out a full LCC calculation of the economical benefits would require a comparison with a reference system. However, such a reference system could not be defined, partly since the need for strengthening stemmed from the need to upgrade the

axle load of the line: Such an upgrade would not be possible on the existing track, which therefore could not act as a reference system.

Compared with an earlier project done with vertical lime cement columns underneath the track, the following figures were derived: For the innovative system costs for investigations and design were 21% and the installation of the lime cement columns 16% of the total costs. A traditional reinforcement with only vertical lime cement columns would have carried additional costs of 56% due to the excavation of the track. In addition, the innovative solutions required no closure of the track, which also had a significant effect in reducing costs for delays etc.

### Transition zone

The optimised solution consisted of the improvement of 32 meters of an embankment at both sides of a concrete block. The improvement consisted in replacing 2.5 meters of the material under the sleeper with well-compacted sandy gravel of QS3 type. The gravel was reinforced with two layers of geo-grid. Further, a 35 cm thick layer of high-quality ballast replaced the ballast at both sides and on top of the concrete block.

An LCC evaluation needs to account for investment and maintenance. For the reference system (previously existing track) only the cost due to speed limitations could be taken into account as non-availability cost. With the optimal solution speed restrictions can be lifted and the maintenance costs decreased significantly. The benefit of the optimised system was evident since the investment was small compared to the maintenance costs of the reference system over the studied period.

### Innovative slab track form – Balfour Beatty Embedded Slab Track

In INNOTRACK also alternative track support systems have been studied. These solutions aim at meeting new demands like increasing speeds and axle loads. One such solution, the Balfour Beatty Embedded Rail System (BB ERS), has been evaluated with respect to LCC. The BB ERS was based on an existing concept that was modified to obtain lower manufacturing and installation costs. The reference system towards which LCC savings are assessed is a standard ballasted track with a service life of 40 years, CEN60 rail and concrete sleepers.

Analysis has shown that a significant reduction in LCC is potentially possible with the BB ERS slab track system, but that the benefits are dependent on the annual tonnage and discount rate.

Comparing the total costs over 60 years per track metre (without consideration of the discount rate), there is a saving with BB ERS over ballasted track of 20–30% for all annual tonnages modelled. This is due to lower maintenance requirements and a longer service life for the BB ERS solution. It should be noted that this example includes the costs for the BB ERS associated with making soil improvements prior to installation of the concrete slabs.

## 9.2 Savings on switches and crossings (S&C)

### LCC input data – base case

Input for the S&C LCC model is based on statistics from Banverket, DB and SNCF. These figures are approximate as they represent a combination of experience from

several countries and track conditions. The data shown in Table 9.2-1 represents the base case for S&C, i.e. no innovative solutions implemented.

LCC-Input	Value	Post-repeat loading	Source
<b>General data</b>			
Traffic data	20	Million Gross Tonnes (MGT)/year	1
Technical Life Time	500	MGT (25years)	2
<b>Maintenance activities</b>			
Failure rate	1.5	failure/year	1
Preventive maintenance	20	maintenance actions/year	1
Mean time to repair (MTTR) for corrective maintenance	0.5	Hours	1
Mean time to repair (MTTR) for preventive maintenance	1	Hours	1
Mean waiting time (MWT) for corrective maintenance	1	Hours	1
Mean logistic delay time (MLDT) for preventive maintenance	1	Hours	1
Replacement of crossing	240	MGT	3
Replacement of switch blades	160	MGT	3
Tamping interval	120	MGT	3
Grinding interval	80	MGT	3
<b>Unavailability data</b>			
Probability for train stop	33%	per failure	1
Train delay cost	80	€/min	1
<b>Cost data</b>			
Investment material cost	125 000	€	1
Investment installation cost	35 000	€	1
Investment material cost	50 000	€/h	
<b>Net present calculation</b>			
Discount rate	5	%	1
Calculation period	25	Years (See TLT above)	

Table 9.2-1: S&C LCC input data (base case – no innovative solutions implemented). Sources: 1) Agreed within SP3; 2) Literature: (Zwanenburg 2008); 3) Swedish data

Infrastructure	Investment	TLT	Corrective maintenance	Train delays	Preventive maintenance	Operation	Inspection
Design and material	6%	20%	-30%	-30%	-30%	-	0%
Driving and locking device	9%	0%	-80% <sup>1</sup>	-80% <sup>1</sup>	-60% <sup>1</sup>	-	0%
Condition monitoring	4%	20%	-20%	-50%	+20% <sup>2</sup> -15% <sup>3</sup>	+0.3k€/year	-49%

Table 9.2-2: Changes to LCC input data (base case) for each innovative solution from INNTRACK. Comments: 1) Only control device and switch device; 2) small activity maintenance (adjustment and small repair); 3) larger repair and replacements.

### LCC input data – innovations

Using data in Table 9.2-1, LCC models have been built for three different cases:

- Design and material
- Driving and locking device (DLG)
- Condition monitoring

For modelling the three cases the assumptions in Table 9.2-2 have been proposed.

### Justification employed values in Table 9.2-3

Material improvements and developments of new designs are evaluated in the INNTRACK demonstrator project. The results of these full-scale field tests will be presented in 2011 and 2012. Therefore only preliminary data can be used for assessment at this point.

Regarding design and material predicted reductions in deterioration have been quantified in deliverables D3.1.5 and D3.1.6. In the LCC calculations a reduction of 30% in frequency of maintenance and an increased

technical lifetime have been assumed based on these predictions.

For driving and locking devices, the adopted figures are based on the investigations in deliverable D3.2.1. For condition monitoring deliverable D3.3.6 has been used as a basis for the values.

LCC outputs using the INNTRACK LCC model with the changes to input data shown in Table 9.2-2 applied to a single S&C unit shows that the potential reduction in LCC due to each S&C innovation is as shown in Table 9.2-3.

All values refer to total LCC of a S&C, and since some of the LCC benefits overlap, the total savings of 24.0% is not an exact sum of the individual results. Further indirect savings are expected due to better logistics and service planning. For example, 1 hour of net service time on track may take a total of 5 hours when travelling and waiting times are included.

Innovation	Reduction in LCC value compared to base case
Design and material	10.2%
Driving and locking device	11.7%
Condition monitoring	4.2%
<b>TOTAL</b>	<b>24.0%</b>

Table 9.2-3: Summary of LCC reduction through implementation of INNTRACK innovations regarding switches and crossings.



## 9.3 Approach to assess rail related cost savings

A model for rail LCC has been developed (using the principles defined by INOTRACK). This model combines the effects and inter-dependencies of:

- Rail grade selection
- Rail grinding
- Gauge face rail lubrication

Two pieces of analysis have been carried out using this tool.

Firstly, the whole life costs for 220 individual curves (~400 track km) on three main line routes in the UK have been analysed, investigating the impact of different combinations of rail steel, lubrication and rail grinding frequency on the LCC for different curve radii. For this case, the rail degradation rates (for rolling contact fatigue and rail wear) are modelled using Network Rail's TrackEx software which generates curve-specific predictions based on actual traffic data (frequency, vehicle type, line speed) and track data (measured lateral geometry, rail grade). The TrackEx tool utilises rolling contact fatigue (RCF) and rail wear damage accumulation theories based upon contact patch energy (the combination of creepages and creep forces), which have been developed and tested in the UK principally since 2001. The approach is the subject of ongoing validation but has been calibrated against major RCF studies on three NR routes and is accepted by the UK rail industry as an important tool in understanding how best to control RCF.

Secondly, the LCC for all curves <2500 meter radius in the UK has been examined, using average modelled rail degradation rates and the rail degradation algorithms created in INNOTRACK.

### Route-specific LCC

The input parameters and key assumptions used to conduct the route-specific analysis for rail LCC are as follows:

- Grade 370CRHT rail has been chosen as the premium steel grade to be modelled, as this has been on trial in the UK since 2007 and an initial relationship between wheel/rail contact energy and RCF damage has been developed for this grade based on known material properties and in-service performance to-date.
- Lubrication is assumed to reduce the rate of side wear by a factor of 4 (similar to what has been reported in Sweden and elsewhere).
- Network Rail's 2009/10 standard unit costs for installation, maintenance and inspection have been applied.
  - o The material cost of the premium rail grade is 40% higher than the standard cost of Grade 260 rail.
  - o Rail grinding unit costs are based on the slow timetabled train mode of operation, i.e. minimum cost per metre.
  - o The fixed cost for installation of an electric track lubricator includes equipment and possession costs. One track lubricator per 500m of track is specified.
  - o Ultrasonic inspection costs/track km for both train-based and manual inspections are included.
- Current Network Rail standards for the frequency of different inspection techniques have been applied – these are based on the line speed and annual traffic tonnage carried by each section of track. Additional inspection requirements for RCF sites are also included in the cost analysis.
- Traffic levels are held constant through the 40 year period of analysis, for each curve modelled. However, traffic levels (both frequency and type of vehicle) can vary significantly from one curve to another and these differences are accurately included by using the actual monthly

recorded traffic from July 2009 for each curve (as recorded in Network Rail's ACTRAFF database).

- A discount rate of 6.5% has been applied in net present value (NPV) calculations.
- Rail replacement occurs when RCF surface crack length reaches 20mm.
- Rail replacement occurs when side wear reaches 9mm or vertical wear exceeds a value equal to (14 – current side wear value).
- Rail grinding removes 0.2mm of metal from the vertical rail axis and 0.3mm of material from the gauge corner but does not increase the rail side wear at the measurement position.
- Rail grinding has two effects on RCF:
  - o Reduces surface crack length by 1.2mm (assuming cracks propagate into the rail head at 30° to the rail running surface and that RCF cracks are approximately semi-circular throughout propagation).
  - o Offloads existing RCF cracks by creating gauge corner profile relief. This relief must be worn away before cracks are allowed to propagate again. The relief is worn away at a rate directly proportional to the modelled rail vertical and side wear.
- The LCC analysis has been carried out for high rail wear and RCF and excludes any consideration of low rail damage, for which premium rail has already demonstrated LCC benefits during UK trials.

The first case study looked at Mainline 1 route with known problems of severe RCF. 39 km of the 158 km of track modelled has a curvature of less than 4000 meters; 11 km is less than 1400 meters in radius. Typical traffic tonnage on the lines included in the analysis is 10 to 30 MGT/year, made up primarily of passenger rolling stock. A majority of the rolling stock has stiffer suspension characteristics (primary yaw stiffness) known to contribute to increased wheel-rail lateral contact forces and RCF initiation/propagation rates.

LCC analysis for Mainline 1 has shown that the combination of premium rail and a modified standard rail grinding frequency could reduce total LCC for all of the curves modelled by up to 16%.

The second Mainline 2 track included in this analysis has a smaller proportion of tighter radius curves than Mainline 1 (28 km of the 129 km of track modelled has a curvature of less than 4000 meters but only 1 km is less than 1400 meters in radius). Approximately 10% of the annual traffic is freight; a high proportion of the passenger coaching stock on the route is known to be relatively damaging in terms of RCF for tighter radius curves.

Repeating the analysis shown above indicates that the LCC offered by premium rail combined with grinding is slightly higher (by less than 2%) than the case with Grade 260 rail. Reviewing the detailed calculations for Mainline 2 shows the LCC model predicts that using Grade 260 rail with grinding at every 15MGT results in RCF-free high rails on each of the curves included in this analysis. This is partly due to the low modelled vertical/side wear rates for each curve which results in the ground gauge corner profile relief (and subsequent off-loading of RCF cracks) being maintained for the full period between grinding operations.

The final Mainline 3 track included in this analysis has a range of curve radii between the first two cases modelled – 45 km of the 132 km of track modelled has a curvature of less than 4000 meters and 7 km is less than 1400 meters in radius. 95% of the annual traffic is passenger rolling stock, the majority of which is high-speed intercity trains with relatively high bogey suspension characteristics.

For Mainline 3, a combination of premium rail steel and rail grinding at extended frequencies does result in a reduction in LCC reductions compared to using Grade 260 rail with rail grinding and lubrication.

Curve radius less than 1000 meters: installing premium rail steel and grinding every 15 MGT reduces LCC by more than 70%.

Curve radius 1000 meters to 2600 meters: a combination of premium rail and rail grinding every 45 MGT results in the lowest LCC, reduced by approximately 4% from the reference case.

The analysis for Mainline 2 and 3 route sections highlights how, for marginal LCC cases, the discounting rate applied has a significant effect on the results. For example, without discounting the LCC reduction for Mainline 3 curves 1000-2600m radius is more than 20%, compared to 4% with discounting. Alternatively, the analysis indicates that if the initial cost of premium rail grades can be reduced through development of alternative rail metallurgies and manufacturing processes, the economic case for the use of premium rail in curves with higher side wear and rolling contact fatigue crack growth rates is further strengthened.

#### Full network analysis

The use of premium rail, rail grinding and rail lubrication is likely to have the greatest impact on LCC for the primary route curves of less than 2500-meter radius, which equates to around 8% of the Network Rail network. There will be benefits for some more highly utilised secondary and tertiary routes. These have not been included in this

analysis as the issues are site-specific, so a high-level, generic LCC analysis is not appropriate.

When looking at LCC result for the full network two scenarios have been modelled for all Network Rail primary curves with less than 2500 meter radius: Scenario 1: Grade 260 rail, grinding every 15 MGT and lubrication on curves with less than 800-meter radius; Scenario 2: Premium rail, grinding every 15 MGT up to 1500-meter radius and 45 MGT for curves 1500 to 2500 meter radius. No lubrication.

Tables 9.3-1 and 9.3-2 summarise the results from the LCC calculations for both scenarios. Table 9.3-1 results are based on the use of *average* modelled rail degradation rates. Table 9.3-2 shows data using *maximum* modelled degradation rates. Note, the two sources of rail degradation rates used in the full network analysis produce predicted overall LCC reductions within a similar range. The INNOTRACK degradation algorithms produce LCC reductions at the higher end of the ranges shown in Tables 9.3-1 and 9.3-2.

The analysis highlights that in some cases premium rail, while extending rail life, may not reduce LCC. For example, as curve radius increases (1500 to 2500 me-

ter category), the measured and modelled degradation rates for both Grade 260 and premium rail are low. For this reason, the LCC of Grade 260 rail may, for some curves, be lower than the case when premium rail is installed. This illustrates that rail grade selection should be based on a knowledge of rail degradation rates at specific track sections rather than simply track curvature and traffic tonnage (which are two important, although not the only, variables).

A total LCC reduction of 11% to 30% is predicted for the use of premium rail (discounted over 40 years), or 27%–54% if values are converted to 2009/10 prices.

The results above (at 2009/10 prices) have been converted to an assessment of the potential reduction in annual track costs as follows:

- The annual track maintenance and renewal budget is split approximately 46% for renewal and 54% for maintenance (including inspection).

- Rail-only costs for curves <2500m radius are approximately 4.8% of the annual track budget – this is made up of costs for rail-only replacement in curves, inspection, rail grinding and rail lubrication plus a proportion of indirect costs.

Applying the potential LCC reduction of 27% to 54% at 2009/10 prices to the 4.8% of annual rail-only related costs results in an annual reduction in the total Network Rail track maintenance and renewal budget of 1.3% to 2.6%, see Figure 9.3-1.

This reduction in the annual budget is the 'steady state' position once premium rail has been installed on all Primary route curves of <2500m radius and represents a significant annual cost saving for NR.

Curve Radius (m)	Scenario 1	Scenario 2	Reduction in LCC for Scenario 2
	LCC £k/Track km	LCC £k/Track km	%
<800	342	276	19
800–1500	229	176	23
1500–2500	165	174	-6

Table 9.3-1: LCC reduction for Scenario 2 compared to Scenario 1 – based on average modelled rail degradation rates.

Curve Radius (m)	Scenario 1	Scenario 2	Reduction in LCC for Scenario 2
	LCC £k/Track km	LCC £k/Track km	%
<800	576	416	28
800–1500	296	177	40
1500–2500	223	175	21

Table 9.3-2: LCC reduction for Scenario 2 compared to Scenario 1 – based on maximum modelled rail degradation rates.

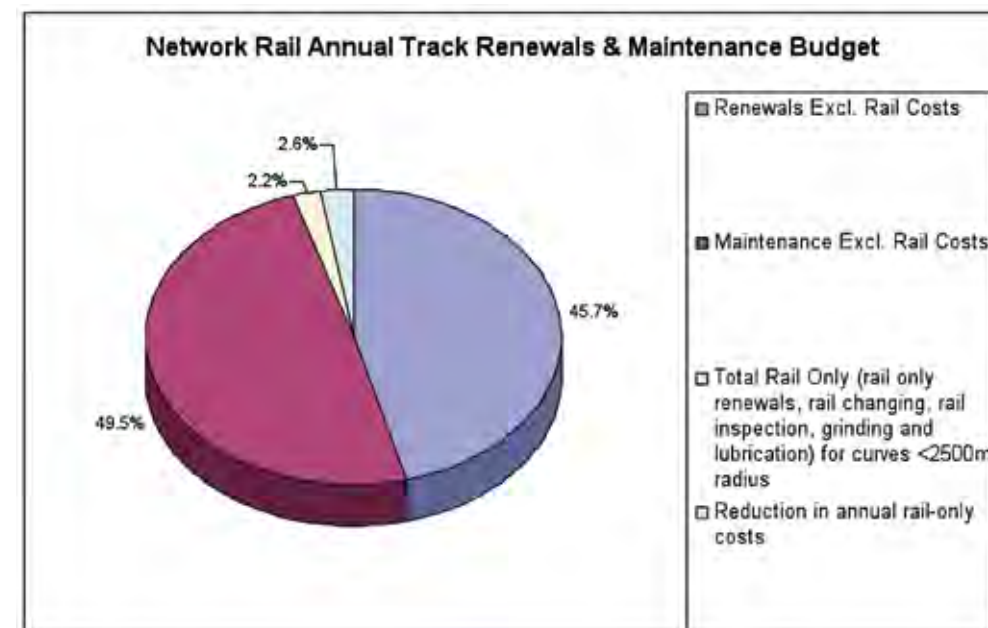

Figure 9.3-1: Maximum potential reduction in the total Network Rail annual track budget if premium rail steel is combined with a modified rail grinding strategy on all Primary route curve of < 2500m radius.

## 9.4 Conclusions from “Overall Cost Reduction”

The predicted cost savings from innovations can be estimated in two different ways namely;

- Life cycle cost calculation;
- Comparison of future operation costs with and without innovation.

The results from the different calculations could also lead to different conclusions being made and hence the background and reasons behind the calculations must be known.

The life cycle cost calculation favours low investment costs due to the discounting factor.

Poor understanding and definition of infrastructure costs makes it very difficult to determine the existing costs and hence the base case to compare with innovations. LCC calculations for a number of key innovations developed by the INNOTRACK indicate significant reductions in the net present value (NPV) LCC compared to the base cases are achievable for specific sites/route sections:

- Subgrade improvement (drainage) – 60% reduction for the case analysed;
- BB ERS slab track – 20% reduction for annual traffic of 55 MGT with potential for greater reductions at higher annual tonnages;
- New s&c designs, materials, components and monitoring – 20% reduction;
- Premium rail and rail grinding – maximum 30% reduction for the sites modelled.

Some innovations lead to savings, which are difficult to quantify. For example transition zone optimisation investments or soil strengthening by inclined piling are compared to savings of increased speed/reduced delay. It is difficult to estimate the number of sites across a network which

could benefit from this modification and hence the future savings. In addition there are at least three categories of innovations that are inherently difficult (if not impossible) to assess in terms of LCC benefits.

The first category is innovative procedures for cost-efficient and more reliable means of preventing events that in rare occasions may carry extremely high costs. The work on rail breaks in INNOTRACK is a typical example of this category. The second category is innovations where legal demands set the boundary conditions. The work on corrugation and its relation to noise pollution in INNOTRACK falls under this category: The increased knowledge promotes better planning of maintenance, better credibility towards legislative authorities, and reduces the risk of punitive actions. However, to put exact figures on related cost savings is very cumbersome. The third category is where the innovative solutions provide a better basis for decisions. The work in INNOTRACK on geo-physical methods may serve as an illustrative example: A better knowledge of the subsoil conditions allows for better targeted strengthening actions. However it is very difficult to rate the benefits precisely.

The work carried out in INNOTRACK on overall cost reduction has shown the difficulty with scaling up life cycle costs to whole networks using generic rules for LCC calculations. Instead, a comprehensive ‘bottom-up’ approach is recommended where every site that can potentially benefit from use of innovative technology is analysed separately and the results from individual analyses can be summed to calculate the total network-wide LCC reduction. However, as mentioned above, such an approach can only theoretically give the total LCC for an entire network due to

the size of the task and data needed. It can here be noted that to properly assess the LCC benefits from INNOTRACK all LCC savings related to all implementable results listed in appendix VI in this Concluding Technical Report need to be accounted for.

The true LCC benefits of a number of the innovations developed by INNOTRACK will only emerge after several years of site trials. As well as closely monitoring the technical performance of new technology, it is recommended that a comprehensive record of interventions and costs is maintained for trial sites so that the economic impact of the innovations can be properly assessed.

### References

1. INNOTRACK Deliverable D1.4.8, Overall cost reduction, 34 pp (and 1 annex 3 pp), 2009
2. INNOTRACK Deliverable D3.1.5, Recommendation of, and scientific basis for, optimisation of switches & crossings – part 1, 30 pp (and 3 annexes, 12+12 pp), 2009
3. INNOTRACK Deliverable D3.1.6, Recommendation of, and scientific basis for, optimisation of switches & crossings – part 2, 20 pp (and 3 annexes 10+14+16 pp), 2009
4. INNOTRACK Deliverable D3.2.1, Definition of acceptable RAMS and LCC for DLDs, 24 pp (and 1 annex, 4 pp), 2008 [confidential]
5. INNOTRACK Deliverable D3.3.6, Quantification of benefit available from switch and crossing monitoring, 21 pp, 2009

# DISSEMINATION AND IMPLEMENTATION OF RESULTS 10

# DISSEMINATION AND IMPLEMENTATION

Björn Paulsson, UIC. Michael Bayley, UNIFE and Anders Ekberg, Chalmers

Larger research and development (R&D) projects are limited in duration. They have a start date and an end date (see Figure 10-1). After the end of the project, the project organization is disbanded and the involved persons move on to other tasks. For this and other reasons, too many R&D projects create good results that are not implemented in everyday operations. Instead of being used, final reports end up as “shelf warmers”. To avoid this in INNOTRACK, a multitude of activities have been carried out in a planned and target oriented way. In addition, resources for implementation have been allocated in advance. The purpose has been to ensure that the implementation of INNOTRACK results becomes a natural continuation of the project.

The fact that the railway community is very complex with different target audiences complicates the dissemination process. As a starting point, in INNOTRACK the target audiences have been identified. Furthermore, necessary mediums of communication for these groups have been identified and information material produced. To further enhance the communication with the railway sector, several organizations outside the INNOTRACK consortium have been active during the entire course of the INNOTRACK project.



Figure 10-1: INNOTRACK is a project with a start point and an end point.

A rapid implementation of the innovations developed in research projects is generally difficult. The conservatism in the railway sector (for which there are of course also good reasons) adds to this. One way to enhance the adoption of innovation that has been reported in INNOTRACK is that most solutions have been developed in cooperation between the industry, IM's and universities/institutes. This fosters a broad awareness, knowledge and trust in developed solutions.

Another demand to make the results useable is that it must be easy to find background documents. This question has been dealt with during the entire project. A good example for how it has been tackled is this book where you can find a lot of references to reports, which makes them easier to find. A second example is the knowledge management system and the INNOTRACK website ([www.innotrack.eu](http://www.innotrack.eu)) from where public INNOTRACK reports can be downloaded.

Last but not least there have been a number of databases created in INNOTRACK. They will be maintained at the UIC where a dedicated project has been assigned to this end.

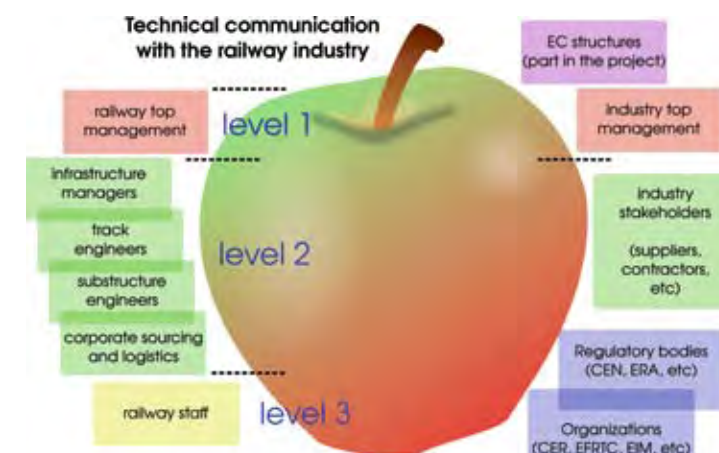

Figure 10-2: Target audiences identified in INNOTRACK

## Dissemination and training

In INNOTRACK the target audiences have been identified. See Figure 10-2. These different target audiences have been addressed in different ways depending on their needs.

The different means of dissemination that have been employed for the target audiences are described in detail in deliverable D7.1.6.

The EU-structures have been addressed mainly through the European Commission represented by the project officer. His role has been to ensure that INNOTRACK was performing according to contractual agreements. This has worked well and has been straightforward since it is clearly regulated.

At three occasions whole day presentations have taken place. All parts of INNOTRACK have been presented and discussed. In order to make the presentation and discussion more fruitful, deliverables have been sent to the European Commission in advance. The major parts of the discussions have dealt with the produced deliverables.

Infrastructure managers (IM's) have been addressed in different manners depending on their interest in INNOTRACK.

The top managers of the railways and the industries have been, and will be served information in two ways: Firstly there has

been continuous information exchange with the European IM's during the project. This information has concerned the overall status and also detailed information on specific topics. This information exchange has been carried out e.g. via the UIC infrastructure forum. Secondly, a pamphlet and a video that will summarize INNOTRACK are being produced along with a top management summary report. The objective is to inform on how INNOTRACK has achieved its objectives and which effects the innovations from INNOTRACK will have.

Infrastructure managers at a high technical level constitute a non-homogeneous group. The media of communication of INNOTRACK results for this group is mainly this concluding technical report. During the project, this group has been further addressed in different ways. Examples are presentations at the UIC track expert group and at the UIC panel of structural experts. Further, there have been a number of direct visits to the IM's

Railway engineers, experts on track and structure constitute a more homogeneous group and are easier to identify in the different IM's. The media of communication for this group is mainly the INNOTRACK deliverables, the guidelines and this concluding technical report, but also presentations at workshops, seminars and conferences.

They are the most important target audience for this book and for the rest of the material produced in INNOTRACK.

Railway staff working with corporate sourcing & logistics has not been easy to identify and find in the different railways' organisations. To inform this group and implement INNOTRACK results, other organisations like EIM (the European rail infrastructure managers), CER (the community of European railway and infrastructure companies) and EFRTC (European federation of railway trackworks contractors) has provided support and formed working groups. More information on these initiatives is available in deliverable D5.2.I.

Furthermore, in order to make INNOTRACK known to purchasing units of the different IM's, information has been given to the European railways purchasing conference (ERPC) at two occasions.

Railway staff on an operational level has mainly been addressed through the training centres and through national track experts. Since the level of English is often low for this category, translation of key INNOTRACK reports and results is important. An example of this is translation of some guidelines into German and French.

In order to facilitate implementation at the IM's and industry, special meetings have been and will be arranged with the IM's and the industry in INNOTRACK at their "home ground". The purpose was and is to give an overview of the entire project, to increase the knowledge on how to find appropriate information and to spread a better understanding of how the implementation of results from INNOTRACK can be supported. In this context one must be aware that a lot of track experts within the IM's have a very clear opinion and are sometimes doubtful of new R&D findings. Especially when INNOTRACK states that savings in the order of 30% are possible in the area that is covered by INNOTRACK. Therefore face-to-face meetings are important to be able to explain the

background for the INNOTRACK claims and provide a dialogue.

Top management in industry will be addressed via the top management information material (the same documents intended for the top management among IM's). Publications will also be delivered to top management directly via the UNIFE high-level committees (UNIRAILINFRA – UNIFE's strategic/business infrastructure committee, the Strategy committee, and the Presiding board). The top management summary report will be available at UNIFE's offices and at association events.

The main media of dissemination to rail and component suppliers and contractors will be this concluding technical report, the top management summary report and the INNOTRACK guidelines, depending on the level – management or operational.

Organizations & regulatory bodies constitute an important and often forgotten group in many EU-projects. INNOTRACK has been active in approaching these bodies:

CEN (the European committee for standardisation) is an important player in Europe to produce standards. They have their technical committee no 256 for railway applications. INNOTRACK has already supplied CEN with base material for the standardization of hollow sleepers. More material is in the process of being supplied as it reaches a suitable level of maturity.

CER, EIM and EFRTC have taken over some parts of the INNOTRACK subproject on logistics in a positive way. The issues they have taken responsibility for need to be solved through long-term collaborative work between contractors and IM's. Since INNOTRACK is a time-limited project, it was realised that it was not possible to conclude this work in INNOTRACK. The initiative from CER and EIM to conclude the work was therefore most welcome. See more in D5.2.I.

Special concern has been taken to reach the geotechnical experts in the railways. Since most railways have very few such experts they are often not easy to find in the

organisations. To this end, INNOTRACK has informed ELGIP (European large geo-engineering institutes platform) on the progress of INNOTRACK in general and in the field of geo-engineering in particular.

### Implementation

Implementation of results is, as mentioned above, an Achilles heel of most EU-projects. Therefore much effort has been spent to make the result from INNOTRACK easier to implement. One specific action discussed above is that the media of dissemination have been tailored to the target audiences. In Figure 10-3 you can see how the docu-

to this end. The guidelines should further contain clear recommendations. There are different types of guidelines produced in INNOTRACK. Some take the form of annotated checklists, others are descriptions of functional requirements and some give background for, and recommendations of operational regulations. Many of the guidelines will be translated into German and French since the target audiences are not generally accustomed to English.

In INNOTRACK seven databases have been produced. Five of these will be maintained and used in the future. The remaining two databases represent "snapshots" of operational data and will be saved but not maintained.

This book, the Concluding Technical Report, is in many ways the "key" too reach INNOTRACK results. It is intended to provide a compact overview of the results of INNOTRACK. It is not part of the contractual agreement with the European commission, but a document that the INNOTRACK coordination group during the course of the project understood was necessary to aid in the implementation of the derived results.

The top management report for IM's and industries is extracted from the first chapter – the summary – of this book. This executive summary will be accompanied by a pamphlet and a video.

To further promote dissemination and implementation, several activities were decided at the last INNOTRACK steering committee meeting and detailed in a dissemination concept. Examples of planned activities include maintenance of the INNOTRACK website and reports, LCC dissemination- and working groups. In addition a continuing cooperation between the members of the steering committee and the coordination group after the official end of INNOTRACK has been agreed. Further, bilateral agreements are established for joint

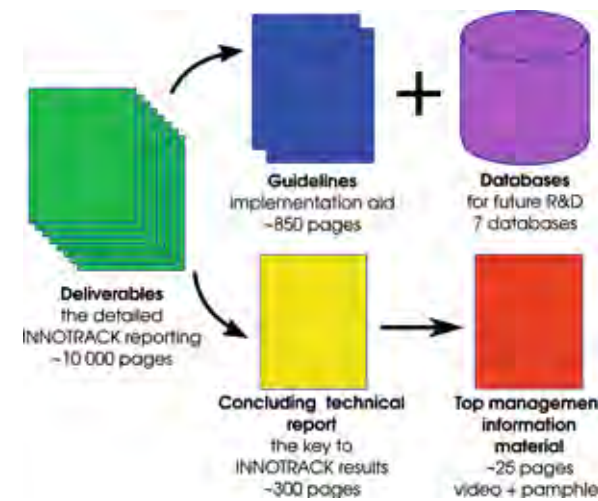

Figure 10-3: Linking of the INNOTRACK documentation

mentation in INNOTRACK is linked together. The deliverables are technical and present the results of INNOTRACK. They are aimed at reflecting the stated achievements in the INNOTRACK description of work in a thorough, stringent and complete manner. They are delivered to the European Commission in order to fulfil the contractual obligations. At the same time they represent the complete results of the INNOTRACK project.

To facilitate implementation, guidelines are needed. These focus on practical application and implementation issues. Clarity and straightforwardness are key concepts

implementation efforts. An example is the cooperation between DB and BV to further develop and test the INNOTRACK switch.

#### **Important presentations of INNOTRACK**

On seven occasions, major kick-off meetings, general assemblies, workshops and seminars have been arranged by INNOTRACK. During all occasions, a wider audience than merely the INNOTRACK partners has been invited. The main reason is that throughout the project there has been an ambition to have a wide dialogue not only with the participating organisations but also with the whole railway society. Since the project is both political and technical, two kick-off meetings were held in the beginning of the project. The “political” kick-off was on the 21st of September 2006 in Berlin and the “technical” kick-off on the 5th and 6th of October 2006 in Paris.

Combined general assemblies and workshops were held in 2007 and in 2008. On these occasions the current progress of the project has been presented both from a technically and from a management point of view.

At the end of the project two technical seminars were held. The first focused on rails and switches & crossings and was held in Brussels on the 14th of October 2009. The next day (the 15th of October) a workshop focusing on substructure was held in Paris.

Finally on the 19th of January 2010 a combined general assembly and workshop, which focused on asset management, economical impact, cost drivers, LCC, RAMS and logistics was held in Paris.

#### **Important conferences and publications**

Presentations on INNOTRACK have been given at the following important conferences:

- World congress on railway research (WCRR) in Montreal (2006) and in Seoul (2008).
- Contact mechanics and wear of rail/wheel systems (CM) in Queensland (2006) and in Florence (2009).

- International heavy haul conference (IHHA) in Kiruna (2007) and in Shanghai (2009). The overall presentation on INNOTRACK results given in Shanghai has been accepted for a special issue of the Journal of Rail and Rapid Transit.

- InnoTrans 2008 in Berlin.

#### **Infrastructure Managers events**

UIC Infrastructure Forum is an event that is held twice a year. At all meetings since and including 2006 INNOTRACK has been presented.

#### **Industry events**

INNOTRACK was separately presented at InnoTrans 2008 in Berlin at the joint UNIFE-UIC research stand. The event coincided with the release of a project mid-term newsletter and renewed flyer. INNOTRACK will also be presented at the InnoTrans 2010 event in Berlin.

#### **Lessons learnt concerning dissemination and implementation**

The most important lessons learnt from the INNOTRACK project is that a three-year project is far too short if you have an ambition to really implement results within the project. There are two important factors that influence this. The first is that the IM's are (and shall be) slimmed organisations. The second is that regulations that the IM's don't have influence over can result in very slow processes. An example was the acceptance of track tests in INNOTRACK, where the approval process delayed the project considerably.

Another important lesson learnt in this area is that even excellent solutions need several years to go from idea to product. Add to this that very few ideas are complete in all details when the development starts.

Despite these two important lessons that have been learnt, INNOTRACK has been a major leverage in implementation. This is mainly due to the fact that most solu-

tions have been developed in cooperation between the industry, IM's and universities/institutes. This creates further trust in the solutions and recommendations and thus speeds up the implementation process.

#### **Reviewing and quality assurance**

Reviewing of deliverables produced in INNOTRACK has been a key element in the quality assurance of the project. It has further paved the way for operational implementation. The key concepts for the INNOTRACK review process have been:

- Ensure a sound scientific basis
- Ensure “implementability”
- Pave the way for implementation
- Assure a high quality
- Ensure traceability of corrections and validations
- Enforce a streamlined process with limited efforts for the participating persons

In short reviewing has been carried out at three levels:

1. Internal reviewing during the drafting of the deliverable report
2. Internal reviewing by an independent project partner
3. External reviewing

All deliverables have been subjected to the first level of reviewing. All except a handful has been subjected to the second level of reviewing. Regarding external reviewing 45 deliverables have been subjected to reviewing of railway experts (resulting in 123 review reports), 25 deliverables have been subjected to scientific reviewing (resulting in 25 review reports), and 7 deliverables have been subjected to reviewing from industry experts (resulting in 7 review reports).

Independent reviewing of the INNOTRACK deliverables was not detailed in the contract with the European commission. However, it was recognized at an early stage that in order to ensure railway relevance and a high quality of the deliverables,

independent reviewing would be needed. Furthermore it was realized that reviewing by experts outside the INNOTRACK consortium would have the benefits of broadening both the expert base scrutinizing reports at an early stage and increase the potential for future implementation.

In summary, a key success factor in the review process has been the solid participation from the railway community. By the strong engagement from UIC, UNIFE and the scientific community it has been possible to get a broad and very competent scrutiny of the INNOTRACK deliverables.

The major complication originates from the fact that high-quality (independent internal and external) reviewing takes time. If this is not understood, the project runs the risk of being considered as delayed due to an additional quality assurance work.

In summary it can be stated that the extensive reviewing carried out makes INNOTRACK a unique European research project in the railway sector. This is not only due to the massive amount of external reviews (more than 150 review reports), but also due to review from the perspectives of infrastructure managers, the railway industry and the scientific community. The estimated value of the review efforts is over 100 k€. This is considered as resources well spent since the effects of the reviewing is not limited to increasing the relevance and quality of the deliverables. Other effects include raising the level of awareness and knowledge all over Europe and paving the way for implementation. This benefit was understood by the railway experts who largely did complimentary review work.

#### **Activities after 2009**

Five training courses focusing on assisting with the implementation of the results from INNOTRACK are proposed for 2010. They are to be arranged by the UIC and concern

- Subgrade improvements
- Recommendations on switches & crossings
- Rail grade selection

- Minimum action rules and maintenance limits
- Life cycle cost (LCC) calculations

For each course at least two railways are responsible for the organization. On the meetings with IM's and industry more areas have been proposed.

Finally it should be noted that the UIC-track expert group (TEG) is going to have a key role in how the INNTRACK results will eventually be implemented on a European level. It should here be noted that the UIC-TEG has been heavily involved in the reviewing of INNTRACK deliverables and thus are well prepared to implement the results. This has already resulted in some UIC leaflets being proposed for update based on to the results from INNTRACK.

#### References

1. INNTRACK Deliverable D5.2.1, Documented validation procedure, 20 pp, 2009
2. INNTRACK Deliverable D7.1.6, Summary of dissemination and training – lessons learnt, 24 pp, 2009

# CONCLUDING REMARKS 11



# CONCLUDING REMARKS

## Results achieved and overall pros and cons

In a major project like INNOTRACK there are always things that have gone well and things that have gone less well. This section provides a summary of the key results from each sub-project. It should also be emphasized that the magnitude and types of outcome reflect the different conditions prevailing in the various sub-project areas.

As an example, significant research and development has been carried out during the last ten years in the field of rails and welding, which is the scope of subproject SP4. Consequently, a lot of directly useful guidelines were possible to produce in this sub-project. In the sub-project on switches and crossings (SP3) the current state-of-the-art required more basic research and development to be carried out, which has resulted in some very promising results. In the sub-project on LCC and RAMS (SP6), the current use was found to be in its infancy, mainly due to lack of useful input data. Consequently, the work carried out had to be modified from that planned originally.

## Duty (SP1)

### Pros

- For the first time national workshops were carried out from an international perspective and were adjudged successful and very useful. Furthermore, an important conclusion was that the key cost drivers identified in the national workshops were indeed internationally relevant problems. The differences between the key national cost drivers in different countries were less than expected.
- The investigations about problem conditions have also been a success. The work on cost drivers and the related root causes and innovative solutions to address the problem was a significant step forward. Finally the derived tools

and databases were also notable achievements.

### Cons

- Collecting accurate and useful data has been a problem primarily because of the lack of good quality data at the different IM's.
- The idea of using general segmentation was only a partial success again because of the lack of reliable data on maintenance activities and costs that could be correlated with observed degradation of track.
- Also the review process used to verify innovative solutions turned out to be too complex for the large number of deliverables produced in INNOTRACK.

## Track support structure (SP2)

### Pros

This was the first time a broad European project in this area has been carried out. INNOTRACK has opened a wider European view in this previously very national area. Different measuring and strengthening methods have been compared and evaluated. This will be valuable knowledge for the future.

Several results have also been implemented within INNOTRACK such as:

- reinforcement of a soft embankment area with inclined lime cement columns
- improvement of transition zone using geo-synthetics
- improvement of a bad drainage zone
- test section of Corus two layer steel slab track.

### Cons

The test section of the BBEST slab track was not possible to produce within the project due to the limited time frame and circumstances outside of INNOTRACK's control.

## Switches and crossings (SP3)

### Pros

A real step forward has been taken on how to reduce the dynamic loading in switches, regarding both lateral and vertical forces. This has been through an evaluation of the influence of, and subsequently to the optimization of track gauge and stiffness.

An optimized frog geometry has been developed. This geometry has also been verified by simulations and in full-scale tests.

A new generation of hydraulic actuators were developed and demonstrated in the project. Both solutions are mounted in hollow sleepers, which standardisation within INNOTRACK has been recommended as an EC-norm.

An open standard for an ethernet-based communication between signalling plant and switch has been developed.

New algorithms for switch monitoring have also been developed.

### Cons

A 3–4 year project is too short to undertake demonstrations of developed solutions and evaluate performance to propose optimised solutions.

## Rails and welding (SP4)

### Pros

Several guidelines that represent significant steps forward have been issued:

- Rail grade selection criteria based on an identification of the dominant damage mechanism
- Better understanding of degradation of joints and rails due to key phenomena such as wear, squat formation, corrugation and crack growth
- Comparison of different laboratory test setups of rail steel grades between each other and towards in-track behaviour
- Development of a novel application of Electron Back Scattered Diffraction techniques to study the depth of “microstructural damage” as a result of traffic in a range of different steel grades

- Comparative evaluation of grinding strategies & target profiles with operational recommendations

Also comparisons of different technologies have been carried out within this sub-project. As an example 3 new welding technologies have been compared.

### Cons

Track trials to study weld degradation planned in Germany/UK/ProRail were not possible to carry out within the INNOTRACK project, mainly due to lack of track availability.

## Logistics (SP5)

### Pros

INNOTRACK has made a significant step forward in logistics. This is especially important since there are existing directives in Europe in this area that have to be met.

Many questions and problem areas have been brought forward. Some of these are for the first time scrutinized in a structured and detailed manner in cooperation between infrastructure managers and rail contractors.

Several of the findings have now been taken over by bodies like EIM, CER and EFRTC. This is important since these organisations can deal with long-term questions in a manner that the time limitation in INNOTRACK prevents.

### Cons

It was difficult to conclude the result in a good way since the ambition level regarding changes turned out to be unrealistic. Another reason was that the views on logistics vary significantly between different infrastructure managers. Therefore it has not been possible to verify the result to an extent that would have been preferred.

## LCC (SP6)

### Pros

INNOTRACK has provided a major step forward to get Europe-wide acceptance of LCC and RAMS evaluation procedures. Furthermore, a much better common under

standing of RAMS and LCC has been achieved both in the supply industry and among infrastructure managers.

A guideline has been produced on LCC and RAMS for implementing the derived methods among different target groups like procurement departments and among the top management.

#### Cons

Today's use of LCC and RAMS was not as advanced as expected. Therefore the final result in INNTRACK did not fully reach the aims initial.

### Management and coordination (SP0)

#### Pros

The management structure used in INNTRACK has been successful in providing an effective steer to the INNTRACK project. It has been easy to take decisions and to make necessary changes without delays.

The chosen management structure has also made an effective coordination possible, particularly since INNTRACK was organised as a matrix project.

It has also been major advantage to have a professional management support in INNTRACK.

#### Cons

Participants with a smaller part in the INNTRACK project have had less influence in the steering of the project. To compensate this negative effect the project manager and the SP-leaders have spent extra time to inform these participants.

### Dissemination and training (SP7)

#### Pros

The positive engagement of railways, external to the INNTRACK project consortium, has made dissemination and training easier.

The detailed planning of the implementation stage of developed solutions during the lifetime of INNTRACK rather than at the end of the project has been a key positive decision with respect to dissemination and training.

Open questions have also been handled. More information is given in section "Open questions and how they are passed on" below.

#### Cons

The complex nature of the railway industry has made it necessary to tailor most dissemination and training activities.

### INNTRACK in the framework of EU programmes

In the INNTRACK Description of Work it was said that INNTRACK should benefit from other EU-projects. For EU projects where personal contacts were established in advance this worked very well. Examples of this are EUROBALT, ICON and WELDRAIL. For some other projects it was more difficult to get deeper information. This indicates the weakness of many EU-projects. They are too often not well documented for non-participants and the results seldom properly maintained.

### International research and development – a necessity

The railway system is very complex with some old and some new assets. It also covers a broad range of technical fields. Although this complexity and the increased duty arising from the anticipated growth in traffic indicates the need for considerably more resources, securing increased levels of technical support is not considered feasible. The only pragmatic approach to maintain a slimmed organisation and meet increasing demands at the same time, is international cooperation in R&D. INNTRACK has been very successful in this respect. A large number of good results have been produced and many international cooperations have been initiated within INNTRACK.

### Cooperation between industry and infrastructure managers is also a necessity!

During the last 10 to 15 years an important change has taken place in the relationship between infrastructure managers and the supply industry primarily with reference to the stricter adherence to purchasing regula-

tions. At the same time the need for good cooperation is becoming more and more important. The reason for this is that the infrastructure managers want the industry to deliver better performing products that can satisfy new demands particularly in a system context. These two needs are conflicting, but a reality. One way to cooperate in the future is through R&D projects like INNTRACK that represent a neutral playground allowing industry and infrastructure managers to cooperate and share knowledge in an open way. The importance of this cooperation is often underestimated.

As mentioned before, the industry delivers products that need to fit into a complex system. This system is complex due to many reasons like the different ages of the existing components, varying traffic situations, climate and many other factors. The knowledge on how the whole system works is essential to meeting the complex demands. In INNTRACK there are many good examples showing the importance of such knowledge being shared. This has been particularly evident in the research into rails, switches & crossings, and LCC. Cooperative research, as in INNTRACK, provides an effective methodology for the infrastructure managers to specify clearly their needs and for the industry to develop products and processes to meet these needs.

The coin has also another side. It is often not easy for the industry to convince infrastructure managers that their solution has a solid scientific foundation. In INNTRACK and similar projects the industry is given an opportunity to develop, test, verify, and demonstrate their products and processes in a more robust and scientifically valid manner. The study on the optimum use of premium rail grades undertaken in INNTRACK is a good example of this.

### Research and development in INNTRACK – an academic summary

Most results in INNTRACK have been presented as railway and industry R&D. In this section the results are looked at from an academic point of view. To do this one must have the process of R&D in mind. It is useful to consider the different stages of research, development and implementation as a continuous flow, see Figure 11-1. INNTRACK has clearly focused on the levels



Figure 11-1: The research, development and implementation process.

of "applied research", "development" and "implementation". It should be noted that INNTRACK has mainly been scrutinized from the point of view of the impact on implementation. This is relevant since the core topic of INNTRACK is innovative track systems. The main project objective of a 30% reduction of LCC is a further justification of the approach taken.

However, this also means that projects like INNTRACK are significantly dependent on fundamental research carried out outside of the project. This has definitely been the case in INNTRACK.

With reference to Figure 11-1, one can also note that in going from research, to development and to implementation a number of interfaces have to be dealt with. Here knowledge is passed on between persons and often between different organisations. In INNTRACK the aim has been to facilitate this communication by an efficient project organisation.

The scientific integrity of the research carried out in INNTRACK has been further assured by subjecting the deliverables of the project to a review by leading scientists in the relevant areas. The comments from the reviewers have been altogether positive and have facilitated an improvement in the level of scientific research. The con-

clusion from the scientific review process is that INNOTRACK has achieved a sound scientific level.

INNOTRACK has also had an appointed scientific leader, Dr Anders Ekberg from Chalmers University of Technology.

#### **Open questions and how they are passed on**

A project like INNOTRACK pushes the scientific and technological frontier in many areas. However, it will seldom establish the final solutions for all problems in an area. Therefore a legacy of all major projects is a significant amount of open questions.

The most important heritage from INNOTRACK consists of two items:

- The concrete results that have been developed and how these are implemented.
- The open questions and how these are handled.

In INNOTRACK we have tried to handle the open questions through two options. The first option is to hand them over to other bodies that can carry on with the work after INNOTRACK ends. This is the case, for example, with the standardization of hollow sleepers and with several “success critical areas” identified in the logistics sub-project. When a suitable body to pass the question on to cannot be identified easily, the remaining option is to document the open questions. This has been done in the deliverables and guidelines, and also in this concluding technical report, as is seen in chapters 4 to 7.

#### **Today's codes and standards are built on old and often empirical knowledge**

Finally, it should be remembered that current codes and standards are frequently built on old and often empirical and undocumented knowledge. Although significant amount of useful research into railway topics has been carried out in the recent past and continues to be undertaken, the application of the results has been slow. This was evident in INNOTRACK as many of the challenges encountered are due to the slow

incorporation of new knowledge. Hence, INNOTRACK has promoted a more efficient adoption of new knowledge. If the railway sector is to become more efficient and effective, it must implement new R&D faster. It is not acceptable that the regulations are based on old knowledge and (too often) not cost efficient techniques when improved knowledge is available. In INNOTRACK, this question has been addressed by making contacts with several regulatory bodies but it has not been totally solved. In the future, this question must be addressed if railway R&D is to be made fruitful.

A final key question regarding development is how to get products into market faster. The railway supply industry often and, quite correctly criticizes the infrastructure managers for the long time to market for railway products. Although this problem has not been solved in INNOTRACK, the results of several products, processes and methodologies have been implemented considerably faster than what is normally the case. In INNOTRACK we have shown that by doing R&D in cooperation between several participants, the acceptance for innovations is much higher.

This also relates to the question of how to use R&D results more efficiently: If codes and standards are old and there is no demand for new knowledge, the demand for R&D in the railway sector will decrease and will not be a high priority in the long-term. This would significantly reduce technical developments in the railway sector and become a serious handicap for the railway industry. Therefore the different regulatory bodies need to become much more aware of new knowledge and have a dialogue with projects like INNOTRACK.

## APPENDIX I – LIST OF INNOTRACK PARTNERS

## Appendix I

# List of INNOTRACK partners

---

UIC (co-ordinator)

UNIFE

European Federation of Railway Trackwork

Contractors

ADIF	Spain	Chalmers University of Technology	Sweden
Banverket	Sweden		
CD	Czech Republic	Laboratoire Central des Ponts et Chaussées	France
DB Netz	Germany	Manchester Metropolitan University	UK
Network Rail	UK		
ÖBB	Austria	Praha Technical University	Czech Rep
ProRail	Netherlands	TU Delft	Netherlands
Rail Safety & Standards Board	UK	University of Birmingham	UK
RFF	France	University of Karlsruhe	Germany
SNCF	France	University of Newcastle	UK
SZDC	Czech Republic	University of Southampton (ISVR)	UK
Alstom	France		
ARTTIC	France		
Balfour Beatty Rail	UK		
Carillion	UK		
Contraffice	Germany		
Corus	UK		
Damill	Sweden		
G-Impuls	Czech Republic		
Goldschmidt Thermit	Germany		
Speno International	Switzerland		
TenCate Geosynthetics	Austria		
VAE	Austria		
voestalpine Schienen	Austria		
Vossloh Cogifer	France		

## APPENDIX II – INNOTRACK DELIVERABLES

## Appendix II

# INNOTRACK deliverables

### Subproject 0: Project management

1. INNOTRACK Deliverable Do.1, Project management plans and quality assurance, 31 pp, 2007
2. INNOTRACK Deliverable Do.2, Periodic activity report year 1 *and* Periodic management report year 1, 66+60 pp, 2007
3. INNOTRACK Deliverable Do.3, Periodic activity report year 2 *and* Periodic management report year 2, 58 pp (and 1 annex 6 pp) + 57 pp, 2008
4. INNOTRACK Deliverable Do.4, Periodic activity report period 3 (September 2008 – December 2009), 67 pp (and 2 annexes 12+14 pp), 2010
5. INNOTRACK Deliverable Do.5, Publishable final activity report, 16 pp (and 1 annex 14 pp), 2010

### Subproject 1: Duty – requirements

#### Workpackage 1.1: Vehicle characteristics

6. INNOTRACK Deliverable D1.1.1, Database of representative vehicles and characteristics from participant countries, 8pp (and 4 annexes 1+2+8+1 pp), 2007
7. INNOTRACK Deliverable D1.1.2, Database of European generic vehicle characteristics, 14pp (and 3 annexes 2+5+1 pp), 2008

#### Workpackage 1.2: Track characteristics

8. INNOTRACK Deliverable D1.2.1, Standardised method for converting measured track data into segments for "virtual tracks", 11 pp, 2007
9. INNOTRACK Deliverable D1.2.2, Track sections and track irregularities analysis of DB sites, 45 pp, 2008
10. INNOTRACK Deliverable D1.2.4, Populated data base of track section characteristics for general modelling for design and LCC and specific problem segments, 30 pp, 2008
11. INNOTRACK Deliverable D1.2.5, Track segmentation, 22 pp (and 3 annexes 1+2+9 pp), 2009

#### Workpackage 1.3: Determining forces & stresses in track

12. INNOTRACK Deliverable D1.3.2, The state of the art of the simulation of vehicle track interaction as a method for determining track degradation rates. Part One – Strategic Models, 12 pp, 2008

13. INNOTRACK Deliverable D1.3.3, Final report on root causes of problem conditions and priorities for innovation, 18 pp, 2009
14. INNOTRACK Deliverable D1.3.4, Report on the most appropriate tools for evaluation of the issues raised within INNOTRACK where no proven method already exists and the Balfour Beatty Embedded Rail System; an example of technical evaluation, 21 pp (and 4 annexes 9+2+6+6 pp), 2009
15. INNOTRACK Deliverable D1.3.6, The state of the art of the simulation of vehicle track interaction as a method for determining track degradation rates Part 2 – High resolution models and the level of validation generally, 34 pp, 2009

#### Workpackage 1.4:

##### Information management framework

16. INNOTRACK Deliverable D1.4.1, Detailed framework for information and data collection, 11 pp (and 1 annex 11 pp), 2007
17. INNOTRACK Deliverable D1.4.2, Online database of numerical models and data analysis tools, 7 pp (and a database), 2008
18. INNOTRACK Deliverable D1.4.3, Process for the linking of modelling tools, 19 pp (and 4 annexes 1+3+3+7 pp), 2008
19. INNOTRACK Deliverable D1.4.4, On-line knowledge repository, 11 pp (and a database), 2009
20. INNOTRACK Deliverable D1.4.5, Linking of tools, 20 pp (and 1 annex 7 pp), 2009
21. INNOTRACK Deliverable D1.4.6, A report providing detailed analysis of the key railway infrastructure problems and recommendation as to how appropriate existing cost categories are for future data collection, 19 pp (and 19 annexes 47 pp in total), 2009
22. INNOTRACK Deliverable D1.4.7, Data mining of data sets, 31 pp (and 1 annex 3 pages), 2009
23. INNOTRACK Deliverable D1.4.8, Overall cost reduction, 34 pp (and 1 annex 3 pp), 2009
24. INNOTRACK Deliverable D1.4.9, Infrastructure maintenance cost breakdown structure – Guidance note, 12 pp, 2009
25. INNOTRACK Deliverable D1.4.10, Demonstrator: vehicle classification based on a wayside monitoring station, 21 pp, 2010

### Subproject 2: Support

#### Workpackage 2.1:

##### Track bed quality assessment

26. INNOTRACK Deliverable D2.1.1, In-situ measurement preliminary database, based on information management framework, 17 pp, 2008
27. INNOTRACK Deliverable D2.1.2, Adapted "Portancemetre" for track structure stiffness measurement on existing tracks, 27 pp (and 4 annexes 7+2+3+3 pp), 2007
28. INNOTRACK Deliverable D2.1.3, First phase report on the modelling of poor quality sites, 68 pp, 2008
29. INNOTRACK Deliverable D2.1.4, Report on sampling and analysis of geotechnical test results, 88 pp (and 1 annex 11 pp), 2009 [restricted to programme participants]
30. INNOTRACK Deliverable D2.1.5, Methodology of geophysical investigation of track defects, 28 pp, 2009
31. INNOTRACK Deliverable D2.1.6, RSMV stiffness measurements, 23 pp (and 1 annex 59 pp [extract]), 2009
32. INNOTRACK Deliverable D2.1.7, Investigations with PANDA / geoendoscope – Results and analysis of measurements, 44 pp (and 10 annexes 46+8+8+12+21+1+45+9+1+1 pp), 2009 [restricted to programme participants]
33. INNOTRACK Deliverable D2.1.8, In-situ measurement database, based on information management framework, 33 pp (and 2 annexes 82+24 pp), 2009 [restricted to programme participants]
34. INNOTRACK Deliverable D2.1.9, Adapted "Portancemetre" for track structure stiffness measurement on existing tracks, 56 pp (and 6 annexes 1+1+1+2+1+1 pp), 2009 [restricted to programme participants]
35. INNOTRACK Deliverable D2.1.10, Study of variation of vertical stiffness in transition zone, 94 pp (and 10 annexes 7+1+9+1+6+26+31+30+1+9 pp), 2009 [restricted to programme participants]
36. INNOTRACK Deliverable D2.1.11, Methods of track stiffness measurements, 36 pp, 2009
37. INNOTRACK Deliverable D2.1.12, Modelling of the track subgrade: Part 1: Final report on the modelling of poor quality sites. Part 2: Variability accounting in numerical modelling of the track subgrade, 33 pp, 2009
38. INNOTRACK Deliverable D2.1.13, Stiffness data processing and evaluation, 7 pp (and 1 annex, 9 pp), 2009

39. INNOTRACK Deliverable D2.1.14, Concluding update of D2.1.8, 30 pp (and 4 annexes 4+13+3+1 pp), 2009 [restricted to programme participants]
40. INNOTRACK Deliverable D2.1.15, Non-destructive geophysical methods, 17 pp (and 8 annexes, 16+10+13+10+7+7+9+6 pp), 2009 [restricted to programme participants]
41. INNOTRACK Deliverable D2.1.16, Final report on the modelling of poor quality sites, 98 pp, 2009 [restricted to programme participants]

#### Workpackage 2.2:

##### Subgrade improvement methods

42. INNOTRACK Deliverable D2.2.1, State of the art report on soil improvement methods and experience, 35 pp (and 2 annexes, 16+3 pp), 2008
43. INNOTRACK Deliverable D2.2.4, Description of measurement sites + LCC reference sites, 57 pp, 2009 [restricted to programme participants]
44. INNOTRACK Deliverable D2.2.5, Subgrade reinforcement with columns Part 1 Vertical columns, Part 2 Inclined columns, 122 pp (and 1 annex, 80 pp), 2009
45. INNOTRACK Deliverable D2.2.6, Guideline for subgrade reinforcement with geosynthetics. Part 1: Enhancement of track using under-ballast geosynthetics. Part 2: Improvement of transition zones on conventional lines, 46 pp, 2009
46. INNOTRACK Deliverable D2.2.7, Substructure improvement of a transition zone on a conventional rail line, 68 pp (and 2 annexes, 8+15 pp), 2009 [restricted to programme participants]
47. INNOTRACK Deliverable D2.2.8, Guideline for subgrade reinforcement with columns. Part 1 Vertical columns. Part 2 Inclined columns, 28 pp, 2009
48. INNOTRACK Deliverable D2.2.9, Subgrade reinforcement with geosynthetics, 178 pp, 2009 [restricted to programme participants]

#### Workpackage 2.3:

##### Superstructure improvements

49. INNOTRACK Deliverable D2.3.1, Validation methodology and criteria for the evaluation of frame type, unballasted or slab-track based superstructure innovations, 12 pp, 2008

50. INNOTRACK Deliverable D2.3.2, Optimised design of steel-concrete-steel track form, 56 pp (and 6 annexes, 4+5+1+2+1+2 pp), 2008 [restricted to programme participants]
51. INNOTRACK Deliverable D2.3.3, Design and manufacture of embedded rail slab track components, 32 pp, 2008
52. INNOTRACK Deliverable D2.3.4, Testing of the innovative BB ERS trackform, 40 pp (and 3 annexes, 22+15+1 pp), 2009
53. INNOTRACK Deliverable D2.3.5, A novel two-layer steel-concrete trackform for low maintenance s&c, 24 pp (and 1 annex, 13 pp), 2009
54. INNOTRACK Deliverable D2.3.6, Selection of a railway track system by best value analysis, 8 pp (and 2 annexes 3+6 pp), 2009

### Subproject 3: Switches and crossings

#### Workpackage 3.1: Switches and crossings

55. INNOTRACK Deliverable D3.1.1/D3.1.2, Definition of key parameters and Report on cost drivers for goal-directed innovation, 37 pp, 2008
56. INNOTRACK Deliverable D3.1.3, Draft specification of the s&c demonstrators, 19 pp, 2009
57. INNOTRACK Deliverable D3.1.4, Summary of results from simulations and optimisation of switches, 38 pp (and 4 annexes, 16+13+25+21 pp), 2009
58. INNOTRACK Deliverable D3.1.5, Recommendation of, and scientific basis for, optimisation of switches & crossings – part 1, 30 pp (and 2 annexes, 12+12 pp), 2009
59. INNOTRACK Deliverable D3.1.6, Recommendation of, and scientific basis for, optimisation of switches & crossings – part 2, 20 pp (and 3 annexes 10+14+16 pp), 2009
60. INNOTRACK Deliverable D3.1.7, Results from laboratory testing of frog materials in Kirchmöser, *to be delivered in September 2010*
61. INNOTRACK Deliverable D3.1.8, Results from field testing of frog materials in Haste, *to be delivered in December 2010*
62. INNOTRACK Deliverable D3.1.9, Results from field testing of switch panel support stiffness in Frankfurt and Wirtheim, *to be delivered in January 2011*
63. INNOTRACK Deliverable D3.1.10, Results from field testing of s&c support stiffness in Eslöv, *to be delivered in May 2011*
64. INNOTRACK Deliverable D3.1.11, Results of continuous RSMV stiffness measurements on switches at DB, 16 pp (and 7 annexes 1+1+1+1+1+1+1 pp), 2009 [confidential]

65. INNOTRACK Deliverable D3.1.12, Benefit from SP3 in terms of LCC, *to be delivered in July 2011*

#### Workpackage 3.2:

##### Driving and locking devices (DL)D

66. INNOTRACK Deliverable D3.2.1, Definition of acceptable RAMS and LCC for DLDS, 24 pp (and 1 annex, 4 pp), 2008 [confidential]
67. INNOTRACK Deliverable D3.2.2, Functional requirements for hollow sleepers for UIC 60 and similar types of switches, 12 pp (and 4 annexes, 4+1+4+1 pp), 2008
68. INNOTRACK Deliverable D3.2.3, Functional requirements for the open standard interface for electronic interlocking, 13 pp, 2009
69. INNOTRACK Deliverable D3.2.4/D3.3.5, Draft requirement specification for the DL and monitoring demonstrator, 16 pp, 2009
70. INNOTRACK Deliverable D3.2.5, Technical and RAMS requirements/recommendations for the actuation system, the locking and the detection device for UIC 60-300/1200 switches, 17 pp (and 1 annex, 1 pp), 2009

#### Workpackage 3.3: Monitoring systems

71. INNOTRACK Deliverable D3.3.1, List of key parameters for switch and crossing monitoring, 17 pp (and 7 annexes 14+5+2+2+1+1+1 pp), 2008
72. INNOTRACK Deliverable D3.3.2, Available sensors for railway environments for condition monitoring, 28 pp (and 1 annex 8 pp), 2009
73. INNOTRACK Deliverable D3.3.3, Requirements and functional description for s&c monitoring, 22 pp (and 1 annex 5 pp), 2009
74. INNOTRACK Deliverable D3.3.4, Algorithms for detection and diagnosis of faults on s&c, 35 pp (and 1 annex 9 pp), 2009
75. INNOTRACK Deliverable D3.3.6, Quantification of benefit available from switch and crossing monitoring, 21 pp, 2009

### Subproject 4: Rails and welding

#### Workpackage 4.1: Study of degradation of actual and new rail steels and joints

76. INNOTRACK Deliverable D4.1.1, Interim database for actual and new, innovative rail/joints, 15 pp (and 1 annex, 91 pp), 2008
77. INNOTRACK Deliverable D4.1.2, Interim rail degradation algorithms, 32 pp, 2008
78. INNOTRACK Deliverable D4.1.3, Interim guidelines on the selection of rail grades, 16 pp, 2008

79. INNOTRACK Deliverable D4.1.4, Rail degradation algorithms, 41 pp, 2009
80. INNOTRACK Deliverable D4.1.5, Definitive guidelines on the use of different rail grades, 45 pp, 2009

#### Workpackage 4.2: Validation of tolerances and limits for rails and joints

81. INNOTRACK Deliverable D4.2.1, The impact of vertical train-track interaction on rail and joint degradation, 22 pp (and 10 annexes, 27+25+10+12+6+8+7+7+25+4 pp), 2007
82. INNOTRACK Deliverable D4.2.2, Interim report on "minimum action" rules for selected defect types, 22 pp (and 4 annexes, 7+1+1+3 pp), 2007
83. INNOTRACK Deliverable D4.2.3 Improved model for loading and subsequent deterioration of insulated joints, 19 pp (and 1 annex, 17 pp), 2009
84. INNOTRACK Deliverable D4.2.4, Improved model for loading and subsequent deterioration due to squats and corrugation, 37 pp (and 7 annexes, 7+10+9+10+8+8+26 pp), 2009
85. INNOTRACK Deliverable D4.2.5, Improved model for the influence of vehicle conditions (wheel flats, speed, axle load) on the loading and subsequent deterioration of rails, 47 pp (and 6 annexes, 48+14+9+22+35+51 pp), 2009
86. INNOTRACK Deliverable D4.2.6, Recommendation of, and scientific basis for minimum action rules and maintenance limits, 126 pp (and 6 annexes, 9+8+10+9+10+33 pp), 2009

#### Workpackage 4.3: Innovative laboratory tests of rail steel grades and joints

87. INNOTRACK Deliverable D4.3.1, Initial definition of conditions for testing matrix of rail steels and welds, 11 pp (and 4 annexes 2+3+6+2 pp), 2007
88. INNOTRACK Deliverable D4.3.2, Characterisation of microstructural changes in surface & sub-surface layers of rails with traffic, 22 pp, 2007
89. INNOTRACK Deliverable D4.3.3, Results of first test rig measurements, 41 pp, 2008 [confidential]
90. INNOTRACK Deliverable D4.3.4, Calculation of contact stresses for laboratory test rigs, 23 pp (and 5 annexes, 6+7+30+27+4 pp), 2009
91. INNOTRACK Deliverable D4.3.5, Simulation of material deformation and RCF, 43 pp (and 2 annexes, 20+17 pp), 2009

92. INNOTRACK Deliverable D4.3.6, Characterisation of microstructural deformation as a function of rail grade, 30 pp, 2009
93. INNOTRACK Deliverable D4.3.7, Innovative laboratory tests for rail steels – Final report, 26 pp (and 1 annex, 5 pp), 2009
94. INNOTRACK Deliverable D4.3.8, Innovative laboratory tests for rail steels, 19 pp (and 1 annex, 6 pp), 2009

#### Workpackage 4.4:

##### Innovative inspection techniques

95. INNOTRACK Deliverable D4.4.1, Rail inspection technologies, 43 pp, 2008
96. INNOTRACK Deliverable D4.4.2, Operational evaluation of an inspection demonstrator (phase 1: laboratory and static tests), 94 pp (and 3 annexes 20+4+3 pp), 2009
97. INNOTRACK Deliverable D4.4.3, Evaluation of an inspection demonstrator (phase 2: Track tests), 25 pp, 2009

#### Workpackage 4.5:

##### Validation of new maintenance processes

98. INNOTRACK Deliverable D4.5.1, Overview of existing rail grinding strategies and new and optimised approaches for Europe, 8 pp (and 3 annexes, spreadsheet + 23 + 7 pp), 2007
99. INNOTRACK Deliverable D4.5.2, Target profiles, 10 pp, 2008
100. INNOTRACK Deliverable D4.5.3, Fields of improvement in grinding practices as input for LCC evaluations, 16 pp (and 2 annexes, 11+7 pp), 2009
101. INNOTRACK Deliverable D4.5.4, Friction management methods, 13 pp, 2009
102. INNOTRACK Deliverable D4.5.5, Guidelines for management of rail grinding, 20 pp, 2010

#### Workpackage 4.6:

##### Innovative welding processes

103. INNOTRACK Deliverable D4.6.1, The influence of the working procedures on the formation and shape of the HAZ of flash butt and aluminothermic welds in rails, 19 pp, 2008
104. INNOTRACK Deliverable D4.6.2, Report on the influence of the working procedures and post treatment on static and dynamic fatigue behaviour of aluminothermic welds, 13 pp, 2008
105. INNOTRACK Deliverable D4.6.3/D4.6.4, Analysis of equipment design and optimisation of parameters for gas pressure welding, 32 pp (and 3 annexes 1+2+5 pp), 2008

106. INNOTRACK Deliverable D4.6.5, Gas pressure welding – Quality of test welds, 15 pp (and 3 annexes 8+23+10 pp), 2009
107. INNOTRACK Deliverable D4.6.6, Weld performance in track test – supervision of weld properties in terms of rail profile, rail straightness and neutral temperature (preliminary report), 42 pp, 2009

### **Subproject 5: Logistics**

#### **Workpackage 5.1: Review of existing methods**

108. INNOTRACK Deliverable D5.1.1, Preliminary report on the existing state of the art for construction and maintenance activities of logistic constraints and definition document on logistics needs and constraints and definitions of benchmarks, 22 pp, 2008 [restricted availability]
109. INNOTRACK Deliverable D5.1.4, Preliminary report on conduct of interfaces between contractors and IM's and means of improvement, 16 pp, 2007 [restricted availability]
110. INNOTRACK Deliverable D5.1.5, Final report on existing states-of-the-art for construction, maintenance and renewal activities and assessment of logistic constraints, 21 pp (and 9 annexes 4+2+4+5+2+2+3+2+6+50), 2008 [confidential]
111. INNOTRACK Deliverable D5.1.6, Final report on conduct of interfaces between contractors and infrastructure managers and means of improvement, 34 pp, 2009 [confidential]
112. INNOTRACK Deliverable D5.1.7, Public report on construction, maintenance & renewal activities – conduct of interface between infra managers and contractors and suggested improvements, 14 pp, 2009

#### **Workpackage 5.2:**

##### **Design of validation procedures**

113. INNOTRACK Deliverable D5.2.1, Documented validation procedure, 20 pp, 2009
114. INNOTRACK Deliverable D5.2.3, Improved logistics from innotrack solutions, 50 pp, 2010

#### **Workpackage 5.3: Logistics and support**

115. INNOTRACK Deliverable D5.3.1, First report on logistics & support, 13 pp, 2009
116. INNOTRACK Deliverable D5.3.2, Final report on logistics & support, 18 pp, 2009

#### **Workpackage 5.4:**

##### **Logistics and switches and crossings**

117. INNOTRACK Deliverable D5.4.1, First report on the logistics of s&c, 16 pp, 2009
118. INNOTRACK Deliverable D5.4.2, Final Report on the logistics of s&c, 16 pp (and 2 annexes 1+1 pp), 2009

#### **Workpackage 5.5: Logistics and rail**

119. INNOTRACK Deliverable D5.5.1, First report on the logistics of rails, 15 pp, 2009
120. INNOTRACK Deliverable D5.5.2, Final report on the logistics of rails, 18 pp (and 1 appendix 8 pp), 2009

### **Subproject 6: Life cycle cost assessment**

#### **Workpackage 6.1: State of the art**

121. INNOTRACK Deliverable D6.1.1, Incorporated rules and standards, 16 pp (and 13 annexes 25+1+1+1+1+1+1+1+1+4+2+1+2 pp), 2007
122. INNOTRACK Deliverable D6.1.2, Models and tools, 24 pp (and 2 annexes 7+2 pp), 2007

#### **Workpackage 6.2: LCC – methodology**

123. INNOTRACK Deliverable D6.2.1, Unique boundary conditions, 35 pp, 2007
124. INNOTRACK Deliverable D6.2.2, Benchmark of LCC tools, 28 pp (and 4 annexes 11+17+5+2)
125. INNOTRACK Deliverable D6.2.4, Database and requirements (as input for WP6.5), 29 pp, 2009

#### **Workpackage 6.3: RAMS – Technology**

126. INNOTRACK Deliverable D6.3.1, Boundary conditions for RAM(s) analysis of railway infrastructure, 38 pp, 2009 [confidential]
127. INNOTRACK Deliverable D6.3.2, Requirements for RAMS analysis of railway infrastructure, 22 pp, 2009 [confidential]
128. INNOTRACK Deliverable D6.3.3, Necessary developments of RAMS technologies, 21 pp, 2009

#### **Workpackage 6.4:**

##### **RAMS and LCC in contracts/wordings/policies**

129. INNOTRACK Deliverable D6.4.1, Key values for LCC and RAMS, 20 pp (and 1 annex 17 pp), 2009
130. INNOTRACK Deliverable D6.4.2, Models and monitoring methods for LCC and RAMS relevant parameters, 24 pp (and 5 annexes 2+4+2+8+1 pp), 2009

#### **Workpackage 6.5: LCC and RAMS – analysis**

131. INNOTRACK Deliverable D6.5.1, Modular LCC/RAMS models for SP2 to SP5, 30 pp (and 4 annexes, 4+25+8+3), 2009
132. INNOTRACK Deliverable D6.5.3, Comparable LCC analysis for SP2 to SP5, 35 pp (and 6 annexes 8+4+2+4+4+1 pp), 2009 [confidential]
133. INNOTRACK Deliverable D6.5.4, Guideline for LCC and RAMS analysis, 101 pp (and 3 annexes 10+2+2 pp), 2009

### **Subproject 7: Dissemination and training**

#### **Workpackage 7.1: Dissemination platform**

134. INNOTRACK Deliverable D7.1.1, Set up of private and public project web-sites, 14 pp (and 2 annexes 26+6 pp)
135. INNOTRACK Deliverable D7.1.2, Set up of dissemination platform, 11 pp, 2006
136. INNOTRACK Deliverable D7.1.3, Planning report: set up of network of industries and infrastructure managers, 6 pp, 2006
137. INNOTRACK Deliverable D7.1.4, Report on the dissemination activities and proposal for further actions/update, 23 pp (and 1 annex 1p), 2008
138. INNOTRACK Deliverable D7.1.5, Identification of relevant codes and correlation to INNOTRACK results, 22 p, 2009
139. INNOTRACK Deliverable D7.1.6, Summary of dissemination and training – lessons learnt, 24 pp, 2009

#### **Workpackage 7.2: Training platform**

140. INNOTRACK Deliverable D7.2.1, Establishment of training platform, 17 pp (and 2 annexes 3+39 pp), 2007
141. INNOTRACK Deliverable D7.2.2, Report on training needs and plan for training programmes, 11 pp, 2009

#### **Workpackage 7.3: Technical reviewing**

142. INNOTRACK Deliverable D7.3.1, Set up the technical review & standardization platform, 4 pp (and 1 annex 9 pp), 2007
143. INNOTRACK Deliverable D7.3.2, Technical review platform (revision 2), 10 pp, 2008
144. INNOTRACK Deliverable D7.3.3, Experience from review work, 14 pp (and 3 annexes, 8+4+1 pp), 2009

## **APPENDIX III – INNOTRACK DATABASES**



## Appendix III

# INNOTRACK Databases

---

### **INNOTRACK Deliverable D1.1.1, Database of representative vehicles and characteristics from participant countries**

This database does not only consist of vehicles from the participating countries but also of vehicles from other countries. Since it is a valuable database for other users it will be maintained and, if needed, updated by the UIC.

### **INNOTRACK Deliverable D1.1.2, Database of European generic vehicle characteristics**

This database is also deemed useful for future use and will be maintained and, if needed, updated by the UIC.

### **INNOTRACK Deliverable D1.2.4, Populated data base of track section characteristics for general modelling for design and LCC and specific problem segments**

This database was used for a specific purpose in the project. It is available on the public website but will not be maintained, nor updated.

### **INNOTRACK Deliverable D1.4.2, Online database of numerical models and data analysis tools**

This database was used for a specific purpose in the project. It is available on the public website but will not be maintained, nor updated.

### **INNOTRACK Deliverable D2.1.1, In-situ measurement preliminary database, based on information management framework**

This database will not be maintained since it has been replaced by deliverable D2.1.8. It is available on the public website.

### **INNOTRACK Deliverable D2.1.8, In-situ measurement database, based on information management framework**

This database is an update of the version reported in deliverable D2.1.1. It has been deemed useful for future use and will be maintained and, if needed, updated by the UIC.

### **INNOTRACK Deliverable D4.1.1, Interim database for actual and new, innovative rail/joints**

This database will not be maintained since it was intended as a working document. It is available on the public website.

### **INNOTRACK Deliverable D6.2.4, Database and requirements (as input for WP6.5)**

This database will not be maintained since it was a project specific working document. It is available on the public website.

### **The knowledge management system (KMS) at the UIC**

This database has been acting as a document storage area during the work with INNOTRACK. It will now be tidied up. All administrative documents will be taken away and only important documents, such as deliverables, will be maintained and kept easy to assess.

# APPENDIX IV – INNOTRACK GUIDELINES

## Appendix IV

# INNOTRACK Guidelines

---

1. INNOTRACK Deliverable D2.1.5, Methodology of geophysical investigation of track defects, 28 pp, 2009
2. INNOTRACK Deliverable D2.1.11, Methods of track stiffness measurements, 36 pp, 2009
3. INNOTRACK Deliverable D2.1.12, Modelling of the track subgrade: Part 1: Final report on the modelling of poor quality sites. Part 2: Variability accounting in numerical modelling of the track subgrade, 33 pp, 2009
4. INNOTRACK Deliverable D2.2.6, Guideline for subgrade reinforcement with geosynthetics. Part 1: Enhancement of track using under-ballast geosynthetics. Part 2: Improvement of transition zones on conventional lines, 46 pp, 2009
5. INNOTRACK Deliverable D2.2.8, Guideline for subgrade reinforcement with columns. Part 1 Vertical columns. Part 2 Inclined columns, 28 pp, 2009
6. INNOTRACK Deliverable D2.3.5, A novel two-layer steel-concrete trackform for low maintenance s&c, 24 pp (and 1 annex, 13 pp), 2009
7. INNOTRACK Deliverable D2.3.6, Selection of a railway track system by best value analysis, 8 pp (and 2 annexes 3+6 pp), 2009
8. INNOTRACK Deliverable D3.1.5, Recommendation of, and scientific basis for, optimisation of switches & crossings – part 1, 30 pp (and 2 annexes, 12+12 pp), 2009
9. INNOTRACK Deliverable D3.1.6, Recommendation of, and scientific basis for, optimisation of switches & crossings – part 2, 20 pp (and 3 annexes 10+14+16 pp), 2009
10. INNOTRACK Deliverable D3.2.2, Functional requirements for hollow sleepers for UIC 60 and similar types of switches, 12 pp (and 4 annexes, 4+1+4+1 pp), 2008
11. INNOTRACK Deliverable D4.1.5, Definitive guidelines on the use of different rail grades, 45 pp, 2009
12. INNOTRACK Deliverable D4.2.6, Recommendation of, and scientific basis for minimum action rules and maintenance limits, 126 pp (and 6 annexes, 9+8+10+9+10+33 pp), 2009
13. INNOTRACK Deliverable D4.3.8, Innovative laboratory tests for rail steels, 19 pp (and 1 annex, 6 pp), 2009
14. INNOTRACK Deliverable D4.5.5, Guidelines for management of rail grinding, 20 pp, 2010
15. INNOTRACK Deliverable D5.2.3, Improved logistics from innotrack solutions, 50 pp, 2010
16. INNOTRACK Deliverable D6.5.4, Guideline for LCC and RAMS analysis, 101 pp (and 3 annexes 10+2+2 pp), 2009

## APPENDIX V – INNOTRACK RELATED PUBLICATIONS AND PRESENTATIONS

## Appendix V

# INNOTRACK Related publications and presentations

---

Presentations on INNOTRACK have been given at several important conferences, including:

- World congress on railway research (WCRR) in Montreal (2006) and in Seoul (2008).
- Contact mechanics and wear of rail/wheel systems (cm) in Queensland (2006) and in Florence (2009).
- InnoTrans 2008 in Berlin.
- International heavy haul conference (IHHA) in Kiruna (2007) and in Shanghai (2009).

The overall presentation on INNOTRACK results given in Shanghai:

Björn Paulsson & Anders Ekberg, Results to exemplify the joint EU-project INNOTRACK - Innovative Track systems

has been accepted for a special issue of the Journal of Rail and Rapid Transit.

An overview of INNOTRACK has been given in

Björn Paulsson & Anders Ekberg, Cutting the life-cycle cost of track, Railway Gazette International, January 2010, pp 48-51

A special issue of IMechE Journal of Rail and Rapid Transit in 2010 will feature the following papers:

- Barta, Methodology of geophysical investigation of track defects
- Bezin and Farrington, A structural study of an innovative steel-concrete track structure
- Jirousek et al, Numerical modelling of the reinforcing effect of geosynthetic material used in ballasted railway track
- Horníček et al, Investigation of the effect of under-ballast reinforcing geogrids in laboratory and operating conditions
- Nicklisch et al, Optimisation of geometry and stiffness of switches & crossings, and simulation of material degradation
- Silmon and Roberts, Improving switch system reliability with innovative condition monitoring techniques
- Kabo et al, Rolling contact fatigue prediction for rails and comparisons to test rig results

- Bouch and Roberts, State-of-the-art for construction, maintenance and renewal logistics activities
- Bouch, Roberts and Amoores, Development of a common set of european high-level track maintenance cost categories

In addition there are many scientific papers that are devoted, fully or partially, to research results from INNOTRACK. Many of these are listed as references in the INNOTRACK deliverable reports and guidelines.

## APPENDIX VI – A LIST OF IMPLEMENTABLE RESULTS FROM INNOTRACK

## Appendix VI

# A list of implementable results from INNOTRACK

	Operational implementation			Research implementation		
	Standalone report Codes/Product	Tools Database	Tools Database	Data/Knowledge Tools	Impact on RAMS & Env. Database	Impact on RAMS & Env. Database
D1.1.1 Database of representative vehicle types and characteristics from participant countries. Database of vehicle data.				●		●
D1.1.2 Database of European Generic Vehicle Characteristics Database of European vehicles. Generic model for multiple unit vehicle.				●		●
D1.2.1 Standardised method for converting measured track data into segments for "virtual tracks". Numerical generation of representative track segments.				●		●
D1.2.2 Identification of critical track segments. Correlation analysis between failures, maintenance and costs and line routing data, track design and operational conditions. Structured catalogue of track faults. Identification of cost drivers.		●				●
D1.2.4 Definition of track irregularities. Database of track section characteristics for typical sections with faults. Related data of operating vehicles.						●
D1.2.5 Track segmentation. Guidelines for track segmentation. Analysis of track recording coach data. Numerical tools for track segmentation and data analysis. Data on track conditions.		●				●
D1.3.2 Report on the state of the art of the simulation of vehicle track interaction as track degradation rates. Overview of six numerical toolboxes for strategic decision making.						●
D1.3.3 The root causes of problem conditions and priorities for innovation. State-of-the-art of track deterioration mechanisms. Background deterioration data for prioritizing research/development.						●
D1.3.4 Report on the most appropriate tools for method already exists. Framework for technical assessment and FMECA analysis of innovative solutions with case study. Technical approval of BBEST slab track solution.		●				●
D1.3.6 Report on the state of the art of the simulation of vehicle track interaction as a method for determining track degradation rates. Part2. High Resolution Models and the Degree of Validation of Models Generally. Overview and classification of numerical models for vehicle-track interaction and pertinent track degradation.						●
D1.4.1 Detailed Framework for Information and Data Collection Track problem related data.						●
D1.4.2 Database of models and list of potential model gaps. Database of numerical toolboxes for simulation of different aspects of track loading and deterioration.						●
D1.4.3 Process for the linking of modelling tools. Transfer format for simulation data and models. Data export/import/transfer programs and/or routines for simulation programs.		●				

	Operational implementation			Research implementation		
	Standalone report Codes/Product	Tools Database	Tools Database	Data/Knowledge Tools	Impact on RAMS & Env. Database	Impact on RAMS & Env. Database
D1.4.4 Completed knowledge repository available online and data mining routines for system wide analysis. Measurement train data. Track information data. Wheel impact load data.						●
D1.4.5 Prototype linking of multiple tools to aid with an appropriate case study. Outline of XML scheme for link indata and output of different numerical tools.						●
D1.4.6 A report providing detailed analysis of the key railway infrastructure problems and recommendation as to how appropriate cost categories for future data collection. Common European cost and maintenance structures. Compilation of cost drivers. Mitigation of cost drivers. Better (more clear) reporting routines.						●
D1.4.7 Data mining of data sets. Exemplification on how to mine data collected in INNOTRACK to draw practical conclusions (e.g. On maintenance needs).						●
D1.4.8 Overall Cost Reduction. Evaluation of cost savings as basis for prioritizations Method of deriving overall cost savings of innovative solutions Exemplification of detailed LCC evaluations						●
D1.4.9 Cost data collection. Proposed breakdown structure of track maintenance cost categories as basis for future standardization						●
D1.4.10 Demonstrator: vehicle classification based on wayside monitoring station Wayside monitoring station to evaluate track forces and steering behaviour on a vehicle basis Comparison of wayside monitoring systems Innovative approach to vehicle classification based on monitoring data						●
D2.1.1 In-situ measurement preliminary database, based on information management framework. Database for track and subgrade/subsoil data. Structure for defining data sets in the database of track and subgrade/subsoil data.						●
D2.1.2 Prototype of adapted Portancemeter for track substructure stiffness measurement on existing tracks. Evaluation of needed characteristics for a portancemeter for railway use. First version of a portancemeter for railway use.						●
D2.1.3 First phase report on the modelling of poor quality sites. Test box to measure sleeper deflection. Measured deflections under different ballast/sub-ballast/foundation conditions. Numerical (FE) models validated towards experiments. Design graphs to obtain a specified deformation modulus.						●
D2.1.4 Report on test results and sampling. Results from field tests, comparison of methods of sounding. Labtests Application of the concept onset of settlements: requirements and results.						●
D2.1.5 GL Methodology of geophysical investigation of railway track defects. Geophysical measurement.						●

	Operational implementation			Research implementation		
	Standalone report Process/Product Codes/Norms	Database Tools	Impact on RAMS & Env. Database	Data/Knowledge Tools	Database	Impact on RAMS & Env. Database
<b>D2.1.6 RSMV stiffness measurements</b>						
Results from field tests.			●	●	●	●
Comparison with other methods.	●			●	●	●
<b>D2.1.7 Investigation with geo-endoscopy and penetrometer.</b>						
Results from field tests.			●	●	●	●
Comparison with other methods.	●			●	●	●
<b>D2.1.8 Update of D211 – Database.</b>						
Database for track and subgrade/subsoil data.				●		●
Structure for defining data sets in the database of track and subgrade/subsoil data.		●				
Applications		●		●	●	
<b>D2.1.9 Report on measurements campaign with railway portancemeter.</b>						
Results from field tests.			●	●	●	●
Comparison with other methods.				●	●	●
Portancemeter tool.			●			
<b>D2.1.10 Study of variation of the vertical stiffness in transition zone.</b>						
Data base of track stiffness variation for operating vehicles.				●		●
Data of track condition.				●		●
Measurement train – track data.				●		
Influence of the traveling condition in the track stiffness values.		●			●	
Variation of the vertical stiffness in transition zones.		●			●	
<b>D2.1.11 GL Methods of track stiffness measurement.</b>						
Test of different tools for track stiffness measurement.			●	●	●	●
Comparison with other methods.	●			●	●	●
Development of portancemeter.			●	●	●	●
<b>D2.1.12 GL Modelling of the track subgrade.</b>						
Part 1: final report on the modelling of poor quality sites.						
Part 2: final report on numerical modelling.						
Test box to measure sleeper deflection.			●		●	
Measured deflections under different ballast/sub-ballast/foundation conditions.			●		●	
Numerical (FE) models validated towards experiments.			●		●	
Design graphs to obtain a specified deformation modulus.	●	●				
Stochastic approach for variability accounting.			●	●	●	●
<b>D2.1.13 Stiffnes data processing and evaluation</b>						
Method to deriving track quality information from measured data on track stiffness, track geometry and ground penetration radar.	●	●	●	●	●	●
<b>D2.1.14 Concluding update of D218.</b>						
Database for track and subgrade/subsoil data.				●		●
Structure for defining data sets in the database of track and subgrade/subsoil data.		●				
Applications		●		●	●	
Overview and selected examples.		●				
<b>D2.1.15 Non-destructive geophysical methods.</b>						
Review of geophysical measurement methods.	●	●	●	●	●	●
<b>D2.1.16 Final report on the modelling of poor quality site.</b>						
Test box to measure sleeper deflection.			●		●	
Measured deflections under different ballast/sub-ballast/foundation conditions.			●		●	
Numerical (FE) models validated towards experiments.			●		●	
Design graphs to obtain a specified deformation modulus.	●	●				
Stochastic approach for variability accounting.			●	●	●	●

	Operational implementation			Research implementation		
	Standalone report Process/Product Codes/Norms	Database Tools	Impact on RAMS & Env. Database	Data/Knowledge Tools	Database	Impact on RAMS & Env. Database
<b>D2.2.1 State of the art report on soil improvement methods and experiences.</b>						
Overview of soil improvement methods with indication of: purpose, area of application, standards, specifications and implementation status among INNOTRACK partners.			●			●
<b>D2.2.4 Description of measurement sites + LCC reference sites.</b>						
Characteristics of measurement sites to be used together with measurement database.		●		●		●
<b>D2.2.5 Subgrade reinforcement with columns.</b>						
Part 1: vertical columns Part 2: inclined columns.						
Efficiency of track subgrade improvement methods.		●			●	●
Numerical modelling.		●	●		●	●
Data of track condition.				●		●
Measurement train – track data.				●		
<b>D2.2.6 GL Subgrade reinforcement with geosynthetics.</b>						
Part 1: enhancement of track using under-ballast geosynthetics.						
Part 2: Improvement study of transition zone on conventional line.						
Test box to measure sleeper deflection.				●		●
Measured deflections by using different geosynthetics.				●		●
Numerical (FE) models validated towards experiments.				●		●
Design graphs to obtain a specified deformation modulus.	●	●				
Field measurements and evaluation.	●	●				●
<b>D2.2.7 GL Improvement study of transition zone on conventional line.</b>						
Efficiency of track superstructure improvement methods.		●			●	●
Evaluation of problems in railway embankments transition zones.		●			●	●
Data base of track stiffness variation for operating vehicles.				●		●
Data of track condition.				●		●
Measurement train – track data.				●		
<b>D2.2.8 GL Guidelines for subgrade reinforcement with columns.</b>						
Part 1: vertical columns and Part 2: inclined columns.						
Efficiency of track subgrade improvement methods.		●			●	●
Numerical modelling.		●	●		●	●
Data of track condition.				●		●
Measurement train - track data.				●		
<b>D2.2.9 Subgrade reinforcement with geosynthetics: Enhancement of track using under-ballast geosynthetics.</b>						
Test box to measure sleeper deflection.				●		●
Measured deflections by using different geosynthetics.		●			●	
Numerical (FE) models validated towards experiments.		●			●	
Design graphs to obtain a specified deformation modulus.	●	●				
Field measurements and evaluation.	●	●				●
<b>D2.3.1 Validation methodology and criteria for evaluations of superstructure innovations.</b>						
Evaluation criteria for innovative superstructure solutions.		●			●	
<b>D2.3.2 Optimised design of a steel-concrete-steel track form to provide consistent support for low maintenance operation based on modelling and laboratory testing.</b>						
Innovative steel-concrete-steel track form.		●				●
Evaluation of deflection, stresses, fatigue, noise emission etc of steel-concrete-steel track form as basis for maintenance and operational limits.	●					●
<b>D2.3.3 Design and Manufacture of BBEST slab track components.</b>						
Innovative embedded slab-track solution.		●				●
Evaluation of deflection, stresses, fatigue, noise emission etc of steel-concrete-steel track form as basis for maintenance and operational limits.		●			●	●

	Operational implementation			Research implementation		
	Standalone report Process/Product Codes/Norms	Database Tools	Impact on RAMS & Env. Database	Data/Knowledge Tools	Database	Impact on RAMS & Env. Database
D2.3.4 Test results for the BBEST slab track components. Innovative embedded slab-track solution. Evaluation of components.		●		●	●	●
D2.3.5 Report for dissemination on the appropriate applications of the Corus slab track. Innovative steel-concrete-steel track form.		●				●
D2.3.6 Joint reports on the benefits of superstructure innovations. Innovative steel-concrete-steel track form. Innovative embedded slab-track solution.		●				●
D3.1.1 Definition of key parameters and constraints in optimisation of S&C. Ranking of S&C related problems as basis for prioritization and optimisation. Break-down of cost drivers per S&C type. Identification of main cost drivers and comparison between two infra-managers as basis for benchmarking and optimisations.		●		●	●	●
D3.1.3 Draft specification of the S&C demonstrator. Test plan for S&C demonstrators.		●	●			
D3.1.4 Summary of results from simulations and optimisation of switches. Benchmark of different numerical models for predicting contact forces in switches. Comparison of numerical simulations to infield measurements of contact forces. Optimisation of dynamic track gauge in switches. Optimisation of geometry and support stiffness in crossing panels. Models of dynamic vehicle-turnout interaction.			●		●	●
D3.1.5 GL Recommendation of, and scientific basis for optimization of switches & crossings – part I. Optimization of track gauge variation, and quantification of benefits in terms of decreased track forces, wear and risk of RCF. Optimization of crossing geometry and quantification of benefits in terms of decreased contact forces. Optimization of crossing support stiffness and quantification of benefits in terms of decreased track forces, wear and risk of RCF.		●	●	●	●	●
D3.1.6 GL Recommendation of, and scientific basis for optimization of switches & crossings. Methodology for validated prediction of contact forces and resulting plastic deformation, wear and RCF. Quantification of the influence of increased axle load on switch deterioration through numerical simulations. Quantification of crossing nose deterioration through plastic deformation and wear through numerical simulations. Cyclic elasto-plastic material data (including fatigue data) for 3 switch materials.		●	●	●	●	●
D3.1.11 Results of continuous RSMV stiffness measurements on switches at DB Novel techniques for measuring track stiffness at switches and crossings. Data on track stiffness in switches and crossings for comparative studies.	●	●	●	●	●	●
D3.2.1 Definition of acceptable RAMS and LCC for DLD's. Overview of DLDs used in different countries. Method for LCC evaluation of DLDs. Method for RAMS analysis of DLDs. Acceptable (and realistic) RAMS and LCC targets for purchasing etc.		●		●		●
D3.2.2 GL Functional requirements for hollow sleepers for UIC 60 switches. Functional requirements for hollow sleepers as basis for codes and standardisation.	●					●

	Operational implementation			Research implementation		
	Standalone report Process/Product Codes/Norms	Database Tools	Impact on RAMS & Env. Database	Data/Knowledge Tools	Database	Impact on RAMS & Env. Database
D3.2.3 Functional Requirements for the open standard interface for electronic interlocking. Detailed functional requirements for an open standard interface for electronic interlocking.		●	●			●
D3.2.5 Technical and RAMS requirements/recommendations for the actuation system, the locking and the detection device for UIC 60-300/1200 switches. Detailed technical and RAMS requirements for DLD devices.		●	●			●
D3.3.1 List of key parameters for switch and crossing monitoring. Structured decomposition of the components of a generic switch as basis for e.g. improved fault reports. Failure mode effects and criticality analysis as basis for design optimisations. Analysis of the occurrence of different failure types as basis for design optimisation.		●	●	●		●
D3.3.2 Available sensors for railway environments for condition monitoring. Compilation of types of faults of switch actuators and the number of occurrences as a basis for design development. Categorisation of faults as a basis for refined detection. Testing of the influence of the faults on measurable parameters as a foundation for detection equipment. Quantification of which measurable parameters that can indicate which fault.		●	●			●
D3.3.3 Requirements and functional description for S&C monitoring. A structured list of requirements for S&C monitoring.		●				
D3.3.4 Algorithms for detection and diagnosis of faults on S&C. Survey of fault detection and diagnosis algorithms and their applicability for switches.			●			●
D3.3.5 Draft specification of the monitoring demonstrator. A structured list of requirements for a DLD and monitoring demonstrator.						●
D3.3.6 Quantification of benefits available from switch and crossing monitoring. Definition of five levels of S&C monitoring including description of how to upgrade to a higher level and pertinent benefits. Two LCC evaluation schemes for calculating financial benefits of S&C monitoring.		●	●			●
D4.1.1 A database for actual and new, innovative rail/joints. Database with long-term degradation data from rail manufacturers and infra-managers.				●		●
D4.1.2 Interim rail degradation algorithms. Empirical predictive formulas for wear as function of operational conditions and rail grade. Correlation between track based circumstances, operational situation and crack growth rates.		●		●		●
D4.1.3 Interim guidelines on the selection of rail grades. Compilation of rail grade selections throughout Europe as basis for standardisations. A first recommendation for updating guidelines w.r.t. rail grade selection (UIC 721).		●				●
D4.1.4 Rail Degradation. Empirical predictive formulas for wear as function of operational conditions and rail grade. Correlation between track based circumstances, operational situation and crack growth rates.		●		●		●

	Operational implementation			Research implementation		
	Standalone report Process/Product Codes/Norms	Database Tools	Database Tools	Data/Knowledge Tools	Database Tools	Impact on RAMS & Env. Database Tools
D4.1.5 GL Definitive guidelines on the use of different rail grades according to duty conditions and based on RAMS and LCC principles. A recommendation for updating guidelines w.r.t. rail grade selection (UIC 721).	●					●
D4.2.1 Estimations of the influence of rail/joint degradation on operational loads and subsequent deterioration. Tentative report. Knowledge on frequency content in contact loads from operations on corrugated track / with out-of-round wheels as basis for standards of wheel-rail contact force measurements. Influence of parameters such as axle load, speed, corrugation magnitude etc on wheel-rail contact forces on operations on corrugated tracks as basis for regulations on allowed load and maintenance practices. Numerical tools to predict rolling contact fatigue impact for operations on corrugated track / with out-of-round wheels. Influence of insulated joint dip on vertical contact forces as input to allowed magnitudes and maintenance practices. Numerical tools to predict loading of and stresses/strains at an insulated joint. Numerical tools to calculate the influence of squats on contact stresses. Influence of parameters such as traction/braking, unsprung mass, welds etc. on squat loading as basis for maintenance practices.	●	●	●		●	●
D4.2.2 Interim report on "Minimum Action" rules for selected defect types. Outlining of a statistical approach to minimum action rules.			●	●	●	
D4.2.3 Improved model for loading and subsequent deterioration due to point-like rail defects (e.g. insulated joints). Influence of parameters such as width of insulating layer, loading etc on predicted deterioration of joints as basis for regulations on design, placement and maintenance. Numerical models to simulate the deterioration of an insulated joint. Field monitoring over half a year of the deterioration of an operational insulated joint and relation to pertinent traffic load.	●	●	●		●	●
D4.2.4 Improved model for loading and subsequent deterioration due to distributed rail defects (e.g. squats and rail corrugation). Correlation between the occurrence of squats with the locations of welds as a basis for regulations on welds and maintenance practices. Numerical toolbox to predict squat initiation. Identification of critical size for a surface defect to grow into a squat as basis for allowed surface irregularities and maintenance practices. Knowledge on squat growth from in-field monitoring for refining maintenance practices. Knowledge of the variation in corrugation spectra between lines as basis for measurement, detection and maintenance practices. Influence of speed and roughness levels on rolling contact fatigue impact and rolling noise as basis for regulations and maintenance practices. Numerical toolbox for prediction of noise emission and rolling contact fatigue impact at operations on corrugated rails and/or with out-of-round wheels. Knowledge of wavelength characteristics of squats as basis for detection.	●	●		●	●	●
D4.2.5 Improved model for the influence of vehicle conditions (wheel flats, speed, axle load etc) on the loading and subsequent deterioration of rails. Quantification of the influence of wheel-rail hardness correlation, applied traction and wheel out-of-roundness on wear rates as basis for regulations and design practices. Hardness evolution under conditions of varying hardness of wheel and rail. Numerical toolbox for wear prediction. Numerical toolbox for growth of short railhead cracks. Numerical toolbox for prediction of operationally induced bending of rails and subsequent long crack growth.	●	●		●	●	●

	Operational implementation			Research implementation		
	Standalone report Process/Product Codes/Norms	Database Tools	Database Tools	Data/Knowledge Tools	Database Tools	Impact on RAMS & Env. Database Tools
D4.2.5 continued						
Prediction of wheel impact load corresponding to rail breaks under varying operational conditions (speeds, axle loads, vehicle type, track stiffness, temperature) as basis for regulations and maintenance practices.	●	●	●			●
Prediction of growth rates of long rail cracks under varying operational conditions as a basis for maintenance regulations, practices and planning.	●	●	●			●
D4.2.6 GL Recommendation of, and scientific basis for minimum action rules and maintenance limits. Overview of current minimum action rules in Europe. Determination of critical size for squat growth. Guidelines for squat detection. Guidelines for squat countermeasures. Definition of corrugation characteristics in terms of wavelength spectrum. Operational acceptance criterion for allowed corrugation accountin for noise emission and risk for RCF. Guidelines for wear limitation. Recommendation of documentation practices in relation to rail wear documentation. Quantification of the influence of insulated joint dip, insulating layer width and load magnitudes on joint deterioration. Quantification of mitigating effects of modifications such as rail edge bevelling, insulation material stiffness, laterally inclined joints. Recommendations for insulated joint design under different operational conditions. Definition of standardized wheel flat geometry and simplified contact force history related to wheel flat impact based on field measurements and numerical simulations. Approximate relations to relate wheel-rail contact loads from quasi-static and wheel flat impact to rail bending moments based on field measurements and numerical simulations. Approximate stress intensity factors for rail head and foot cracks. Derivation of fracture risks as function of rail crack size, wheel-rail impact load, ballast stiffness, temperature, vehicle type etc. Derivation of crack growth rates as function of rail crack size, wheel-rail impact load, ballast stiffness, temperature, vehicle type etc. Recommendation of practices to avoid rail breaks. Predictive model to evaluate the risk of rail breaks as function of distributions of load, defect size, temperature etc. Estimations of possible savings related to RCF, corrugation and squat management.	●	●			●	●
D4.3.1 Initial definition of conditions for testing matrix of rail steels and welds. Information on available test benches. Structured definition of test parameters to build specifications from.			●			●
D4.3.2 Characterisation of microstructural changes in surface and sub-surface layers with traffic. Development and validation of a method of defining damaged material based on misorientation of the material microstructure. Establishment of a relationship between surface crack length and crack depth as basis for estimations of needed grinding depths, classification of damage etc. Evaluation of depth of damaged rail surface layer for different rail grades under different conditions as background for e.g. needed grinding depths.	●		●		●	●
D4.3.3 Test results of first test rig measurements. Times to crack initiation under different test bench conditions. Rail profile evolution under different test bench conditions.						●

	Operational implementation			Research implementation		
	Standalone report Process/Product Codes/Norms	Database Tools	Database Tools	Data/Knowledge Tools	Impact on RAMS & Env. Database	Impact on RAMS & Env. Database
<b>D4.3.4 Calculation of contact stresses and wear.</b> Development and validation of a method for evaluating wheel-rail contact stress distributions under different test rig conditions. Comparison of evaluated contact stresses and test bench results to improve test procedures and numerical predictions. Input to which parameters should be monitored during test bench experim. Comparison of contact stress magnitudes for different test rig configurations.				●	●	
<b>D4.3.5 Simulation of material deformation and RCF.</b> Identification of parameters needed to be monitored in rail tests and their relative influence on predicted RCF lives. Predictive model for RCF life of rails calibrated towards laboratory test results. Evaluation of the sensitivity of conformal contacts on RCF life predictions.	●	●	●		●	●
<b>D4.3.6 Microstructural deformation as a function of rail grade.</b> Further development and validation of a method of defining damaged material based on misorientation of the material micro-structure using samples from laboratory testing. Evaluation of depth of damaged rail surface layer for different rail grades under different conditions as background for e.g. needed grinding depths.	●		●	●		
<b>D4.3.7 Innovative laboratory tests for rail steels.</b> Overview of capabilities of laboratory tests of rail-wheel rolling contact. Results from tests carried out in INNOTRACK in terms of wear and RCF evolution. Description of procedures and capabilities of numerical simulations of test configurations; evaluation of contact stresses and prediction of RCF life. Description of, which data to collect and how to report it in connection to laboratory tests.		●	●		●	●
<b>D4.3.8 GL Guideline for laboratory tests for rail steels.</b> Overview of capabilities of laboratory tests of rail-wheel rolling contact. Quantification of testing efforts at the different facilities. Results from tests carried out in INNOTRACK in terms of wear and RCF evolution. Description of procedures and capabilities of numerical simulations of test configurations; evaluation of contact stresses and prediction of RCF life Description of, which data to collect and how to report it in connection to laboratory tests.		●	●		●	●
<b>D4.4.1 Assessment of rail inspection technologies in terms of industrial ripeness ????</b> Overview of MDT techniques. Overview of NDT techniques employed world-wide.		●	●		●	●
<b>D4.4.2 Operational evaluation of a multifunctional inspection equipment (phase 1 : laboratory and static tests).</b> Structured samples of real and manufactured defects for testing of inspection equipment. Evaluation of available inspection method's abilities to detect defects. Evaluation of innovative inspection techniques to detect defects. Evaluation of further market qualities (maturity, cost etc) for innovative techniques. Toolbox for mapping inspection results to infrastructure assets (not developed in the frame of INNOTRACK).	●	●	●		●	●
<b>D4.4.3 Operational evaluation of a multifunctional inspection equipment (phase 2 : track tests).</b> Relevance of rail defect detection by trolley inspection. Assessment of rail defects through 3 different innovative techniques (comparison with laboratory tests and other detection methods). Further development and evaluation of innovative inspection technologies by track tests on a railway.	●	●	●		●	●

	Operational implementation			Research implementation		
	Standalone report Process/Product Codes/Norms	Database Tools	Database Tools	Data/Knowledge Tools	Impact on RAMS & Env. Database	Impact on RAMS & Env. Database
<b>D4.5.1 Overview of existing rail grinding strategies and new and optimised approaches for Europe.</b> Compilation of grinding causes and practices for grinding at different inframanagers as basis for benchmark and standardisation. Identification of optimisation possibilities regarding rail grinding.		●			●	
<b>D4.5.2 Target Profiles.</b> Comparison of standard, special and antiheadcheck profiles used throughout Europe as a basis for standardisation.	●				●	
<b>D4.5.3 Input for LCC-calculations.</b> Identification of possibilities for improvements in defining grinding interventions. Identification of current grinding strategies throughout Europe. Outline of a strategy to move from corrective to preventive grinding. Identification of possibilities for improved grinding logistics. Identification of possibilities for improved grinding specifications.		●	●		●	●
<b>D4.5.4 Friction management methods.</b> Identification of current friction management methods and promotion of best practice.	●	●			●	●
<b>D4.5.5 Concluding grinding recommendations.</b> Identification of areas for improvement in grinding practices and a prioritisation of these. Definition of grinding approaches to avoid corrugation and RCF, respectively. Prescription on how a transition to a preventive cyclic grinding strategy is carried out. Recommendations on optimisation of logistics and contracting practices.		●	●		●	●
<b>D4.6.1 Report on the influence of the working procedures on the formation and shape of the HAZ.</b> Process for achieving flash butt welds with narrow heat affected zones with quantified effects. Process for achieving aluminothermic welds with narrow heat affected zones with quantified effects.		●	●		●	●
<b>D4.6.2 Report on the influence of working procedures and post treatment on static and dynamic fatigue behaviour.</b> Post treatment methods for aluminothermic welds with quantified effects.		●	●		●	●
<b>D4.6.4 Analysis of equipment design and optimisation of parameters for gas pressure welding.</b> Requirements for gas pressure welding equipment for European railways.	●	●			●	
<b>D4.6.5 Laboratory test results and characterization of weld joints.</b> Laboratory investigation and classification of gas pressure welded joints.	●	●	●		●	
<b>D4.6.6 Supervision of weld properties in terms of rail profile, rail straightness and neutral temperature.</b> Track monitoring of innovative welds.		●	●		●	
<b>D5.1.1 Preliminary report on existing states of art for construction, maintenance and renewal activities and assessment of logistic constraints &amp; Definition document on logistics needs and constraints and definition of benchmarks.</b> Stand-alone report						
<b>D5.1.4 Preliminary report on conduct of interfaces between contractors and IM's and means of improvement.</b> An overview of contractors' opinions on current variations between infra-managers in procurement procedures with identification of areas for improvements and good practices. Identification of Europe-wide problems and possibilities in procurement procedures.		●			●	●



	Operational implementation			Research implementation		
	Standalone report Process/Product Codes/Norms	Database Tools	Impact on RAMS & Env. Database	Data/Knowledge Tools	Database	Impact on RAMS & Env. Database
D5.1.5 Final report on existing states of art for construction, maintenance and of logistic constraints. Summary of Europe-wide logistics and processes related to maintenance activities as basis for benchmarks and optimisations.	●					●
D5.1.6 Final report on conduct of interfaces between contractors and IM's and means of improvement. 14 contractors' views on current variations between infra-managers in procurement procedures with identification of areas for improvements and good practices. 7 infra-managers' views on current procurement procedures with identification of areas for improvements and good practices. Grouping of key findings in procurement practices in 7 clusters as areas of focus.	●	●			●	●
D5.1.7 GL Public report on construction, maintenance & renewal activities – conduct of interface between infra managers and contractors and suggested improvements. Summary of Europe-wide logistics and processes related to maintenance activities as basis for benchmarks and optimisations. Grouping of key findings in procurement practices in 7 clusters as areas of focus.	●					●
D5.2.1 Documented validation procedure. Stand-alone report	●					
D5.2.3 GL Improved logistics from innotrack solutions Assessment of innovative solutions derived in INNOTRACK from a logistics point-of-view. Assessment of innovative solutions derived in INNOTRACK from a logistics point-of-view. Assessment of innovative solutions derived in INNOTRACK from a logistics point-of-view. Identification of logistics constraints and main influencing variables regarding rail transportation and installation.	●	●			●	●
D5.3.1 First report on the logistics of support. Preliminary assessment of logistics of inclined piling. Preliminary assessment of logistics of steel-concrete-steel trackform. Preliminary assessment of logistics of embedded slab track.	●	●			●	●
D5.3.2 Final report on the logistics of support. Assessment of innovative solutions derived in INNOTRACK from a logistics point-of-view.	●	●			●	●
D5.4.1 First Report on the logistics of S&C. Review of logistics of current practices for maintenance and renewal. Preliminary evaluation of the implications of innovative solutions on logistics of S&C maintenance and renewal.	●	●				●
D5.4.2 Final report on the logistics of S&C. Assessment of innovative solutions derived in INNOTRACK from a logistics point-of-view.	●	●			●	●
D5.5.1 First Report on the logistics of rails. Comparison of logistics of long vs short rails. Identification of existing rail mills and fixed flash butt welding plants in western and central Europe.	●					●
D5.5.2 Final report on the logistics of rails. Assessment of innovative solutions derived in INNOTRACK from a logistics point-of-view. Identification of logistics constraints and main influencing variables regarding rail transportation and installation.	●	●			●	●

	Operational implementation			Research implementation		
	Standalone report Process/Product Codes/Norms	Database Tools	Impact on RAMS & Env. Database	Data/Knowledge Tools	Database	Impact on RAMS & Env. Database
D6.1.1 Incorporated Rules and Standards. Evaluation of use of LCC and RAMS at infra-managers, contractors, manufacturers, SMEs, branch organisations and academia as basis for benchmarks and optimisations. Identification of synergies between INNOTRACK and LICB. List of available standards, databases and software related to RAMS analysis.	●					●
D6.1.2 Models and Tools. CEvaluation of commercial models and tools for LCC/RAMS evaluation used among INNOTRACK partners as basis for benchmark and optimisation and standardisation. List of LCC models/tools as basis for benchmarks. List of RAMS models/tools as basis for benchmarks.	●				●	●
D6.2.1 Unique Boundary Conditions. Evaluation and recommendation of capital budgeting techniques for track related LCC analysis. Motivation and recommendation for discount rates and time horizons to consider in track related LCC analysis.	●				●	
D6.2.2 New and innovative tools and models: benchmark of LCC tools and required improvements. Benchmark of LCC tools as basis for investments.		●				
D6.2.4 Database and requirements (as input for WP6.5). Detailed breakdown of input data for LCC and RAMS analysis. Procedures to account for uncertainties via probabilistic analysis.					●	●
D6.3.1 Boundary conditions for RAM(S) analysis of railway infrastructure. Description of possible parameters to quantify the RAMS items. Definition of RAMS boundary conditions for railway infrastructures and impact on RAMS parameters.		●			●	●
D6.3.2 Requirements for RAMS-analysis of railway infrastructure regarding deterioration rates, influence functions, statistical methods, monitoring method, etc. Description of operational RAMS analysis at infra-managers and in industry as basis for adoption and improvements.					●	●
D6.3.3 Necessary developments of RAMS technologies. Description of current use of RAMS analysis at infra-managers as basis for adoption, benchmarks and optimisation. Identification of necessary development for the different IMs as basis for knowledge transfer etc.	●					●
D6.4.1 Key values for LCC and RAMS in contracts. Review of the most commonly used key values to describe RAMS and LCC, and their relevance for INNOTRACK related items. Identification of needs for identifying measureable key values to develop or set objectives for.		●			●	●
D6.4.2 Monitoring methods for LCC and RAMS issues defined in the contract taking into account cost-benefit analysis. Overview for systems for obtaining indata for LCC and RAMS analyses.		●			●	●
D6.5.1 Modular LCC/RAMS models for SP2 to SP5. Identification and mitigation of cost driver based on LCC analyses for SP2 to SP5 with technical and economical verification of the solutions. Optimization of track constructions or track components regarding technical and economic requirements. Decrease of Life cycle costing (LCC).	●	●			●	●

	Operational implementation			Research implementation		
	Standalone report Process/Product Codes/Norms	Database Tools	Database Tools	Data/Knowledge Tools	Impact on RAMS & Env. Database	
D6.5.3 <b>Comparable LCC-analysis for SP2 – 5 regarding WP 6.2 and 6.3.</b> Comparison of different systems and delivery of necessary information for technical and economical decisions. Overview of analysed and compared systems/products with indication of: optimisation of maintenance for low LCC, technical performance (RAMS parameter), best piont in time for maintenance, best practise.	●		●	●	●	●
D6.5.4 <b>Guidance for LCC and RAMS analysis.</b> LCC/RAMS guidance for technicians and controller among INNOTRACK partners.	●	●	●		●	●
D7.1.1 <b>Set up project private and public web-site.</b> Considerations in designing a graphical profile and setting up a website as basis for future projects.			●			
D7.1.2 <b>Set up the Dissemination Platform.</b> Outline of dissemination platform as input for future projects.			●			
D7.1.3 <b>Planning Report: set up Network of Industries and Infrastructure Managers.</b> Stand-alone report						
D7.1.4 <b>Report on the dissemination activities and proposal for further actions/update.</b> Description of dissemination strategies as input for future projects.			●			
D7.1.5 <b>Identification of relevant codes and correlation to INNOTRACK results.</b> Overview of the regulatory system in Europe. Overview of how INNOTRACK deliverables are influenced and influences the regulatory system and examples on how they can be merged into the system.	●		●			●
D7.1.6 <b>Summary of dissemination and training – lessons learnt.</b> Basis for continued implementation.			●			
D7.2.1 <b>Establishment of Training Platform.</b> The work contains the mapping of current training practices, identification of gaps and needs and establishment of training platform. Training and education in the field of LCC and RAMS for IM and track staff based on required training/needs.		●			●	
D7.2.2 <b>Report on training needs and plan for training programme.</b> Basis for training programme.			●			
D7.3.1 <b>Set up the Technical Review &amp; Standardisation Platform.</b> Stand-alone report						
D7.3.2 <b>Technical Review Platform.</b> Description of the review processes in INNOTRACK as input for future projects.			●			
D7.3.3 <b>Experience from review work.</b> Experience from INNOTRACK reviewing as input for future projects.			●			

Printed by  
International Union of Railways  
16, rue Jean Rey 75015 Paris - France  
July 2010  
Dépôt légal July 2010

ISBN 978-2-7461-1850-8

The track structure, rails, switches and crossings account for more than 50% of maintenance and renewal costs for the rail industry. To improve the competitiveness of rail transportation, the cost-efficiency of these areas needs to be addressed.

This the background to INNOTRACK, an integrated research project funded by the European Commission's 6th research framework programme. Running from September 2006 to December 2009, INNOTRACK has developed a multitude of innovative solutions in the areas of track substructure, rails & welds, and switches & crossings. The solutions have been assessed from technical, logistics and life cycle cost point of views.

This Concluding Technical Report of INNOTRACK includes an overview of the project. It further details implementable results, and clusters them into "highlight" areas. In addition, the book acts as a "key" to the vast amount of information from INNOTRACK: All sections refer to project reports where more information can be found.



INTERNATIONAL UNION  
OF RAILWAYS



THE EUROPEAN RAIL INDUSTRY



[www.innotrack.eu](http://www.innotrack.eu)



SIXTH FRAMEWORK PROGRAMME